

Dan-Am Co.[®] Catalog 25

Rev. 2016

Spray Guns | Cup Systems | Breathing Protection | Filtration | Accessories



DanAmAir[®]

SATA

and other equipment offered by Dan-Am Co.

***Dan-Am Co. is the Exclusive Independent Distributor
of SATA Products in the US and Puerto Rico***

This catalog also contains non-SATA products that are offered by Dan-Am Co.
only in its capacity as an independent entity operating on its own.

Table of Contents

General Shipping Information	1	Accessories for SATA spray guns	62-66	Filtration	126-138
Application Recommendations for Spray Guns	2-3	SATA® adam™ 2	62-63	SATA® filter 414™/424™/434™/464™	128-129
Cutaway Model of SATAjet 5000 B	4	Air Micrometers	63	SATA® filter 444™/484™	130-131
Application Recommendations for Cup Systems	5	SATA care set, SATA cert, Quick Coupling, Nipples, Gun Holders, Strainers, Dosenboy Spray gun cleaning brushes, Viscosity cup, Air tester, Air cap protectors	64-66	SATA® filter 222™/242™/244™/284™	132-133
Application Recommendations for Breathing Protection	6	Spray gun cleaning & maintenance	67	Accessories for SATA® filters, Manifold, Point of use reg., In-line air filter, Auto discharge, Air tester, Air check test kit.	134-135
Application Recommendations for Filtration Technology	7	Viscosity cup conversion chart	68	SATA Filter Timer	135
Application Recommendations for Accessories	8	Test air cap instructions	69	Filter head connection, 2011.	136
Dan-Am Paint Spray Equipment	9-10	SATA Calculator, Helpful Tips & Remedies, Metric Conversion Chart.	70	SATA® filter 400 series cutaway	137
Dan-Am Terms and Conditions	200	Automatic and Robotic spray guns	71-95	S.A.M.S. Supplied Air Monitoring System	138
Warranty information	201	Auto & ROB Features.	72-73	Accessories	139-157
Spray Guns	11-95	SATAjet® 3000 ROB RP®/HVLP	74-75	SATA® clean RCS™	140-141
SATAjet® 5000 B RP®/HVLP	12-13	Quick Change Adapters	76-78	SATA® dry jet™ 2	142
SATAjet® 4000 B RP®/HVLP	14-15	SATAjet® 3000 A RP®/HVLP	80-81	SATA® dry jet™	143
SATAminijet 4400 B	16-17	SATAjet® 1000 A RP®	82-83	SATA® dry jet™ stand	144
SATAjet® 3000 K RP®/HVLP	18-19	SATAjetminijet® 1000 A RP®/HVLP	84-85	Dan-Am blow gun stand	145
SATAjet® 3000 K spray mix	20-21	SATAjetminijet® 1000 A ROB RP/HVLP.	86-87	SATA blow guns, Sand blasting & Dosen-Boy	146-147
SATAjet® 1000 B RP®/HVLP	22-23	SATAminijet® 1000 A S HVLP.	88-89	Rust proofing Equipment	148-150
SATAjet® 1000 K RP®/HVLP	24-25	SATAjet® LPS 2000 RP®	90-91	SATA® HKU pump & Barrel pumps.	151
SATAjet® 1000 K Specialty	26-27	SATAjet® 3000 A spray mix	92-93	SATA® vario top spray™	152-156
K D RP		SATAjet® Lab Test	94-95	Quick Couplings	157
K Slit Nozzle		Cup Systems	96-110	Dan-Am Co.® Products.	158-198
K RP KK HKU Undercoating		SATA® RPS™ The Original	98	Dan-Am Air	160-161
SATAjet® 1000 H RP®/HVLP	28-29	Notes	99	Carbon Monoxide Monitors	162-163
Pressure fed material and air connection	30-31	SATA® RPS™ Disposable Cup System	100-101	Dan-Am Cabinets and spray gun holders	
Nozzle Extensions & Pressure fed accessories (strainers).	32-33	Accessories for SATA® RPS™	102	Electric drain valve	164
SATAjet® 100 BF RP®/HVLP		Adapters for SATA® RPS™	103	Dan-Am Kneeler, Hosemate	165
SATAjet® 100 B P	34-35	SATA RPS dispenser	104-105	Dan-Am Air Vac	166
SATAminijet® 1000 K RP/HVLP	36-37	Gravity Flow and Siphon Cups	106-107	Dan-Am Hoses	167
SATAminijet® 1000 H RP/HVLP	38-39	Glass Siphon and cup adapters.	108	Easy Flex Panel Paint Stand	168-171
SATAjet® 20 B.	40-41	SATA® BVD™.	109	Dan-Am Handy Stand	172-173
SATAgraph™ 1/2/3.	42-43	SATA® Agitator cup	110	Dan-Am Pressure Pots	174-175
SATAgraph™ 4	44-45	Breathing Systems	111-125	Dan-Am 10-20 L Pressure Tank	176-179
Spare Parts breakdown gravity fed sprayguns	46-47	Breathing Protection w/Activated Charcoal Belt	112	Dan-Am Pressure Regulators	180-181
Nozzle Sets for Older spray gun models.	48-49	Breathing Protection w/Industrial Belt Valve.	113	Dan-Am 7232 High Pressure Pump	182-185
If your spray gun is not listed, please visit www.satausa.com for more spare parts.		SATA® vision™ 2000 w/Activated Charcoal Belt	114-115	Dan-Am 2710 Medium and 2733 High Pressure Pump	186-189
SATAjet® 90-2.	50-51	SATA® air star C™ w/Activated Charcoal Belt	116-117	Dan-Am Air Assist Pump Sys. Order Form	190
SATAjet® 3000 B RP®/HVLP	52-53	SATA® vision™ 2000 w/Industrial Belt Valve.	118-119	Dan-Am 5 Gallon Agitator Lid.	191
SATAjet® 2000 B RP®/HVLP	54-55	SATA® air star C™ w/Industrial Belt Valve.	120-121	Sales and Demo Support/cases	192
SATAminijet® 3000 B HVLP	56-57	Accessories for SATA® vision™ 2000, air star C™ Air warmer, Tear offs, Linings, Sweat bands, Top Air Humidifier, Belt support straps,	122-123	Dan-Am Paint Suits.	193
SATAjet® KLC RP®/HVLP, SATAjet® KLC P	58-59	SATA® air star F™	124-125	SATAwear	194
SATAjet® B (SATAjet® GR)	60-61			Dan-Am Air Compressor.	195

General Information

DAN-AM Customer Service

Hours of Operation

Monday - Thursday 7:00 a.m. to 6:00 p.m. (central time)

Friday 7:00 a.m. to 5:00 p.m. (central time)

Phone orders	800-533-8016
Telefax orders	800-633-SATA (7282)
Int'l Telefax	507-346-7481
E-mail orders	order@satausa.com
Service/questions	800-533-8016

E-mail: satajet@satausa.com • www.satausa.com

We offer UPS delivery service. All orders are usually invoiced and packaged the same day, depending on the status of your account. We cannot guarantee any "add-ons" to original order or air shipments received after 12:00 noon, central time. UPS pick-up varies between 3:00 p.m. to 5:00 p.m.



UPS Next Day Air (red)

Air freight guaranteed to be delivered to most destinations the next business day (contiguous 48 states only). Saturday delivery available at an extra charge.

UPS Second Day Air (blue)

Air freight guaranteed to be delivered to most destinations the second business day (contiguous 48 states only).

UPS Three Day Select (orange)

Delivery guaranteed to arrive at most destinations in three business days (contiguous 48 states only).

UPS Ground

Delivery via truck between 1 to 5 days (contiguous 48 states only).

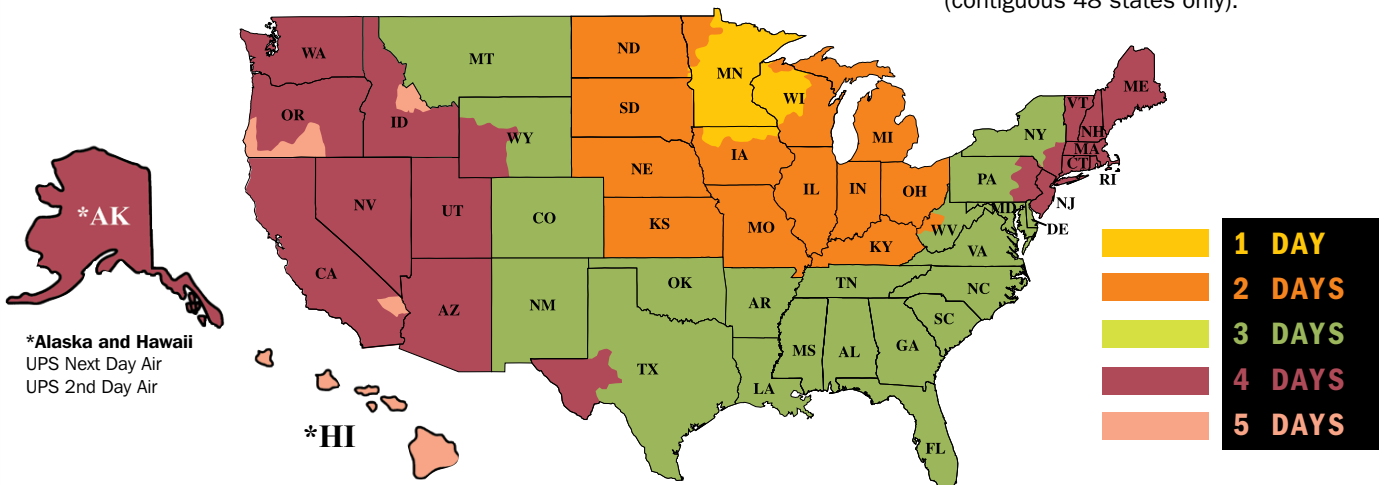

*Alaska and Hawaii
UPS Next Day Air
UPS 2nd Day Air

Service to some remote areas may require additional days.











Distributed by Dan-Am Co.® Member ASA
One SATA Drive, PO Box 46, Spring Valley, MN 55975





*Puerto Rico
UPS Next Day Air
UPS 2nd Day Air





Application Recommendations for Spray Guns

1. High Performance Spray Guns			
Spray gun type	Fields of applications	Operating Mode	
<p>SATAjet 5000 B HVLV/ RP Page 12 13</p> 	<p>For top coat applications meeting highest requirements in terms of color match precision, uniform distribution and gloss. Ideally suited for car refinishing, interior design, wood coating and the furniture industry.</p>	<ul style="list-style-type: none"> Optionally available in HVLV low pressure or optimised high pressure RP technology Round/flat spray control Material flow control Air micrometer Gravity flow cup with QCC bayonet lock or RPS disposable cup Optional feature: integrated digital pressure gauge 	
<p>SATAjet 4000 B HVLV/ RP Page 14 15</p> 	<p>For top coat applications meeting highest requirements in terms of color match precision, uniform distribution and gloss. Ideally suited for car refinishing, interior design, wood coating and the furniture industry.</p>	<ul style="list-style-type: none"> Optionally available in HVLV low pressure or optimised high pressure RP technology Round/flat spray control Material flow control Air micrometer Gravity flow cup with QCC bayonet lock or RPS disposable cup Optional feature: integrated digital pressure gauge 	
<p>SATAjet 3000 K HVLV/ RP Page 18 19</p> 	<p>Ideally suited for coating large areas, e.g. on commercial vehicles, or application of textured paints with air atomizing technology.</p>	<ul style="list-style-type: none"> To be used in combination with paint pressure tanks or low pressure pumps, i.e. SATA vario top spray double membrane pump Same functional features as 1.1 	
<p>SATAjet 3000 K spray mix Page 20 21</p> 	<p>Ideally suited for coating large areas in the furniture and metalworking industry</p>	<ul style="list-style-type: none"> To be used in combination with high pressure air assisted pumps (max. 250 bar), i.e. SATA shark or SATA dolphin Round/flat spray control Air micrometer 	
2. Universal Spray Guns for Industry			
<p>SATAjet 1000 B HVLV/ RP Page 22 23</p>  <p>SATAjet 1000 H RP Page 28 29</p> 	<p>For the application of a wide array of different materials, from primer materials and paint to glue and separating agents in craft and industry. A comprehensive range of accessories is available for this spray gun, including extensions, slit nozzles, and nozzle set-ups for glue application.</p>	<ul style="list-style-type: none"> Optionally available in HVLV low pressure or optimised high pressure RP technology. Round/flat spray control Material flow control Air micrometer Gravity flow cup with QCC bayonet lock or suction cup 	
<p>SATAjet 1000 K HVLV/ RP Page 24 25</p> 	<p>Same field of application as 2.1., but for coating large areas.</p>	<ul style="list-style-type: none"> To be used in combination with paint pressure tanks or low pressure pumps, i.e. SATA vario top spray Same functional features as 2.1 	
<p>SATAjet 1000 K Specialty Guns K D, Slit Nozzle KK HKU Rustproof Page 26 27</p> 	<p>Specialty spray guns for the application of adhesives, textures and rustproofing material</p>	<ul style="list-style-type: none"> To be used in combination with paint pressure tanks or low pressure pumps, i.e. SATA vario top spray Same functional features as 2.1 	

Application Recommendations for Spray Guns

<p>SATAMinijet 1000 K HVLP/ RP Page 36 37</p>		<p>Same field of application as 2.1, but for coating large areas.</p>	<ul style="list-style-type: none"> To be used in combination with paint pressure tanks or low pressure pumps, i.e. SATA vario top spray Same functional features as 2.1
<p>SATAMinijet 1000 H HVLP/ RP Page 38 39</p>		<p>Same field of application as 2.1, but for coating large areas.</p>	<ul style="list-style-type: none"> To be used in combination with paint pressure tanks or low pressure pumps, i.e. SATA vario top spray Same functional features as 2.1

3. Spray Guns for Primer and Filler Applications

Spray gun type	Fields of applications	Operating Mode	
<p>SATAjet 100 B F HVLP/ RP Page 34 35</p>		<p>Application of primer and filler materials in craft and industry</p>	<ul style="list-style-type: none"> Optionally available in HVLP low pressure or optimised high pressure RP technology Round/flat spray control Material flow control Air micrometer Gravity flow cup with QCC bayonet lock
<p>SATAjet 100 B P Page 34 35</p>		<p>Application of polyester filler and sprayable putty</p>	<ul style="list-style-type: none"> High pressure spray gun with shortened air cap horns, without air micrometer Same functional features as 3.1, without air micrometer

4. Universal Spray Guns for Industry

<p>SATAMinijet 4400 B HVLP Page 16 17</p>		<p>Spray gun for small paint jobs, e.g. spot repair and touch-ups in the automotive sector or custom design in craft and industry. Also perfectly suitable for the application of separating agents.</p>	<ul style="list-style-type: none"> HVLP low pressure atomisation Round/flat spray control for left and right handed painters Reusable cup with mini QCC bayonet lock Material flow control Air micrometer
<p>SATAjet 20 B Page 40 41</p>		<p>Spray gun for custom design in craft and industry, calligraphy, patination</p>	<ul style="list-style-type: none"> Exclusively available with round spray nozzles Reusable cup
<p>SATAgaph 1/2/3 Page 42 43</p>		<p>Spray guns for custom design in craft and industry</p>	<ul style="list-style-type: none"> Airbrush guns with gravity or suction cups Exclusively available with round spray nozzles With double-action function
<p>SATAgaph 4 B/S/H Page 44 45</p>		<p>Spray guns for custom design in craft and industry</p>	<ul style="list-style-type: none"> Airbrush guns with gravity, side or suction cups Exclusively available with round spray nozzles With double-action function Reversing nozzle for fine detail work

5. Automatic & Robotic Guns

Spray gun type	Fields of applications
<p>5.1 SATA automatic and robotic Page 71 - 95</p>	 <p>Industrial application of varying amounts of materials. Please inquire for specific usage and combinations available</p>

Cutaway model SATAjet 5000 B

Cutaway model SATAjet 5000 B

Robust air cap of chrome-plated brass with new **QC™** air cap thread for quick change with only one turn.



Air cap ring:

green = HVLP technology

blue = RP technology



Fluid tip and paint needle made of corrosion resistant stainless steel.

Material passage (red).

Air passage (blue).

Replaceable air distribution insert.

Fluid tip sealing ensuring minimal cleaning effort and safe colour change.

Low maintenance, self-adjusting seals at air piston and paint needle

Ergonomically designed trigger with paint needle protection ensuring increased lifetime of the paint needle packing.

Easy clean corrosion-resistant pearlchrome™ gun surface.

Option: Digital pressure display for perfect colour match.



CCS™ – Colour Code System. For the convenient identification of your spray gun.



QCC™ – Quick Cup Connector. Bayonet cup connection. Ensures quick and clean cup changes as well as easy cleaning.

Gun suspension hood for convenient storage.

Control elements can be perfectly adjusted even when wearing gloves.

Improved material flow control with counter nut.

Air micrometer for the adjustment of the atomization air. Highest precision with digital pressure gauge (optional).

Spray fan control allowing fine adjustment with a half turn only

Ergonomically shaped gun handle.









Special internal nickel plating

Air connection G 1/4 male thread with optionally available swivel joint.





Warranty. Top quality is not enough - we guarantee it: for three years!

Application Recommendations for Cup Systems

Cup Systems		
Cup type / capacity	Fields of application	Connection
<p>SATA RPS mixing cup 0,3 l / 0,6 l / 0,9 l Page 100-101</p> 	<p>Disposable gravity cup with paint sieve for frequent colour changes. For mixing, painting and storing. No adapters required for all current SATA spray guns</p>	<ul style="list-style-type: none"> • With QCC bayonet lock and male thread • Adapters for older SATA spray gun models and spray guns from other manufacturers are available
<p>SATA RPS Adapters Page 103</p> 	<p>Use RPS adapters for spray guns without QCC adapters. Also for paint guns of other spray gun manufacturers</p>	
<p>SATA RPS Dispenser Page 104-105</p> 	<p>DRPS dispenser to keep all your RPS disposable cups, lids, and sieves in an organized location.</p>	
<p>SATA reusable cup 63 ml / 15 ml / 0.3l / 0.6 l / 0.75 l / 1.0 l Page 106 - 107</p> 	<p>Reusable plastic or aluminum gravity flow cups for SATA spray guns</p>	<ul style="list-style-type: none"> • With QCC bayonet lock and male thread or with female thread for older SATA spray gun models
<p>SATA glass reusable cup 25 ml Page 108</p> 		
<p>SATA cup adapters Page 108</p> 		
<p>SATA BVD adaption kit 0,7 l Page 109</p> 	<p>Pressurised reusable aluminum gravity flow cup for the application of high-viscosity materials</p>	<ul style="list-style-type: none"> • With QCC bayonet lock and male thread or with female thread for older SATA spray gun models
<p>SATA agitator cup 0,7 l Page 110</p> 	<p>Reusable aluminum gravity flow cup with integrated agitator for the application of materials with settling components, e.g. effect paints. Agitator with air regulation valve for speed adjustment</p>	<ul style="list-style-type: none"> • With QCC bayonet lock and male thread

Application Recommendations for Breathing Protection

Breathing Protection

Respirator type		Fields of application/function
SATA vision 2000 Page 112-115, 118		Full face respirator protects the head incl. hair and neck / independent from ambient air (air supplied). Please note the legal requirements of your region.
SATA air star C Page 113, 116, 117, 120		Half mask protects mouth and nose / independent from ambient air (air supplied). Protective goggles are recommended. Please note the legal requirements of your region.
SATA air star F Page 124, 125		Half mask to protect the mouth and nose area / dependent on ambient air (filtering mask). With pre-filter disks to extend the lifetime of the filter cartridges. It is recommended to wear protective goggles. Please note the legal requirements of your region.

Cutaway SATA vision 2000



Head/chest cover with velcro closure; breathable, solvent-resistant, lint-free and flame retardant.

Individually adjustable head strap to allow greater wearer comfort.

Adjustment screw allowing to fix the visor.

Lightweight, robust liftable visor.

Sweat band made of microfiber velour, dermatologically tested; easy to replace to ensure highest hygiene standards; with foam insert for enhanced wearer comfort.

Hygienic quick exchange hood inlays.

Special single visor foil to prevent reflections and distortions leading to colour deviations; quick and easy to change.

Breathing air hose with sound absorber for fresh air supply.

■ SATA® Belt Units
Adjustable and cushioned;
a) with activated charcoal filter to provide quality breathing air.
b) Industrial belt unit

■ SATA® air warmer
Adjustable breathing air warmer to increase the temperature by max. approx. 55° F, attaches to the belt unit.

Sound absorber

Application Recommendations for Filtration Technology

Filtration Technology

Filter type

SATA filter
424 / 434 / 444 /
464 / 484
 Page 128 - 131



Fields of application/function

- Filter units for the use in paint booths
- Ambient temperature: **up to max 248 °F,**
or up to max 140 °F when using activated charcoal (3 stage)
 - Modular structure of up to 3 filter stages incl. activated charcoal filter
 - Meets highest requirements for high-grade compressed air (100 % technically clean air)
 - Air flow: **129 cfm @ 90 psi**

SATA filter
222 / 224 / 244 /
284
 Page 132



- Filter units for the use in paint booths
- Modular structure of up to 3 filter stages incl. activated charcoal filter
 - Ambient temperature: **up to max 120 °C,**
or up to max 140 °F when using activated charcoal (3 stage)
 - Meets requirements for high-grade compressed air (100 % technically clean air)
 - Air flow: **70 cfm @ 90 psi**

Cutaway model SATA filter 484

Large pressure adjustment screw allowing the exact regulation of the work pressure.

Maintenance free pressure regulation valve.

Air inlet G 1/2 female thread : Air flow > 129 cfm at 87 psi (for 400 series)

First filter stage:
 ■ Low maintenance cyclone separates condensate and oil droplets

■ Sintered filter to separate particles > 5 micron; exchange interval: 6 months

Automatic condensate discharge valve - high operating safety, low service effort.

Condensate discharge hose.

Air pressure gauge for pressure difference display (control of fine filter saturation).

Air outlet module.

Optional air outlet G 1/2 female thread

Air outlets with ball valves and connections w/ G 1/4 male threads



Filter housing with easy clean surface.

Second filter stage:
 ■ Fine filter cartridge to separate particles > 0.01 micron; separation efficiency 99.998 %; exchange interval: 6 months

Third filter stage:
 ■ Activated charcoal cartridge to eliminate oil vapors when using air-supplied breathing masks and for the application of waterborne paints; Exchange interval every 3 months.

Application Recommendations for Other Devices / Accessories

1. Spray Gun Cleaning	
Type of Device	Fields of application/function
SATA clean RCS Page 140 	<ul style="list-style-type: none"> • Rapid cleaning system for intermediate cleaning of spray guns for quick colour changes when using disposable cups, e.g. SATA RPS • Suitable for waterborne and solvent-based paint systems

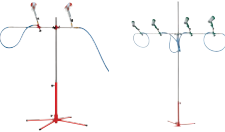
2. Dry-Blowing Systems	
Type of Device	Fields of application/function
SATA dry jet 2 Page 142 	<ul style="list-style-type: none"> • Essential for a reduced flash-off time, produces larger, even air flow in the injector zone • Ideally suited for smaller paint jobs, as expensive booth heating times are being avoided
SATA dry jet Page 143 	<ul style="list-style-type: none"> • Accelerated drying for surfaces painted with waterborne materials • Ideally suited for smaller paint jobs, as expensive booth heating times are being avoided
SATA dry jet jumbo Page 142 - 143 	<ul style="list-style-type: none"> • Use of multiple blow guns enhances productivity • Complete with four blow guns for larger surfaces e.g. for commercial vehicles

3. Bodyshop Equipment	
Type of Device	Fields of application/function
SATA Blow Guns Page 146 	<ul style="list-style-type: none"> • To blow-off dust and particles - low air consumption, high efficiency • Sturdy and very durable • Different versions with special nozzle set-ups available
Grit Blasting Equipment Page 146 	<ul style="list-style-type: none"> • Grit blasting guns with hard metal insert to remove rust efficiently and quickly • Ideal for difficult to access areas. • Injector suction principle optionally with hand-held gun or large containers
Dosenboy Page 146 	<ul style="list-style-type: none"> • Used to remove lids from tins • Saves valuable storage space before disposal
Rust Proofing Equipment HKU pump Page 148 - 151 	<ul style="list-style-type: none"> • Pressurised cup spray gun for cavity preservation and underbody protection of all vehicle types. Different cavity wand systems are available. • Fine atomisation even with the application of high-viscosity materials by pressurization with up to 150 psi





4. Material Supply for Spray Guns	
Type of Device	Fields of application/function
1.1 SATA vario top spray Page 152 - 156 	<ul style="list-style-type: none"> • Pneumatically operated low pressure double diaphragm pump for air atomizing pressure fed spray guns or material supply for automatic spray guns, directly out of the original container

Dan-Am Accessories

Dan-Am Products		
Type of Device		Fields of application/function
Dan-Am Air Page 160 -161		DanAm Air is a an aluminum compressed airlines that is easily installed with the push to connect technology, is modular, can be connected to existing airlines.
Carbon Monoxide Monitors Page 162 -163		Both AC and DC, wall mount and portable CO monitors meet the OSHA and NIOSH regulations. Alert at 10 ppm, both audible and visible alarm and led readouts.
Dan-Am Cabinets and Spray Gun Holders Page 164		Unique locking cabinets to store valuable SATA spray guns. Both single and dual door options. We also offer a full line of gun holders useful in any shop.
Spray gun holders Page 164 (pg 64)		Single to multiplies of 3 holder for spray guns.
Electric Drain Valve Page 164		Inexpensive way to insure your air tank or airline system is purged of condensation. Two timers set how often it drains, and purge cycle length
Dan-Am Kneeler Page 165		Save your knees, Dan-Am Kneeler is here for the jobs that are hard on your knees.
Hosemate Page 165		Designed to keep your hoses from kinking at crucial painting times, also great for hanging this out of the way.
Dan-Am Air Vac Page 166		This handy tool helps eliminate dirt & debris from your wet clearcoat or topcoat. Saves great amount of time and redo work later.
Dan-Am Hoses Page 167		Hoses for everything from breathing air to high pressure fluid and air combination hoses for painting
Easy Flex Paint Stand Page 168 -171		Flexible efficient easy to use panel stands to paint panels, bumpers, wheels and small parts from nearly every direction
Dan-Am Handy Stand Page 172 -173		The multi-directional, multi purpose stand.
Dan-Am Pressure Pots Page 174 - 175		High quality pressure pots for fleet and commercial use. Include options for pressure tank and SATA spray gun combinations and hoses
Dan-Am 10-20 L Pressure Tanks Page 176 - 179		Pressure tanks and hoses with various options for single and dual gauges, dingle and dual guns and economical for the value minded budget
Dan-Am Pressure Regulators Page 180 -181		Pressure regulators for pressure pots and tanks for a variety of sizes and setups
Dan-Am 7232 High Pressure Pump Page 182 - 185		Stainless Steel high pressure air assisted airless pump for use with high viscosity or multiple gun applications
Dan-Am 2710 Med. and 2733 High Pres. Pump Page 186 -189		10:1 and 33:1 stainless pumps for use with a variety of viscosities and products. 27cc lower allows up to 2 gun connections
Dan-Am Air Assist Pump System Order Form Page 190		Makes it easy to determine the pump you want, and place an order
Dan-Am 5 Gallon Agitator Lid Page 191		Complete stainless steel suitable for waterborne or solvent materials. Durable GAST Air Motor construction with complete speed variability
Dan-Am Sales and Demo Support/Cases Page 192		Extremely durable cases to provide protection and ease of transporting your SATA spray guns. Various sized cases available for any needs
Dan-Am Paint Suits Page 193		A variety of sizes and design paint suits from economical to professional series . Flexible for comfort and anti-static to keep your work and you clean
Dan-Am SATAwear & Promo Items Page 194		Wear SATA gear proudly. Check with us often for additions to the Dan-Am and SATAwear products

Continued on page 10

Dan-Am Products (continued from page 9)

<p>Dan-Am Pro Airbrush Compressor Page 195</p>		<p>Dan-Am Pro airbrush compressor, no pulsating air supply for all your airbrush or artbrush</p>
<p>Dan-Am Pro Stencils/Sticky Mickey Masking Page 196 -197</p>		<p>Creative and functional as well as high quality at a great low price stencils and Sticky Mickey masking help all your custom work look amazing</p>
<p>Dan-Am How-To DVDs and Books Page 198</p>		<p>Assortment of how-to books and DVD from various artists and painters. Learn to do it from the pros using SATA equipment</p>
<p>Dan-Am Brochures, Decals and Posters Page 199</p>		<p>Complete range of product brochures, posters and decals from SATA and Dan-Am Company</p>

Spray Guns



Design by
**PORSCHE DESIGN
STUDIO**

SATAjet® 5000 B RP®/HVLP



SATAjet 5000 B – the new, versatile high performance spray gun

SATA's new high performance spray gun, the SATAjet 5000 B is characterized by its supreme flexibility. The development process focused on creating a more versatile spray gun in regard to inlet pressure, application distance and further improved adaptability to specific requirements of the different paint systems available. The SATAjet 5000 B allows the painter to flexibly set the inlet pressure in a range between 7 and 32 psi with a gun distance between 4 to 8.5 inches, depending on material, ambient conditions and personal preferences, in order to achieve optimum finishes.

Another quite remarkable enhancement concerns the ergonomics of the SATAjet 5000 B. The gun handle of the digital version, for instance, is identical in size and shape to the standard spray gun. The air micrometer is now considerably larger and much easier to regulate. The modern design of the SATAjet 5000 B has been created in cooperation with the Porsche Design Studio, Zell am See (Austria). The SATAjet 5000 B is finished with a satin-gloss pearlchrome™ surface which is corrosion-resistant and easy to clean

SATAjet 5000 B RP

Technical Data



www.sata.com/SATAjet5000B



Inlet pressure
Field of application: 7 psi - 29 psi
Compliant: max. 29 psi
Air consumption at 29 psi: 10.2 cfm
Spray distance
Field of application: 3.9" - 8.3"
Recommended: 6.7" - 8.3"

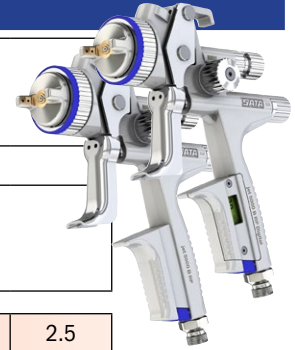

Nozzle	1.0	1.1	1.2	1.2W	1.3	1.4	1.6	1.8	2.0	2.5
---------------	-----	-----	-----	------	-----	-----	-----	-----	-----	-----

Standard with RPS disposable cup 0.3 l / 0.6 l / 0.9 l (each 1x) without swivel joint

Art. No.	-	215640	209858	209866	209874	209882	209890	209908	209916	-
-----------------	---	--------	--------	--------	--------	--------	--------	--------	--------	---

Nozzle	1.0	1.1	1.2	1.2W	1.3	1.4	1.6	1.8	2.0	2.5
---------------	-----	-----	-----	------	-----	-----	-----	-----	-----	-----

DIGITAL with RPS disposable cup 0.3 l / 0.6 l / 0.9 l (each 1x) without swivel joint

Art. No.	210138	210146	210153	210161	210179	210187	210195	210203	210211	-
-----------------	--------	--------	--------	--------	--------	--------	--------	--------	--------	---

Nozzle set

Art. No.	210245	210252	210260	210278	210286	210294	210302	210310	210328	210336
-----------------	--------	--------	--------	--------	--------	--------	--------	--------	--------	--------

SATAjet 5000 B HVLP

Technical Data



www.sata.com/SATAjet5000B



Inlet pressure
Field of application: 7 psi - 29 psi
HVLP: max. 29 psi
Air consumption at 29 psi; 15.2 cfm
Spray distance
Field of application: 3.9" - 8.3"
Recommended: 3.9" - 5.9"

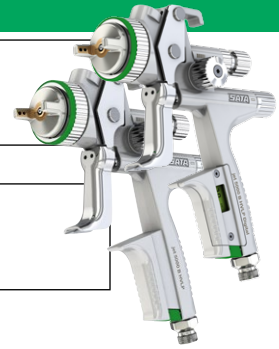

Nozzle	1.0	1.2	WSB	1.3	1.4	1.5	1.7	1.9	2.2
---------------	-----	-----	-----	-----	-----	-----	-----	-----	-----

Standard with RPS disposable cup 0.3 l / 0.6 l / 0.9 l (each 1x) without swivel joint

Art. No.	210732	210740	210757	210765	210799	210823	210831	210849	210856
-----------------	--------	--------	--------	--------	--------	--------	--------	--------	--------

Nozzle	1.0	1.2	WSB	1.3	1.4	1.5	1.7	1.9	2.2
---------------	-----	-----	-----	-----	-----	-----	-----	-----	-----

DIGITAL with RPS disposable cup 0.3 l / 0.6 l / 0.9 l (each 1x) without swivel joint

Art. No.	211094	211110	211128	211136	211151	211193	211201	211219	Call
-----------------	--------	--------	--------	--------	--------	--------	--------	--------	------

Nozzle set

Art. No.	210955	210963	210971	210989	211011	211045	211052	211060	211078
-----------------	--------	--------	--------	--------	--------	--------	--------	--------	--------

Test Air Cap		215996	215988	215996	215988	215988			
---------------------	--	--------	--------	--------	--------	--------	--	--	--

Technical modifications and printing errors reserved

SATAjet® 4000 B RP®/HVL





Use for high-quality topcoat finishes in automotive or any other field of application. Superb finish results, along with a well-balanced, light-weight, ergonomic spray gun are a few of the design factors built into the SATAjet 4000 B. With enhanced atomization and a wider, softer fan, it delivers superior finish quality. Material distribution is improved and transfer efficiency far exceeds 65% required by legislation for both HVL and RP. With a newly designed nozzle concept, every paint system is safely and perfectly applied. With extremely uniform and soft spray fan, the material lays down smoothly, resulting in a top class finish.

With the new ergonomic design, the control elements can easily be adjusted. The fan control is now fully adjustable with only 1/4 of a turn from open to close. New trigger design with less trigger pull means the painter can use one, two or three fingers for fatigue-free work. The control adjustments and gun body have a high-gloss chrome finish for corrosion protection. Moreover, the material passages have a special coating to enhance internal corrosion protection making the SATAjet 4000 B suitable for waterborne or solvent base material.

The DIGITAL model with LCD readout integrated into the gun handle gives you a precise pressure setting to achieve exact color matches.



SATAjet 4000 B RP DIGITAL & Standard

 	Technical Data	Max Inlet Pressure: 32 psi.	Operating Pressure: 20-32 psi.
		Air consumption: 10.4 cfm at 29 psi	
		Spray distance: 6 3/4 - 8 1/4 in	
		Weight: 20 oz.	



Nozzle	1.0	1.1	1.2	1.2 W	1.3	1.4	1.6	1.8	2.0	2.5	
Standard gun with RPS demo pack											
Order No.	176974	171520	169979	169987	169995	170001	176990	177014	177030	177055	
DIGITAL gun with RPS demo pack											
Order No.	176982	171553	170019	170027	170035	170050	177006	177022	177048	177063	
Nozzle	1.0	1.1	1.2	1.2 W	1.3	1.4	1.6	1.8	2.0	2.5	
Nozzle Set											
Order No.	166991	167007	167015	167023	167049	167056	167072	167080	168625	168633	

SATAjet 4000 B HVL DIGITAL & Standard

 	Technical Data	Max Inlet Pressure: 29 psi.	Operating Pressure: 22-29 psi.
		Air consumption: 15.2 cfm at 29 psi	
		Spray distance: 10 - 15 cm / 4 in - 6 in	
		Weight: 20 oz.	

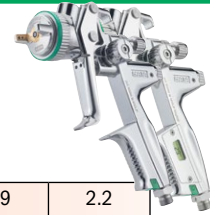

Nozzle	1.0	1.2	WSB	1.3	HC+	1.4	1.4HC	1.5	1.7	1.9	2.2
Standard gun with RPS demo pack											
Order No.	176891	170159	170167	170175	204230	170209	170217	170696	176917	176941	176958
DIGITAL gun with RPS demo pack											
Order No.	176909	166249	170357	170365	204354	170399	170407	170704	176925	176933	176966
Test Air Cap	171355			171348				Call			
Nozzle	1.0	1.2	WSB	1.3	HC+	1.4	1.4HC	1.5	1.7	1.9	2.2
Nozzle Set											
Order No.	166926	166934	166983	166942	200253	166967	171512	166975	168658	168666	168674
Specially Developed HVL Nozzles				1.3 C	1.3 LV						
Standard gun with RPS demo pack											
				170183	170191						
DIGITAL gun with RPS demo pack											
				170373	170381						
Test Air Cap				171348	171355						
Nozzle Set				166959	168641						

Technical modifications and printing errors reserved

Spare Parts SATAjet® 4000 B

Order No./Desc.	
240	Packing, air piston
1818	Snap ring, air cap
3426	Circlip, pin, ea.
3970	Seal, air micrometer
14605	Bushing, needle packing
14993	Spring, needle packing
15438	Kit, needle packing
17897	Spring, paint needle
19745	Swivel fitting, standard 1/4" air inlet
23275	Packing, needle
53470	Pad, rubber trigger
54775	Pad, rubber trigger, pk of 5
69872	O ring, fan control
82552	Kit, air piston service
86843	Piston, air rod
96875	Seal, inner cup
133934	O ring, fan control, pk of 3
133942	Bushing, air piston
133959	Kit, spring, pk of 3 each of #215806 & #17897
133967	Pin, air micrometer, pk of 3
133991	Packing, air piston, pk of 3
134098	Fitting, standard 1/4" air inlet, non-digital
136960	Packing kit
140582	Seal, Fluid Tip, pk of 5
164403	Air distribution ring, pk of 3
164405	Air distribution ring, pk of 5
164420	Air distribution ring, pk of 20
164459	Knob, fan control
164574	Screw, fan control
164623	Pin, upper trigger
164624	Pin, lower trigger
165928	CCS clips, pk of 4
165936	Tool kit
165944	Control Spindle, w/O ring
165951	Air distribution ring, pk of 3 w/extraction tool (#43638)
165977	Trigger kit
165993	Battery Kit w/cover and seal
166009	Kit, trigger sleeve
166017	Air micrometer (air flow control)
166025	Material flow control w/counter nut
166033	Knob, fan control w/screw
166058	Repair kit
166330	Trigger only
166371	Ring only, RP 4000 air cap
166389	Ring only, HVLP 4000 air cap
167882	Washer, tension spring
172429	Seal, air cap ring, pk of 5
215806	Spring, air piston

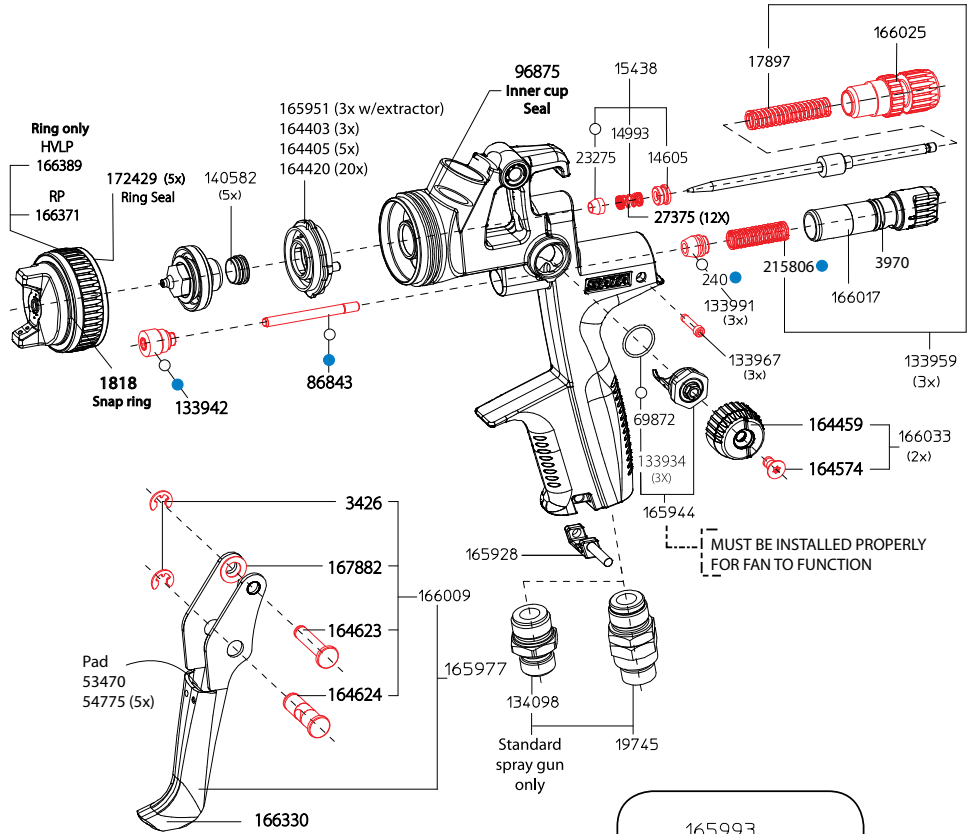

WARNING
 on DIGITAL GUNS
 Removing the DIGITAL air inlet tube or the DIGITAL display cover
 VOIDS WARRANTY
 It must be returned for service
 otherwise it will not function
 properly

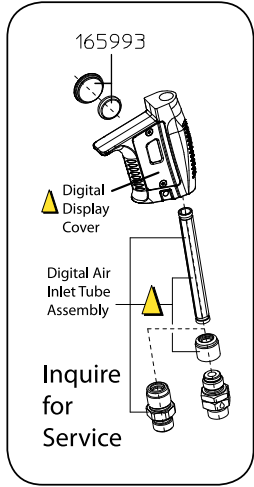

165936 Tool Kit	
901	Universal spanner wrench
3509	Cleaning brush
64543	Allen wrench
9647	Allen/Torx wrench T20
	Paint sieve
43638	Extraction tool
165928	CCS clip kit



Order No./Desc.
166058
Repair kit
<input checked="" type="radio"/> 82552
Air piston service set
<input type="radio"/> 136960
Sealing kit

Technical modifications and printing errors reserved



SATAmijet® 4400 B HVLP / RP®

SATAmijet 4400 B RP / RP SR (pending EPA approval)

Technical Data	Inlet pressure: 35 psi
	Air consumption at 7 cfm @ 35 psi
	Spray distance: 6-7 in



Nozzle	0.5	1.4	1.6	0.8 SR	1.0 SR	1.2 SR	Supplied with 2x 0.3l cups Uses std QCC cups
---------------	-----	-----	-----	--------	--------	--------	---

Standard / Spot Repair with RPS disposable cup 0.3 l (2x)

Art. No.	202382	198374	204156	202390	198358	198366	
-----------------	--------	--------	--------	--------	--------	--------	--

Nozzle	0.5	1.4	1.6	0.8 SR	1.0 SR	1.2 SR
---------------	-----	-----	-----	--------	--------	--------

Nozzle set

Art. No.	202408	201319	201327	201285	201293	201301	
-----------------	--------	--------	--------	--------	--------	--------	--

Test Air Cap	206466	206482	206474				
---------------------	--------	--------	--------	--	--	--	--

SATAmijet 4400 B HVLP / HVLP SR

Technical Data	Inlet pressure: 7.5-29 psi bar
	Air consumption at 4.2 cfm @ 29 psi
	Spray distance: 5-6 in



Nozzle	0.3	0.5	0.8	1.0	1.1	0.8 SR	1.0 SR	1.2 SR	1.4 SR	Supplied with 2x 0.3l cups Uses std QCC cups
---------------	-----	-----	-----	-----	-----	--------	--------	--------	--------	---

Standard / Spot Repair supplied with RPS disposable cup 0.3 l (2x)

Art. No.	204164	204172	204180	204198	204206	198168	198176	198184	198192	
-----------------	--------	--------	--------	--------	--------	--------	--------	--------	--------	--

Nozzle	0.3	0.5	0.8	1.0	1.1	0.8 SR	1.0 SR	1.2 SR	1.4 SR
---------------	-----	-----	-----	-----	-----	--------	--------	--------	--------

Nozzle set

Art. No.	201194	201202	201210	201228	201236	201244	201251	201269	201277	
-----------------	--------	--------	--------	--------	--------	--------	--------	--------	--------	--

Test Air Cap	206417	206425	206433	206441	206458				
---------------------	--------	--------	--------	--------	--------	--	--	--	--

198382	SATA design set with SATAmijet 4400 B HVLP nozzle 1.0 (state nozzle size)	
---------------	---	--

Reusable QCC PVC and aluminum cups sold seperately. Uses std QCC cups, no adapter required

Spray fan comparison

SATAmijet 4400 B HVLP SATAmijet 4400 B RP for standard applications		SATAmijet 4400 B HVLP SR SATAmijet 4400 B RP SR especially for spot repair applications:	
<ul style="list-style-type: none"> Lower risk of creating bright edges ("halos") Allows to apply very thin layers of paint 			

1.1 HVLP (at 29 psi)
Spray distance 6 in

1.6 RP (at 35 psi)
Spray distance 6.7 in

1.2 HVLP SR (at 29 psi)
Spray distance 6 in

1.2 RP SR (at 35 psi)
Spray distance 6.7 in

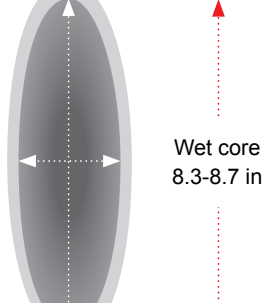
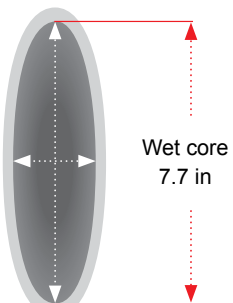
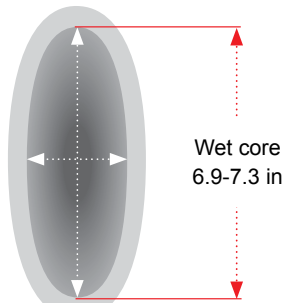
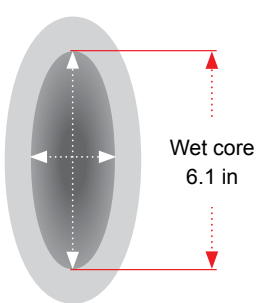

Technical modifications and printing errors reserved

Spare parts SATAmijnjet® 4400 B

Art. No./Descr.
3988
Strainer. 300 µm (20x)
3988-5
Strainer. 300 µm (5x)
16295
25 ml glass cup with plug-in cup
53033
25 ml glass cup with plug-in cup (5x)
58164
25 ml glass cup with blind lid (5x)
64022
PVC lid (3x)
133983
Air connection piece G1/4 male thread
197418
CCS Clips. green. blue. red. black (4x)
197467
Air distribution ring (3x), w/puller
197541
0.125 l QCC reusable plastic cup. cpl.
197558
Anti-drip device (4x)
198408
Air piston rod
198473
Trigger kit
198523
Air micrometer
198549
Spindle for round / flat spray control
198911
0.15 l QCC reusable aluminium cup. cpl.
199075
Screw cap with drip catcher ring and anti-drip device
199406
Material flow control with counter nut
199414
Packing for paint needle and air piston rod
199430
Adjustment screw (3x) for air micrometer
199448
Air piston head (3x)
199455
Sealing element (5x) for fluid tip
199463
Trigger sleeve kit
199471
Gasket (3x) for spindle
201467
Pressure spring (each 3x) for paint needle and air piston
200162
Control knob with screw each 2)
200220
Plug-in cup connection with QCC
200238
25 ml glass cup with plug-in lid (5x) and QCC plug-in connection (1x)
200907
Sealing ring (5x)
199398
Air cap ring complete RP
199380
Air cap ring complete HVLP

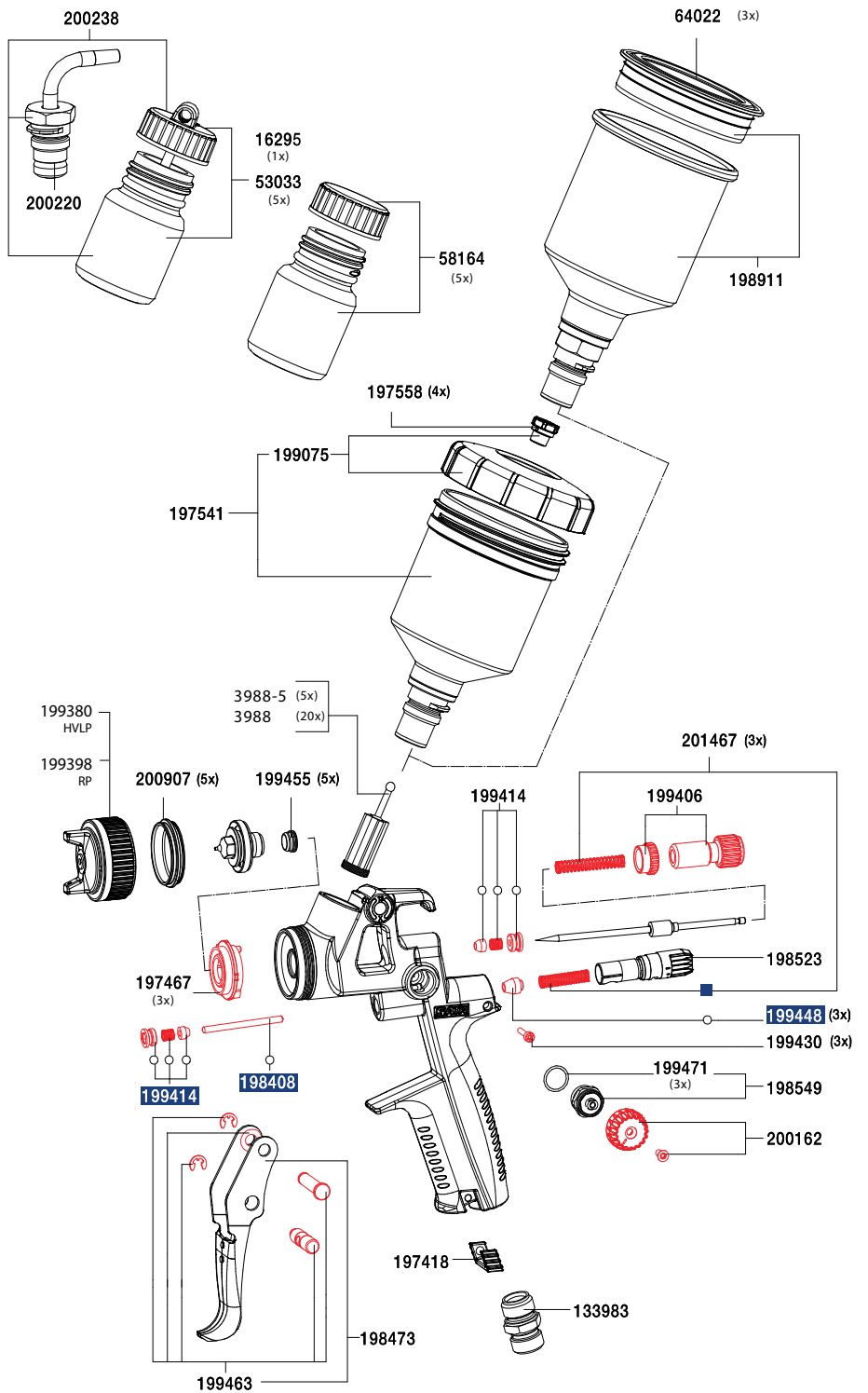

Art. No./Descr.
198572
Tool kit
· Universal spanner
· Cleaning brush
· 198598 Combi tool
· Paint strainer
· Extraction tool
· CCS-Clip Kit

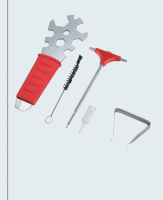

Art. No./Descr.
198614
Repair kit
199422
Air piston service unit
○ 200246
Sealing kit

Technical modifications and printing errors reserved



SATAjet® 3000 K RP®/HVL

Use for high quality topcoat finishes in automotive, fleet or any industrial application. The SATAjet® 3000 K™ HVL offers the finest atomization and a top-class finish and achieved by SATA® technology, ensures transfer efficiencies considerably above 65 % required by VOC legislation. The patented air circulation principle provides an especially homogeneous and soft fan. The large fan and high material flow rates ensure swift work. Excellent ergonomics - the short gun body, extremely low weight and the optimum balance ensure the gun "fits like a glove". Suitable for water-borne materials - paint needle and nozzle are made of stainless steel, and the nickel-plated gun body has been refined with a special coating. The durable air caps are made of brass (not of aluminium), therefore ensuring a long life time - a factor particularly important for industrial use.

SATAjet 3000 K RP

Technical Data	Inlet pressure: 6-43 psi
	Air consumption: 15.2 cfm at 36 psi
	Spray distance: 6 - 9 in
	Material connection: G 3/8 male thread



Nozzle	0.8	1.1	1.3	1.5	1.7	2.0
---------------	-----	-----	-----	-----	-----	-----

Standard gun Standard (STD) or Specially Treated (ST) Nozzle

Order No. STD	92932	93336	93344	93351	93369	93377	
Order No. ST	163022	141994	142265	166421	93369ST	-	

Standard gun with DIGITAL SATAadam 2, Standard (STD) or Specially Treated (ST) Nozzle

Order No. STD	92692	93120	93138	93146	93161	93179	
Order No. ST	92692ST	137869	137877	93146ST	93161ST	93179ST	
Nozzle	0.8	1.1	1.3	1.5	1.7	2.0	

Nozzle Set - Standard (STD) or Specially Treated (ST)

Order No. STD	92494	92502	92510	92528	95422	95356	
Order No. ST	141317	137901	137919	137927	137935	137943	

available upon request

Spray guns and nozzle sets with lifetime prolonging surface of fluid tip and paint needle.

SATAjet 3000 K HVL

Technical Data	Inlet pressure: 36 psi
	Air consumption: 18.7 cfm at 36 psi
	Spray distance: 5 - 8 1/2 in
	Material connection: G 3/8 male thread



Nozzle	0.8	1.0	1.2	1.4	1.6	2.0
---------------	-----	-----	-----	-----	-----	-----

Standard gun with Standard (STD) or Specially Treated (ST) Nozzle

Order No. STD	93385	92924	93393	193656	96164	96172	
Order No. ST	93385ST	92924ST	93393ST	CALL	137851	96172ST	

Standard gun with DIGITAL SATA adam 2, Standard (STD) or Special Treated (ST) Nozzle

Order No. STD	93286	92718	93294	CALL	96149	96156	
Order No. ST	93286ST	92718ST	93294ST	CALL	96149ST	96156ST	

Test Air Cap	95059			95067			
Nozzle	0.8	1.0	1.2	1.4	1.6	2.0	

Nozzle Set - Standard (STD) or Specially Treated (ST)

Order No. STD	92783	92791	92809	191379	92817	92825	STD = Standard
Order No. ST	147058	137950	137968	CALL	137976	137984	ST = Special Treated
Test Air Cap	95059	95059	95067	95067	95067	95067	

available upon request

Spray guns and nozzle sets with lifetime prolonging surface of fluid tip and paint needle.

Technical modifications and printing errors reserved

Spare Parts SATAjet® 3000 K

Order No./Desc.	
240	Air piston packing
1503	Fan control screw
3426	Circlip only, 1 each
3624	Pin, micrometer
3699	Pin, lower trigger
6981	Female nipple, pk of 5
7757	Color Code disc, pk of 4
10033	Air cap ring w/seal, 3000 K RP
12591	Pin, upper trigger
13656	Female nipple (German)
14605	Bushing, needle packing
14985	Battery kit, digital
14993	Spring, needle packing
15438	Needle packing service set
17525	Lock spring
17897	Needle spring
23275	Needle packing
38265	Material filter, R 3/8
38638	Air ring, K3000 K, HVLP and RP
38638-3	Air ring, pk of 3
38638-5	Air ring, pk of 5
38638-20	Air ring, pk of 20
43638	Wire tool, air ring
50542	Lock nut fluid control
53470	Trigger slider pad
53603	Air micrometer
82636	Air piston packing holder
91108	QC nipple
91140	QC w/nipple
91157	QC w/filter and nipple
91835	Knob, fan control
91884	Trigger
91959	Air piston, 3000 K
92031	Paint pipe, 3000 K, R 3/8
92049	Fan control
92056	Trigger service set
92577	Tool set, 3000 K
92619	Fluid control service set
92742	Fan control service set
92759	Air piston service set
92767	Repair kit, 3000 K HVLP & RP
93732	Air cap ring w/seal, 3000 K HVLP
95091	Air inlet fitting, Digital 
133926	Kit, trigger sleeve
133942	Air piston packing
133959	Kit, spring, pk of 3 each of #215806 & #17897
133967	Pin, air micrometer, pk of 3
133991	Packing, air piston, pk of 3
134098	Air inlet fitting, 1/4" BSP
143834	Seal, air cap ring, pk of 5
183780	Seal kit
215806	Spring, air piston

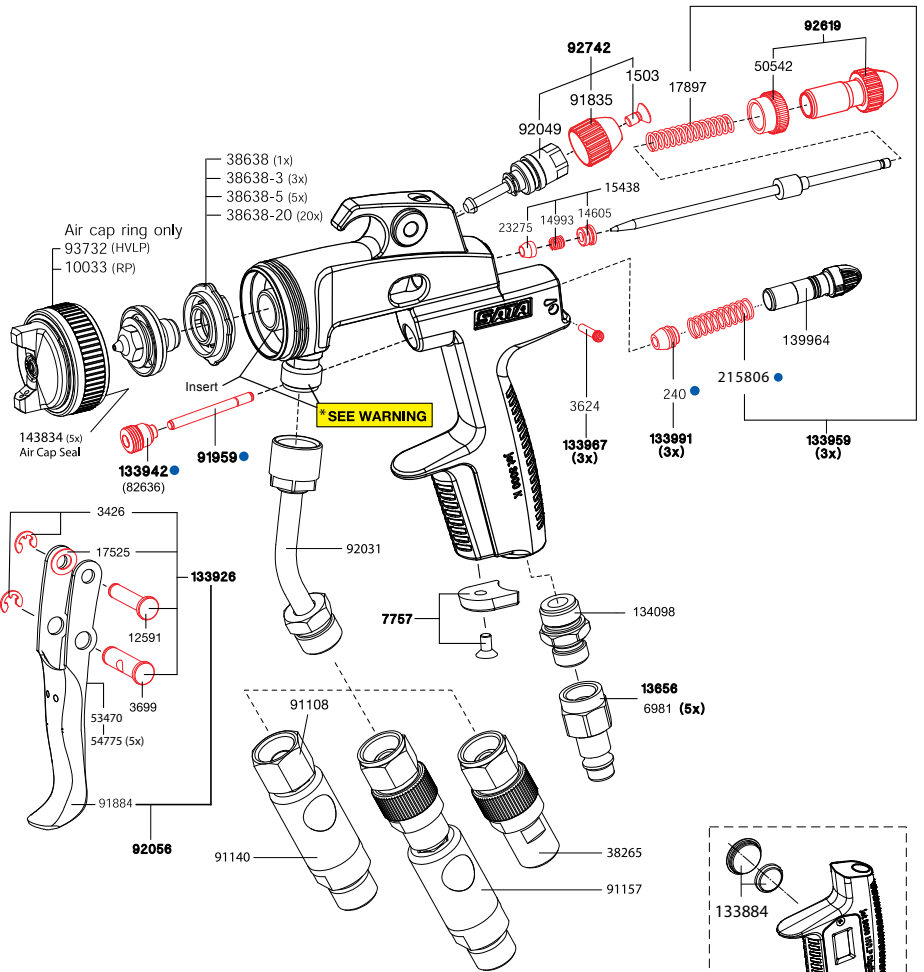

Do not remove the insert, seal, and fluid inlet. Special tools are required.

CALL SATA repair department for details.

WARNING
 on DIGITAL GUNS
 Replacing part number 95091 or removing the DIGITAL display cover **IS NOT RECOMMENDED**
VOIDS WARRANTY
 It must be returned for service otherwise it will not function properly

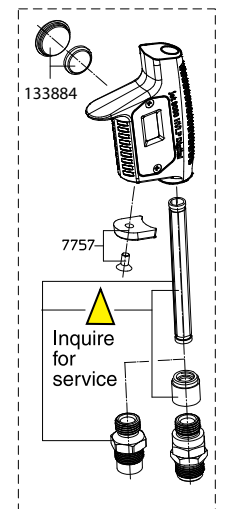

DIGITAL function is no longer in production. Parts are available. Call if servicing digital parts.

92577 Tool Kit	
901	Universal spanner wrench
3509	Cleaning brush
64543	Allen wrench 2mm
9647	Allen wrench 4mm Torx wrench
43638	Extraction tool
	Paint sieve

Order No./Desc.
92767
Repair kit
92759
Air piston service set

Technical modifications and printing errors reserved

SATAjet® 3000 K spray mix

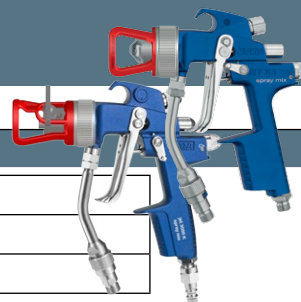

SATAjet 3000 K spray mix

Technical Data

Max. operating pressure atomization air: 145 psi
Max. operating pressure material: 3,625 psi
Weight incl. material filter: 23 oz.

Spray mix gun

120006	SATAjet 3000 K spray with paint pipe, strainer 100 mesh, and nozzle set (specify material nozzle size)
--------	--

Spray mix gun w/ Reversing switch

120014	SATAjet 3000 K spray with paint pipe, strainer 100 mesh, and reversing nozzle (specify reversing nozzle size)
--------	---

207530	Reversing switch kit for SATAjet 3000 K spray mix w/out reversing nozzle
--------	--

Using a reversing nozzle requires a "one time" purchase of the reversing switch. Part Number 207530

Nozzles - SATAjet 3000 K spray mix

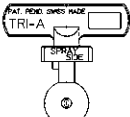
Fluid tip		Reversing nozzle for reversing switch		Technical Data									
				Nozzle No.	Order No.	Nozzle No.	Order No.	ø mm	ø inch	Angle	Width In.	oz/min @ 1015 psi	Strainer
1840	23044*			0.18	0.007	40°	7	5.41					
2325	7328			0.23	0.009	25°	6	7.78					
2350	7435			0,23	0.009	50°	9	7.78					
2360	74922			0.23	0.009	60°	10	7.78					
		2550	207548	0.25	0.010	20°/50°	4/9	8.45				200 msh 85 µm	74856 4 per set
2825	16998			0.28	0.011	25°	6	10.14					
2850	50906			0.28	0.011	50°	9	10.14					
2865	13771			0.28	0,011	65°	10	10.14					
		3050	207555	0.30	0.012	20°/50°	4/9	12.85					
3325	20206			0.33	0.013	25°	6	15.22					
3350	50898			0,33	0.013	50°	9	15.22					
3365	13789			0.33	0.013	65°	11	15.22					
3375	74930			0.33	0.013	75°	13	15.22					
3390	73742			0.33	0.013	90°	16	15.22					
		3550	207563	0,35	0,014	20°/50°	4/9	17				100 msh 150 µm	12278 4 per set
3825	13797			0,38	0,015	25°	6	20.63					
3850	7344			0,38	0,015	50°	10	20.63					
3882	74948			0,38	0,015	82°	14	20.63					
		4050	207571	0,40	0,016	20°/50°	4/9	23.6					
4650	19307			0,46	0,018	50°	9	32					
4682	74955			0,46	0,018	82°	14	32				60 msh 250 µm	12260 4 per set
5370	150276			0,53	0,021	70°	13	42					
6050	17004			0,60	0,024	50°	12	53.76					

Nozzle Inversion + Retrofit Kit

214619	Kit inversion nozzle 2550 + retrofit kit	Includes 207530 & 207548
214627	Kit inversion nozzle 3050 + retrofit kit	Includes 207530 & 207555
214635	Kit inversion nozzle 3550 + retrofit kit	Includes 207530 & 207563
214643	Kit inversion nozzle 4050 + retrofit kit	Includes 207530 & 207571

Hose pairs see page 167

Further accessories, material and air connections see pages 30-32

Spare Parts SATAjet® 3000 K spray mix

Order No./Desc.	
240	Air piston packing
1503	Fan control screw
3426	Circlip, pin
3624	Pin, micrometer
3699	Pin, lower trigger
12260	Sieve, 60 msh, pkg of 4
12278	Sieve, 100 msh, pkg of 4
12591	Pin, upper trigger
17525	Washer, tension spring
18341	Needle spring
30833	Nozzle cleaning kit
38638	Air distrib. ring, spray mix
*38638-3	Air ring, pk of 3
*38638-5	Air ring, pk of 5
*38638-20	Air ring, pk of 20
53603	Air micrometer
74856	Sieve, 200 msh, pkg of 4
82636	Air piston packing holder
91835	Knob
91959	Air piston, K3
92759	Air piston service set
98434	Pre-nozzle
98442	Seal ring, pre-nozzle
98459	Air cap, round/flat
98525	Packing holder
98541	Needle tip
98608	Paint pipe, ?, w/100 msh filter
98624	Fan control
98681	Trigger service set
98699	Tool kit, Sp. Mix
98707	Repair kit, Sp. Mix
98764	Pre-nozzle w/needle tip
98772	Needle w/needle tip
98806	Fan control service set
120071	Trigger lock, complete
207522	Seal, reversing nozzle
207530	Reversing switch
215806	Spring, air piston
228056	Air cap ring with protection against accidental contact
228049	Air cap ring with protection against accidental contact

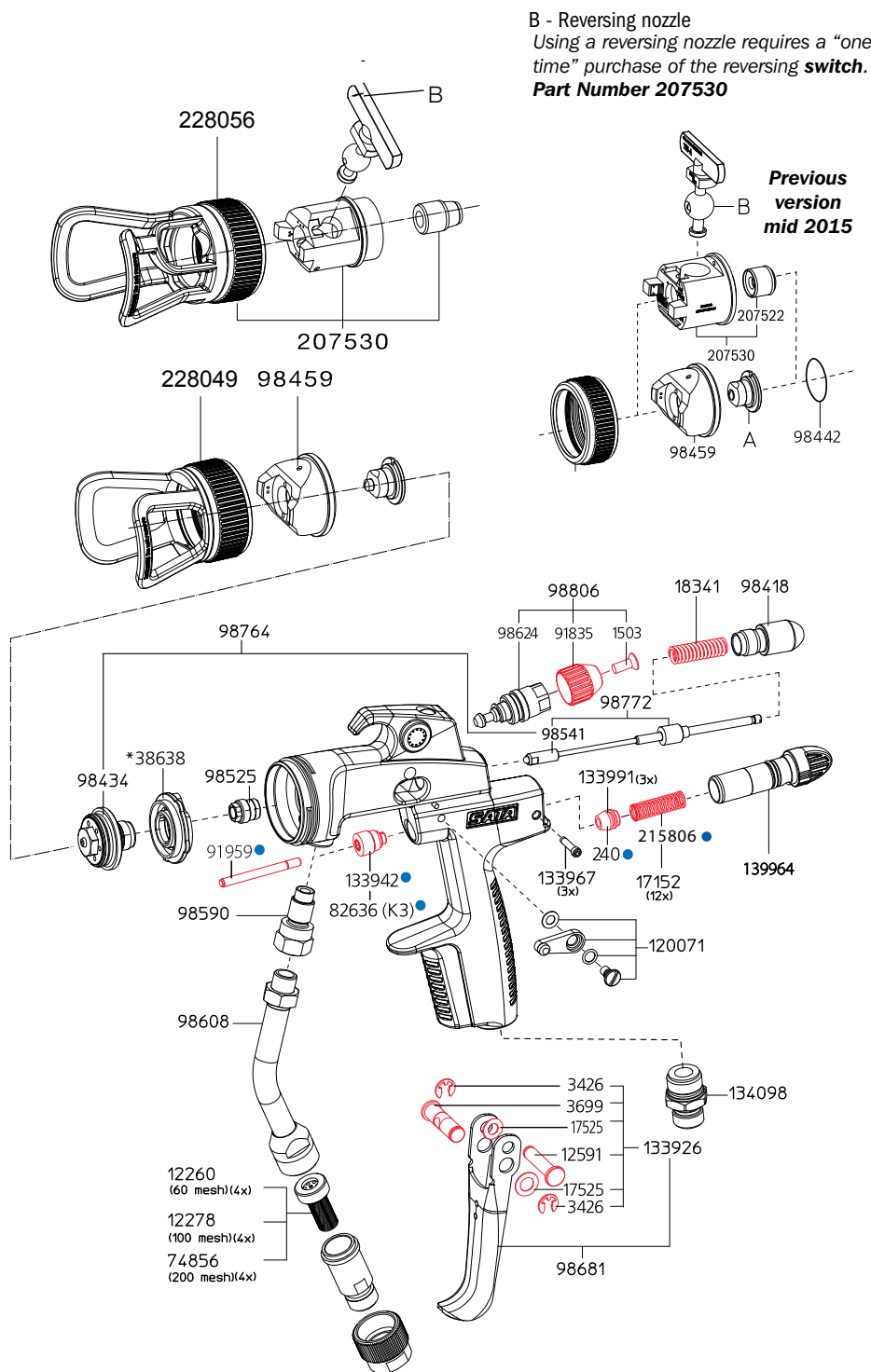

Technical modifications and printing errors reserved

98699 Tool Kit	
901	Universal spanner wrench
9647	Allen wrench 4mm
15925	Wrench
43638	Extraction tool
64543	Allen wrench 2mm
76307	Socket set

Do not remove the insert, seal, and fluid inlet. Special tools are required.

CALL SATA repair department for details.

Order No./Desc.
98707
Repair kit
○ 92759
Air piston service set
○ 30833
Nozzle cleaning kit



SATAjet® 1000 B RP®/HVL

SATAjet 1000 B RP

Technical Data	Inlet pressure: 21-29 psi
	Air consumption: 7.1 cfm at 36 psi
	Spray distance: 6 1/2 - 8 1/4 in
	Weight: 15 oz.
	Finish: Smooth anodized



Nozzle	0.8	1.0	1.3	1.6	1.8	2.0	2.5	3.0	4.0	5.0
---------------	-----	-----	-----	-----	-----	-----	-----	-----	-----	-----

Spray gun with QCC 0.6 PVC cup											
Order No.	151183	151191	149302	149310	150391	149328	151209	151217	154161	Call	
Spray gun with QCC 0.75 aluminum cup											
Order No.	151225	151233	150342	149344	150409	149351	151241	151258	154179	Call	
Spray gun with QCC 1.0 aluminum cup											
Order No.	-	158071	158089	158097	158105	158113	158121	158139	Call	Call	
Nozzle	0.8	1.0	1.3	1.6	1.8	2.0	2.5	3.0	4.0	5.0	
Nozzle Set											
Order No.	151316	151324	149161	149179	150417	149187	151332	151340	154187	154195	
	High Viscosity						222372	222380			

RP nozzle extensions available

SATAjet 1000 RP B D (drill)

Modified nozzle set for special glue applications, in particular water-dispersion adhesives. Not suitable for paint application

Nozzle	1.6 D
Order No.	164962
Nozzle Set	164970

SATAjet 1000 B HVL

Technical Data	Inlet pressure: 2.0 bar / 29 psi
	Air consumption: 2.0 bar 350 NI/min / 12.5 cfm at 36 psi
	Spray distance: 13-17 cm / 5 - 9 1/2 in
	Weight: 15 oz.
	Finish: Smooth anodized



Nozzle	1.4	1.7	1.9	2.1
---------------	-----	-----	-----	-----

Spray gun with QCC 0.6 PVC cup				
Order No.	149377	149385	149393	149401
Spray gun with QCC 0.75 aluminum cup				
Order No.	149419	149427	149435	149443
Spray gun with QCC 1.0 aluminum cup				
Order No.	158147	158154	Call	Call
Test Air Cap	157222			
Nozzle	1.4	1.7	1.9	2.1
Nozzle Set				
Order No.	149195	149203	149211	149229

Technical modifications and printing errors reserved

Spare Parts SATAjet® 1000 B

Order No./Desc.	
240	Seal, air piston
901	Wrench, universal spanner
1503	Screw, fan control
3426	Circlip, pin
3509	Brush, large standard
3624	Pin, air micrometer
3699	Pin, lower trigger
3988	Sieve, pk of 20
3988-5	Sieve, pk of 5
6395	Disc, CC (standard), pk of 4
9050	Tool set
9647	Allen wrench, 4
12591	Pin, upper trigger
14605	Bushing, needle
14993	Spring, needle bushing
15438	Kit, needle packing
17525	Washer, tension spring
17897	Spring, needle
23275	Seal, needle
215806	Spring, air piston
64543	Allen wrench, 2
69872	O-ring, fan control
82826	Kit, air piston service set
89771	Control, RH w/O-ring
91959	Air piston
92577	Tool set
96875	Seal, inner cup
160853	Air micrometer, DIGITAL Adam II
130393	Seal, air cap ring
130435	Air cap ring only (RP)
130443	Air cap ring only (HVLP)
130492	Trigger kit
130542	Repair kit, Jet 1000 K
133926	Kit, trigger sleeve
133934	O-ring, fan control, pk of 3
133942	Bushing, air piston
133959	Spring kit, 3 each of #215806 & #17897
133967	Pin, air micrometer, pk of 3
133983	Fitting, air inlet, R ?
133991	Seal, air piston, pk of 3
134031	Knob, fan control w/screw, 2 pk
139188	Kit, fluid control and lock nut
139964	Air micrometer, standard
140574	Knob, fan control w/screw
140582	Seal, fluid tip, pk of 5
143230	Air distribution ring, pk of 3
183780	Seal kit

Air cap ring only
130443 (1000 HVLP)
130435 (1000 RP)

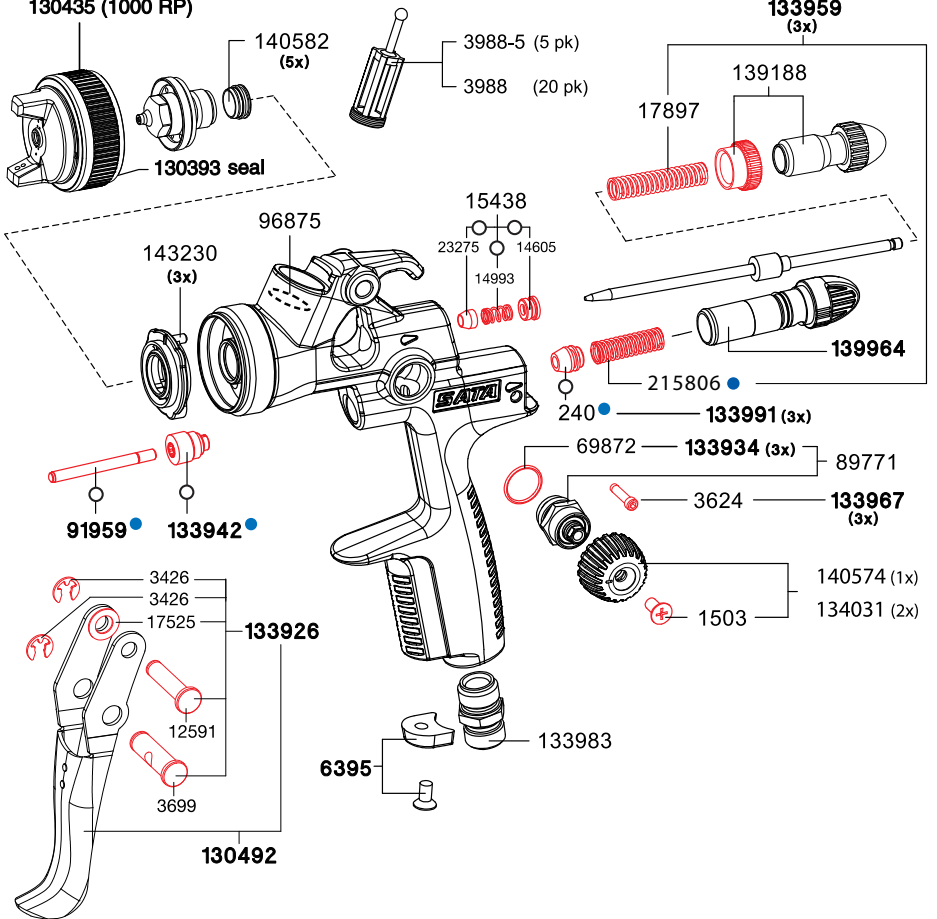

9050 Tool Kit

901	Universal spanner wrench
3509	Cleaning brush
9647	Allen/Torx wrench
64543	Allen wrench
43638	Extraction tool

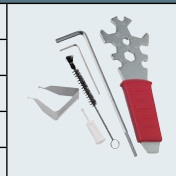

Order No./Desc.

130542	Repair kit
92759	Air piston service set
183780	Sealing Kit

Technical modifications and printing errors reserved



SATAjet® 1000 K RP®/HVLV



SATAjet 1000 K RP

Technical Data	Inlet pressure: 36 psi										
	Air consumption: 14.5 cfm at 36 psi										
	Spray distance: 7 - 9 in										
	Material connection: G 3/8 exterior thread										

Nozzle	0.8	1.1	1.3	1.5	1.7	2.0	2.5	3.0	4.0	5.0
---------------	-----	-----	-----	-----	-----	-----	-----	-----	-----	-----

Standard gun with Standard (STD) or Specially Treated (ST) Nozzle

Order No. STD	132092	132100	132118	132126	132134	132142	153486	153494	154336	-	
Order No. ST	141903	141911	141929	141937	141945	141952	-	-	-	-	

Nozzle	0.8	1.1	1.3	1.5	1.7	2.0	2.5	3.0	4.0	5.0
---------------	-----	-----	-----	-----	-----	-----	-----	-----	-----	-----

Nozzle Set

Order No. STD	132159	132167	132175	132183	132191	132209	153528	153536	154377	154385	
Order No. ST	141648	141655	141663	141689	141697	141705	159442	-	-	-	

SATAjet 1000 RP for adhesive applications

161232	SATAjet 1000 K RP nozzle 1.6 D Drall material connection 3/8" (male thread)
159707	Nozzle set SATAjet 1000 K RP 1.6 Drall
211979	SATAjet 1000 K RP nozzle 1.3 DA for dispersion adhesives, material connection 3/8" (male thread)
211961	Nozzle set SATAjet 1000 K RP 1.3 DA for dispersion adhesives

SATAjet 1000 K HVLV

Technical Data	Inlet pressure: 36 psi					
	Air consumption: 18.7 cfm at 36 psi					
	Spray distance: 5 - 8 in					
	Material connection: G 3/8 exterior thread					

Nozzle	0.8	1.0	1.2	1.4	1.6	2.0
---------------	-----	-----	-----	-----	-----	-----

Standard gun with Standard (STD) or Specially Treated (ST) Nozzle

Order No. STD	139196	139204	139212	193664	139220	139238	
Order No. ST	141960	141978	141986	call	142000	142018	ST = Special treated nozzle resistant to abrasive material



Test Air Cap	143891	143909		
---------------------	--------	--------	--	--

Nozzle	0.8	1.0	1.2	1.4	1.6	2.0
---------------	-----	-----	-----	-----	-----	-----

Nozzle Set



Order No. STD	139253	139261	139279	191387	139287	139295	
Order No. ST	141762	141770	141804	Call	141812	141838	

Accessories for SATA pressure fed spray guns

92031	Paint pipe for SATA pressure fed spray guns G3/8i - G3/8a version for waterborne materials	
38265	Strainer for SATA pressure fed spray guns G3/8i - G3/8a, 60 mesh, WA version	

Technical modifications and printing errors reserved

Spare Parts SATAjet® 1000 K

Order No./Desc.	
240	Seal, air piston
901	Wrench, universal spanner
1503	Screw, fan control
3426	Circlip, pin
3509	Brush, large standard
3624	Pin, air micrometer
3699	Pin, lower trigger
6395	Disc, CC (standard), pk of 4
9647	Allen wrench, 4
12591	Pin, upper trigger
14605	Bushing, needle
14993	Spring, needle bushing
15438	Kit, needle packing
17525	Washer, tension spring
17897	Spring, needle
23275	Seal, needle
38265	Material filter, R 3/8
64543	Allen wrench, 2
69872	O-ring, fan control
82826	Kit, air piston service set
89771	Control, RH w/O-ring
91108	QC nipple only
91140	QC w/nipple
91157	QC w/filter and nipple
91959	Air piston
92031	Paint pipe, R 3/8
92577	Tool set
93526	Material connection 
130393	Seal, air cap ring
130435	Air cap ring only (RP)
130443	Air cap ring only (HVLP)
130484	Insert w/needle packing kit 
130492	Kit, trigger
130534	Ring, air distribution, pk of 3
130534-1	Ring, air distribution, each
130542	Kit, Repair, Jet 1000 K
133926	Kit, trigger sleeve
133934	O-ring, fan control, pk of 3
133942	Bushing, air piston
133959	Kit, spring, 3 each of #215806 & #17897
133967	Pin, air micrometer, pk of 3
133983	Fitting, air inlet, R ?
133991	Seal, air piston, pk of 3
139188	Kit, fluid control and lock nut
139964	Air micrometer, standard
140574	Knob, fan control w/screw
140582	Seal, fluid tip, pk of 5
143230	Air distribution ring (3 pk)
215806	Spring, air piston

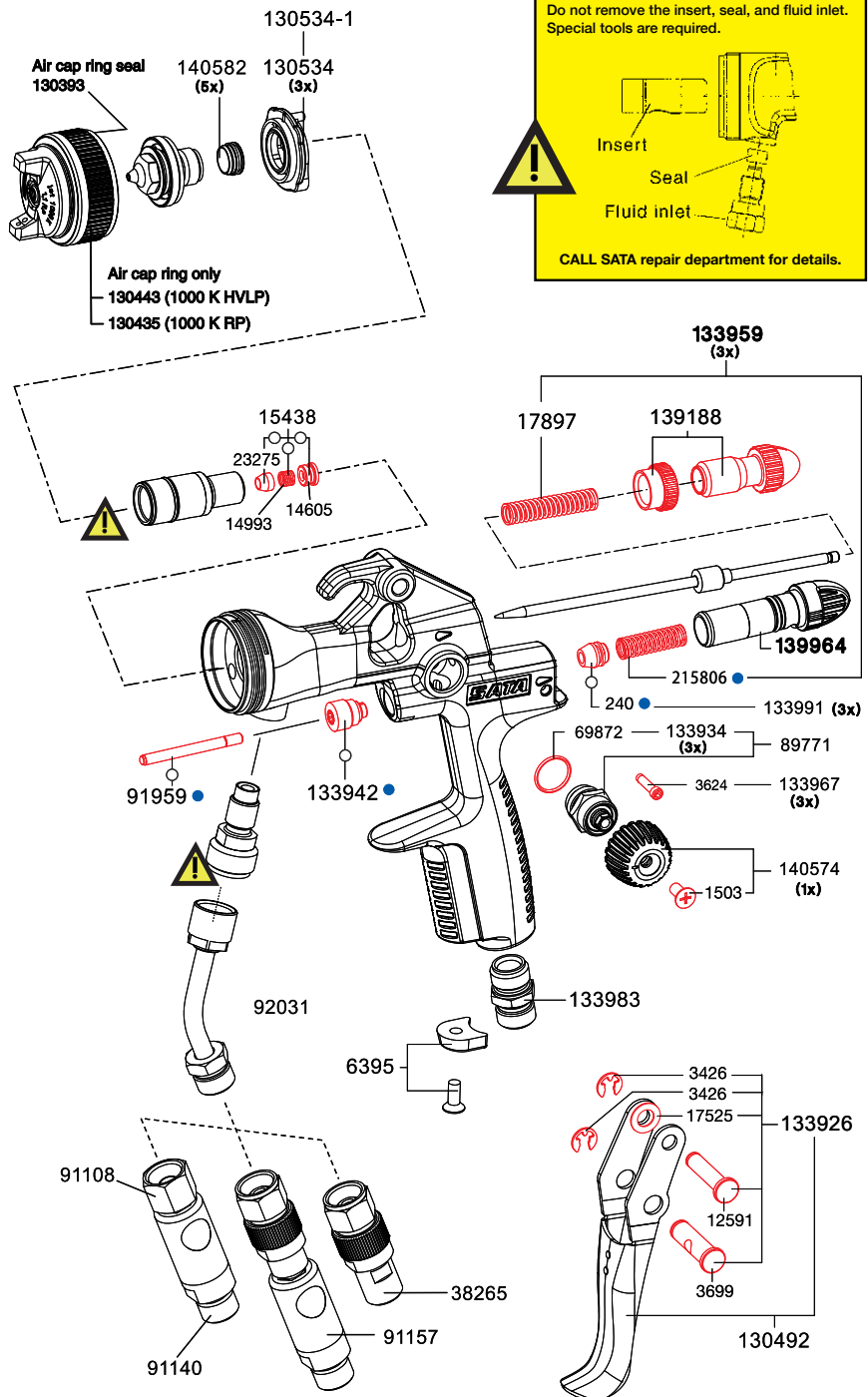

92577 Tool Kit	
901	Universal spanner wrench
3509	Cleaning brush
9647	Internal hex wrench
64543	Allen wrench
43638	Extraction tool

Order No./Desc.
130542
Repair kit
92759
Air piston service set
183780
Sealing Kit

Technical modifications and printing errors reserved

SATAjet® 1000 K Specialty Spray Guns

SATAjet 1000 K RP D

The SATAjet 1000 K is available in a special version for the application of glues/adhesives with round fan. This nozzle set has a nozzle size of 1.6. Available with or without fan control



Technical Data

Inlet pressure: 29 psi
 Air consumption: 9.7 cfm at 29 psi
 Spray distance: 7 - 9 in

Nozzle 1.6 D

Standard with round fan pattern D = Twist

Order No. 161232

Standard Round fan pattern, without air micrometer

Order No. 158535

Nozzle 1.6 D

Nozzle Set

Order No. 159707

SATAjet 1000 K RP DA (dispersion adhesives)

Modified nozzle version SATAjet 1000 K for the application of dispersion adhesives, optimized atomization of waterborne adhesives without overspray and settling of adhesives at the fluid tip



Nozzle 1.3

SATAjet 1000 K RP DA

Order No. 211979

Nozzle Set

Order No. 211961

SATAjet 1000 K Slit Nozzle

The SATAjet 1000 K RP slit nozzle is used for high viscosity material. In the construction trade it is used for spraying spatter for a textured finish.



Technical Data

Inlet pressure: 29 psi
 Air consumption: 9.7 cfm at 29 psi
 Spray distance: 7 - 9 in

Nozzle 25/55° 3.0/55° 4.0/79°

Standard

Order No. 154344 154351 154369

Nozzle 25/55° 3.0/55° 4.0/79°

Nozzle Set

Order No. 154393 154401 154419

SATAjet 1000 RP KK HKU Undercoating

Spray gun with round fan nozzle for the SATA HKU barrel pump system. Air connection 1/4" thread. Supplied complete with Type 1 #8359 material quick coupling for wands (material pipe not included, order separate)



Technical Data

Inlet pressure: 29 psi
 Air consumption: 14.5 cfm at 36 psi



Nozzle 1.5

Standard

Order No. 153700

Technical modifications and printing errors reserved

Parts SATAjet 1000 KK

Order No./Desc.	
240	Seal, air piston
901	Wrench, universal spanner
3426	Circlip, pin
3509	Brush, large standard
3624	Pin, air micrometer
3699	Pin, lower trigger
6395	Disc, CC (standard), pk of 4
8359	Wand coupling, small, Type I
9647	Allen wrench, 4
12591	Pin, upper trigger
14605	Bushing, needle
14993	Spring, needle bushing
15438	Kit, needle packing
17525	Spring, spacer lock
17897	Spring, needle
23275	Seal, needle
25486	Round spray nozzle, Type I
25874	O Ring, 9 x 1.5, end cap
31336	Paint pipe, R 3/8 to 1/4 air hose
64543	Allen wrench, 2
78154	End plug
82826	Kit, air piston service set
91959	Air piston
92577	Tool set
93526	Material connection 
130393	Seal, air cap ring
130435	Air cap ring only (RP)
130484	Insert w/needle packing kit 
130492	Kit, trigger
130534	Ring, air distribution, pk of 3
1305341	Ring, air distribution, each
130542	Kit, Repair, Jet 1000 K
133926	Kit, trigger sleeve
133942	Bushing, air piston
133959	Kit, spring, 3 each of #215806 & #17897
133967	Pin, air micrometer, pk of 3
133983	Fitting, air inlet, R ?
133991	Seal, air piston, pk of 3
139188	Kit, fluid control and lock nut
140582	Seal, fluid tip, pk of 5
143230	Air distribution ring (3 pk)
153718	Mixing nozzle
215806	Spring, air piston

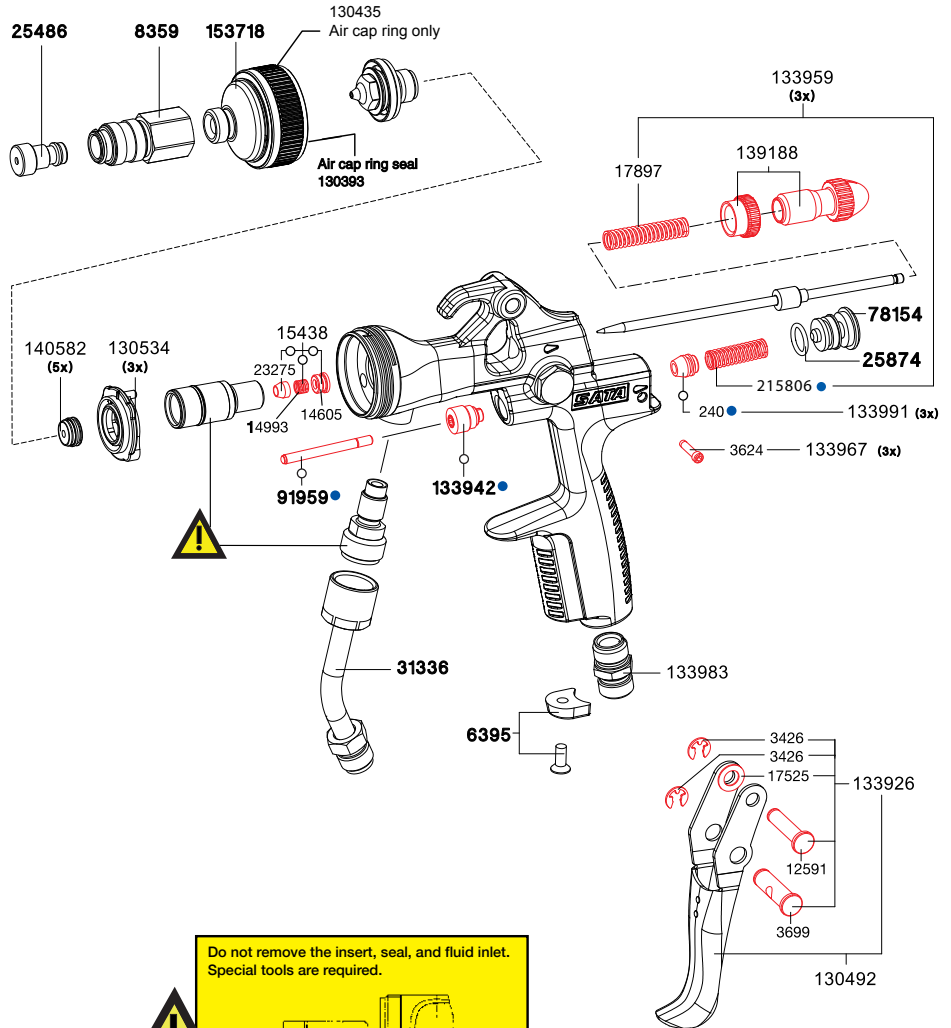



 Do not remove the insert, seal, and fluid inlet. Special tools are required.

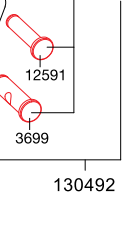

CALL SATA repair department for details.

92577 Tool Kit	
901	Universal spanner wrench
3509	Cleaning brush
9647	Internal hex wrench
64543	Allen wrench
43638	Extraction tool



Order No./Desc.
130542
Repair kit
 92759
Air piston service set
 183780
Sealing Kit

Technical modifications and printing errors reserved

SATAjet® 1000 H RP®





SATAjet 1000 H RP					
Technical Data		Inlet pressure: 29 psi			
		Air consumption: 9.7 cfm at 29 psi			
		Spray distance: 7 - 9 in			
Nozzle	1.3	1.6	1.8	2.0	
Standard with 1.0 l aluminum siphon cup					
Order No.	161034	151266	151274	153353	
Nozzle	1.3	1.6	1.8	2.0	
Nozzle Set					
Order No.	161059	151613	151621	153379	
Standard with no nozzle set					
Without nozzle set	Order no.	154930			

Accessories for SATAjet H		
188292	RPS Adapter No. 16 with QCC Connection thread G 3/8 To use for RPS siphon cup.	
188482	RPS Siphon Kit, pins, suction hose, sieve, (for 0.3L cup),pack of 25	
188516	RPS Siphon Kit, pins, suction hose, sieve, (for 0.3L cup), pack of 50	
188490	RPS Siphon Kit, pins, suction hose, sieve, (for 0.6L cup), pack of 25	
188524	RPS Siphon Kit, pins, suction hose, sieve, (for 0.6L cup), pack of 50	
188508	RPS Siphon Kit, pins, suction hose, sieve, (for 0.9L cup), pack of 25	
188532	RPS Siphon Kit, pins, suction hose, sieve, (for 0.9L cup), pack of 50	

RPS siphon cup system, "H" guns only

Spare Parts SATAjet® 1000 H

Order No./Desc.

240	Seal, air piston
1503	Screw, fan control
2691	Alum. suction cup
2733	Lid fitting, complete with seal ring
3426	Circlip, pin
3624	Pin, air micrometer
3699	Pin, lower trigger
6395	Disc, CC (standard), pk of 4
9050	Tool Kit
12591	Pin, upper trigger
14605	Bushing, needle
14993	Spring, needle bushing
15438	Kit, needle packing
17525	Spring, spacer lock
17897	Spring, needle
23275	Seal, needle
26120	1L Alum. suction cup wo/lid, w/rivets
38265	Material filter, R 3/8
45286	Non-drip device for suction cup, 4 pk
50195	Sieve for suction cup, 2 pk
51680	Gasket rings for suction cup, 4 pk
69872	O Ring, fan control
82826	Kit, air piston service set
89771	Control, RH w/O-Ring
91140	QC w/nipple
91157	QC w/filter and nipple
91959	Air piston
92031	Paint pipe, R 3/8
92577	Tool set
93526	Material connection 
130393	Seal, air cap ring
130435	Air cap ring only (RP)
130484	Insert w/needle packing kit 
130492	Kit, trigger
130534	Ring, air distribution, pk of 3
130534-1	Ring, air distribution, each
130542	Repair Kit, Jet 1000 K
133926	Kit, trigger sleeve
133934	O Ring, fan control, pk of 3
133942	Bushing, air piston
133959	Kit, spring, 3 ea. of #215806 & #17897
133967	Pin, air micrometer, pk of 3
133983	Fitting, air inlet, R ?
133991	Seal, air piston, pk of 3
139188	Kit, fluid control and lock nut
139964	Air micrometer, standard
140574	Knob, fan control w/screw
140582	Seal, fluid tip, pk of 5
183780	Sealing kit
215806	Spring, air piston

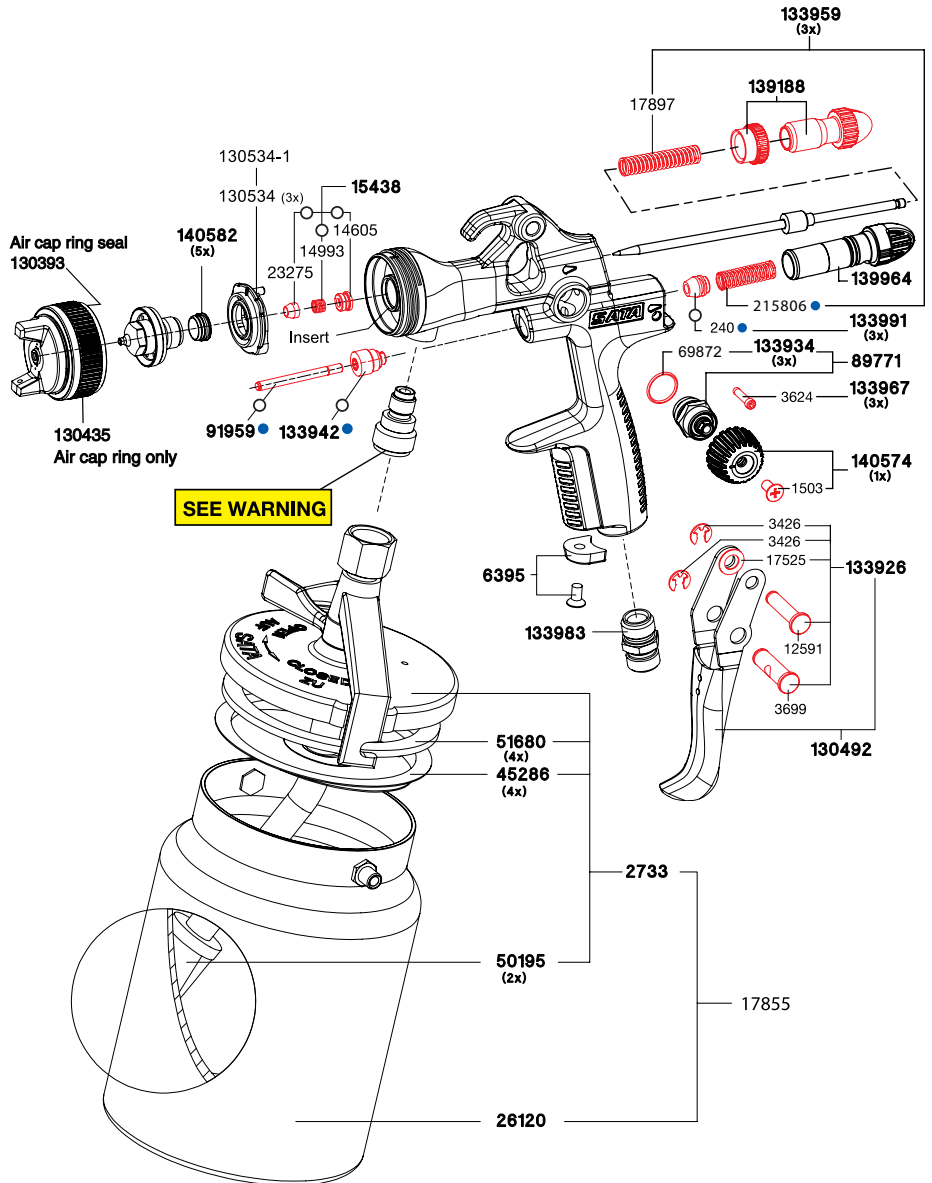

SEE WARNING

***WARNING**
Do not remove the insert, seal, and fluid inlet. Special tools are required.

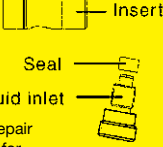

CALL SATA repair department for details.

Technical modifications and printing errors reserved

92577 Tool Kit

901	Universal spanner wrench
3509	Cleaning brush
9647	Internal hex wrench
64543	Allen wrench
43638	Extraction tool



Order No./Desc.

130542	Repair kit
92759	Air piston service set
183780	Sealing Kit

Material and air connection SATAjet® 3000 K, 1000 K

Order No./ Desc.
6981 Quick coupling nipple G 1/4 female thread, packing unit:5
13656 Quick coupling nipple G 1/4 female thread, hi-flow HVLV: 1
13623 SATA quick coupling 100.14 G 1/4 male thread
38265 Strainer for SATA pressure fed spray guns G3/8i - G3/8a. 60 mesh, WA-version
91140 Material coupling G 3/8 a for SATA pressure fed spray guns with plug-in nipple G3/8i
91157 Material coupling with plug-in nipple and material strainer 60 mesh, G3/8i - G3/8a for SATA pressure fed spray guns
92031 Paint pipe for SATA pressure fed spray guns G3/8i - G3/8a version for waterborne material

Spare sieves

Order No./ Desc.
12260 4-pk sieves, 60 mesh for SATA paint strainer
12278 4-pk sieves, 100 mesh for SATA paint strainer
74856 SATA strainer kit, consisting of 4 sieves 200 mesh, 2 strainer holders and 1 screw for SATA paint strainer

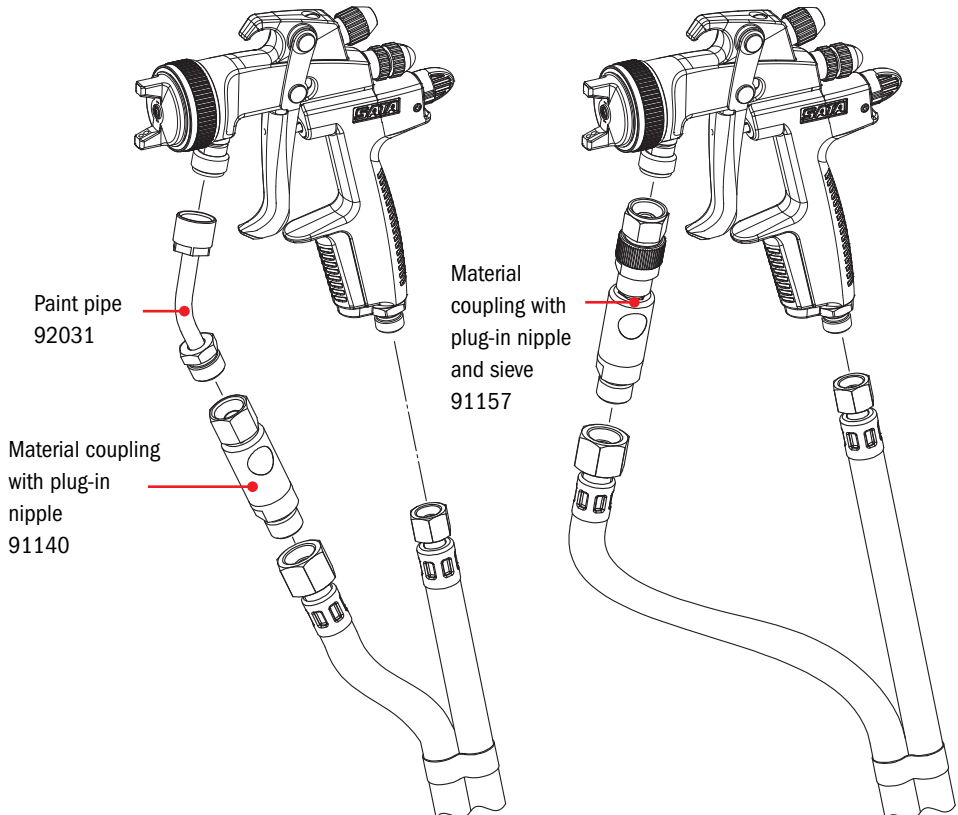
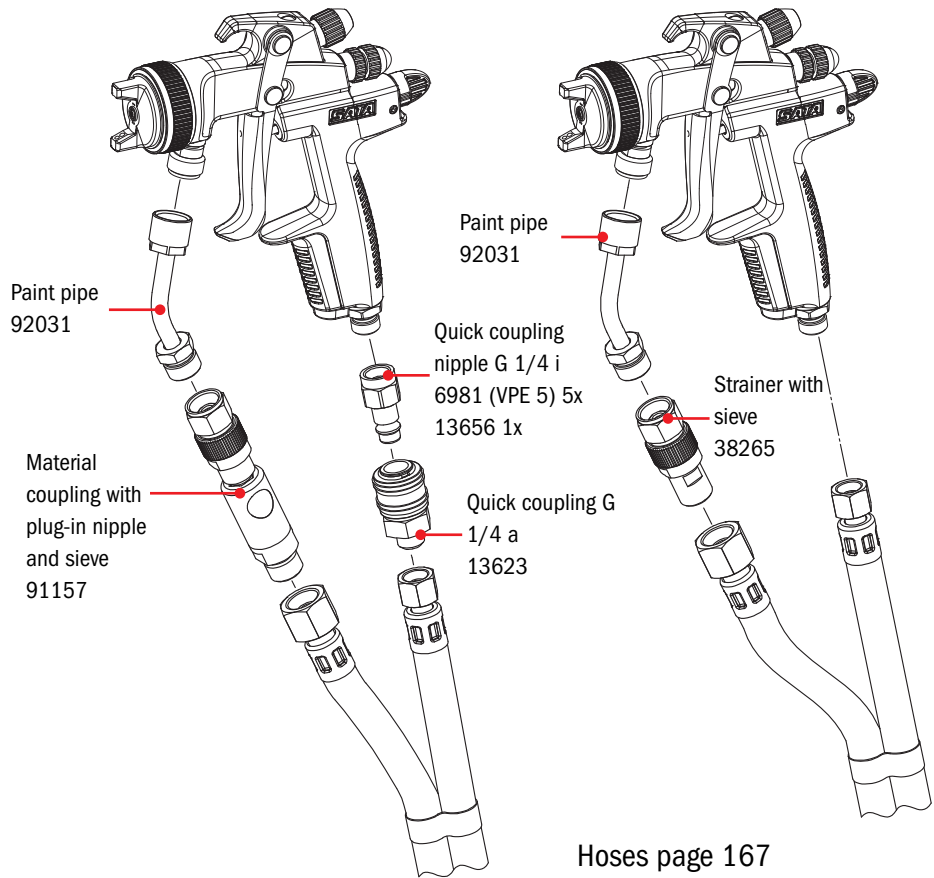

Technical modifications and printing errors reserved

Material and air connection SATAminijet® 1000 K

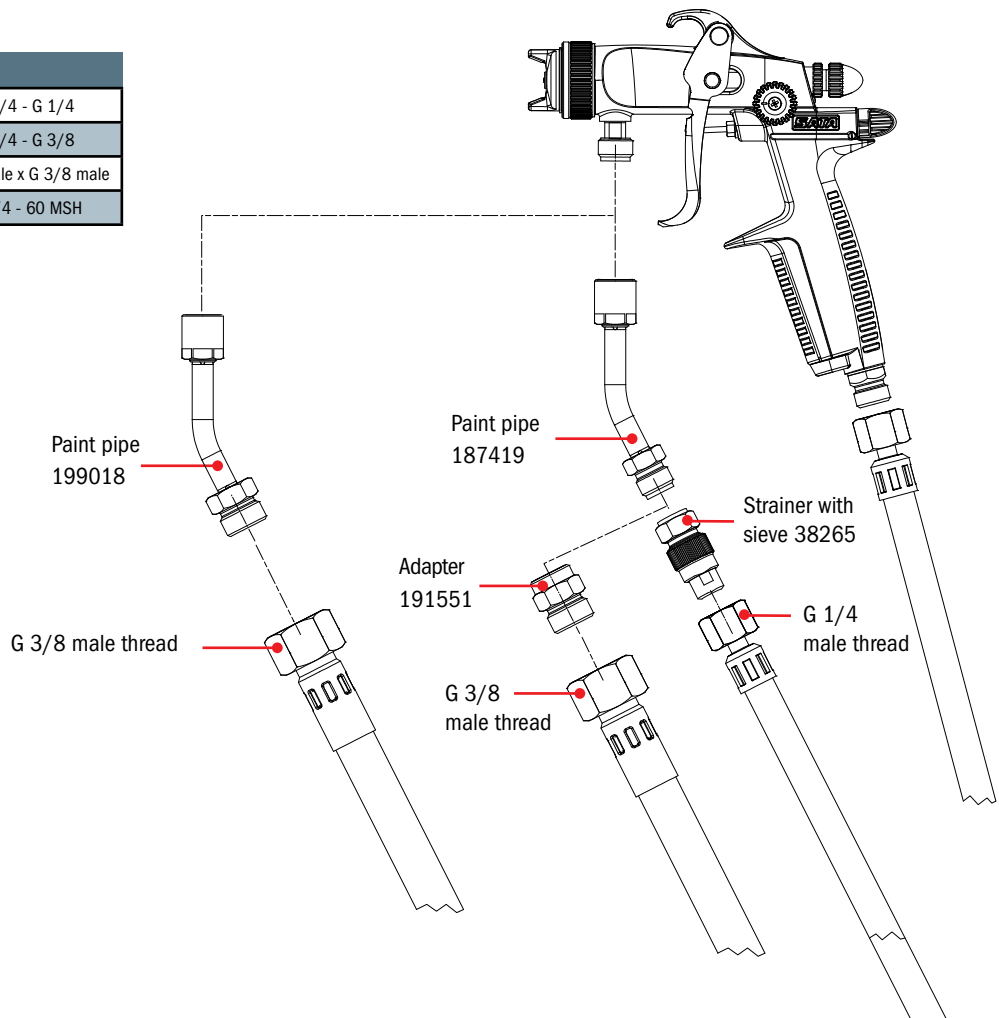

Order No./Desc.	
187419	Paint pipe, SS, G 1/4 - G 1/4
199018	Paint pipe, SS, G 1/4 - G 3/8
191551	Adapter, G 1/4 male x G 3/8 male
187690	Material filter, G 1/4 - 60 MSH



Hoses page 167

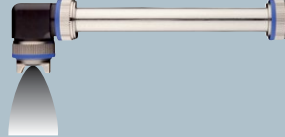

Accessories SATAjet® 1000 B/K

Extensions SATAjet 1000 K RP

154435	20 cm - Straight Extension SATAjet 1000 K RP 1.5 round/flat fan	
154443	30 cm - Straight Extension SATAjet 1000 K RP 1.5 round/flat fan	
154450	40 cm - Straight Extension SATAjet 1000 K RP 1.5 round/flat fan	
154476	20 cm - 45° Diagonal spray extension SATAjet 1000 K RP 1.6	
154484	30 cm - 45° Diagonal spray extension SATAjet 1000 K RP 1.6	
154492	40 cm - 45° Diagonal spray extension SATAjet 1000 K RP 1.6	
154518	20 cm - 360° Internal mixing extension SATAjet 1000 K RP 1.6	
154526	30 cm - 360° Internal mixing extension SATAjet 1000 K RP 1.6	
154534	40 cm - 360° Internal mixing extension SATAjet 1000 K RP 1.6	
154559	20 cm - 90° Angular head extension SATAjet 1000 K RP 1.6	
154567	30 cm - 90° Angular head extension SATAjet 1000 K RP 1.6	
154575	40 cm - 90° Angular head extension SATAjet 1000 K RP 1.6	



Extensions in other lengths are available upon request

Extensions SATAjet 1000 A RP







164293	20 cm - 45° Diagonal spray extension SATAjet 1000 K RP 1.6	
164301	30 cm - 45° Diagonal spray extension SATAjet 1000 K RP 1.6	
Call	40 cm - 45° Diagonal spray extension SATAjet 1000 K RP 1.6	
164277	20 cm - 360° Internal mixing extension SATAjet 1000 K RP 1.6	
164285	30 cm - 360° Internal mixing extension SATAjet 1000 K RP 1.6	
Call	40 cm - 360° Internal mixing extension SATAjet 1000 K RP 1.6	

Extensions in other lengths are available upon request

Accessories for SATA pressure fed spray guns

92031	Paint pipe for SATA pressure fed spray guns G3/8i - G3/8a version for waterborne materials	
187419	Paint pipe for SATA pressure fed spray guns 1/4" ID, 1/4" OD	
199018	Paint pipe for SATA pressure fed spray guns 1/4" x 3/8"	
38265	Strainer for SATA pressure fed spray guns G3/8i - G3/8a, 60 mesh, WA version	
187690	SATA material filter G 1/4 60 MSH	

Additional accessories for SATA pressure fed spray guns

12260	4-pk sieves, 60 mesh for SATA paint strainer	
12278	4-pk sieves, 100 mesh for SATA paint strainer	
74856	SATA strainer kit, consisting of 4 sieves 200 mesh, 2 strainer holders and 1 screw for SATA paint strainer	
91108	QC nipple	
91140	Material coupling G 3/8 a for SATA pressure fed spray guns with plug-in nipple G3/8i	
91157	Material coupling with plug-in nipple and material strainer 60 mesh, G3/8i - G3/8a for SATA pressure fed spray guns	

Technical modifications and printing errors reserved

Parts nozzle extensions

Components for SATAjet 1000 RP - Straight Nozzle Extension

SATAjet 1000 K Straight Nozzle Extension

Part No.	Description
140582	Seal, fluid tip, pk of 5
154914	Sealing ring

Ext. No.	Length	Pos 10	Pos 20	Pos 30	Pos 40	Pos 50
154435	20cm	154880	139071	139477	154716	154807
154443	30cm	154896	139071	139477	154724	154815
154450	40cm	154906	139071	139477	154732	154823

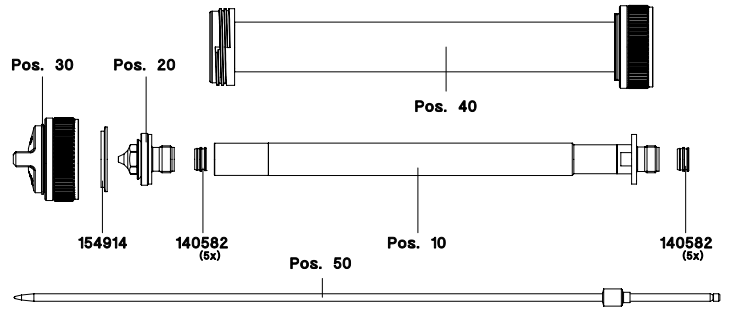

SATAjet 1000 K & A 45° Nozzle Extension

Part No.	Description
43760	Tightening ring
140582	Seal, fluid tip, pk of 5
155226	Flange sleeve

SATAjet 1000 K						
Ext. No.	Length	Pos 10	Pos 20	Pos 30	Pos 40	Pos 50
154476	20cm	155184	24158	24141	24182	155267
154484	30cm	155192	24158	24141	4432	155275
154492	40cm	155200	24158	24141	4531	155283

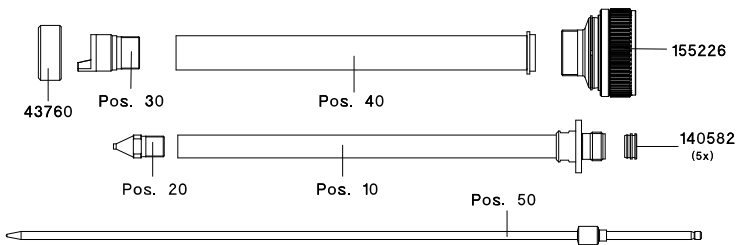

Automatic spray guns

Ext. No.	Length	Pos 10	Pos 20	Pos 30	Pos 40	Pos 50
164293	20cm	155184	24158	24141	24182	46490
164301	30cm	155192	24158	24141	4432	47100
	40cm	155200	24158	24141	4531	47688

SATAjet 1000 K 90° Nozzle Extension

Part No.	Description
30932	O-ring
140582	Seal, fluid tip, pk of 5
154955	Angular head
155099	Fluid tip 3.0

Ext. No.	Length	Pos 10	Pos 20	Pos 30	Pos 40	Pos 50
154559	20cm	155036	139071	139477	154971	155101
154567	30cm	155044	139071	139477	154989	155119
154575	40cm	155051	139071	139477	154997	155127

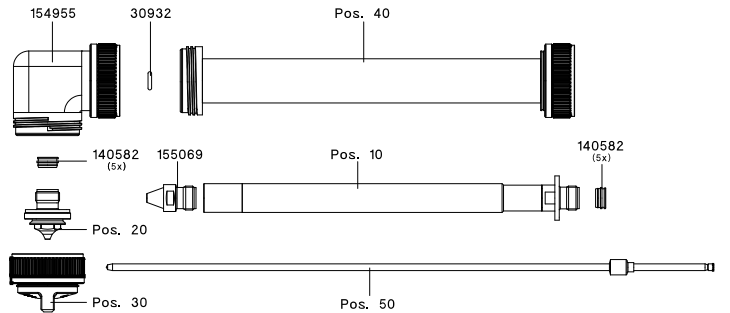

SATAjet 1000 K & A 360° Nozzle Extension

Part No.	Description
30585	Plate-shaped internal mixing nozzle
30593	Nozzle screw
43760	Tightening ring
140582	Seal, fluid tip, pk of 5
155226	Flange sleeve

SATAjet 1000 K						
Ext. No.	Length	Pos 10	Pos 20	Pos 40	Pos 50	
154518	20cm	155184	24158	24182	155267	
154526	30cm	155192	24158	4432	155275	
154534	40cm	155200	24158	4531	155283	

Automatic spray guns

Ext. No.	Length	Pos 10	Pos 20	Pos 40	Pos 50
164277	20cm	155184	24158	24182	46490
164285	30cm	155192	24158	4432	47100
	40cm	155200	24158	4531	47688

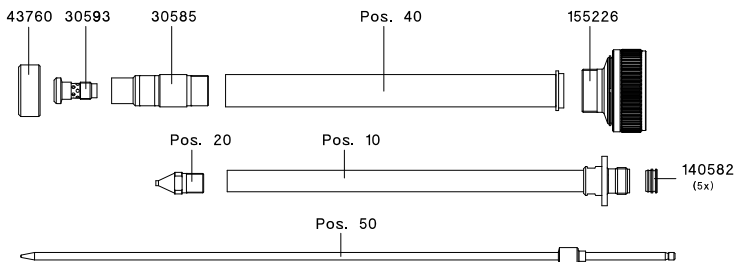

Technical modifications and printing errors reserved

SATAjet® 100 B F RP®/HVL P, SATAjet® 100 B P



SATAjet 100 B F HVL P				
Technical Data				Inlet pressure: 29 psi
				Air consumption: 12.4 cfm @ 36 psi
				Spray distance: 5-7 in
Nozzle	1.4	1.7	1.9	2.1
Standard gun with 0.6 l QCC PVC cup				
Order No.	146373	145722	145730	145748
Standard gun with 0.75 l QCC aluminum cup				
Order No.	147447	146175	146183	147454
Standard gun with 1.0 l aluminum cup				
Order No.	146399	146191	146209	147462
Test Air Cat	157214			
Nozzle	1.4	1.7	1.9	2.1
Nozzle Set				
Order No.	146381	145417	145425	145433



SATAjet 100 B F RP				
Technical Data				Inlet pressure: 7-29 psi
				Air consumption: 10.2 cfm @ 29 psi
				Spray distance: 5-7 in
Nozzle	1.4	1.6	1.8	2.0
Standard gun with 0.6 l QCC PVC cup				
Order No.	146969	145193	145201	145219
Standard gun with 0.75 l QCC aluminum cup				
Order No.	153023	146134	146142	147421
Standard gun with 1.0 l aluminum cup				
Order No.	153460	146159	146167	147439
Nozzle	1.4	1.6	1.8	2.0
Nozzle Set				
Order No.	146977	145250	145268	145276



SATAjet 100 B P	
Technical Data	Inlet pressure: 29 psi
	Air consumption: 8.7 cfm @ 29 psi
	Spray distance: 18-23 cm / 5-7 in
Nozzle	P
Standard gun with 0.6 l QCC PVC cup	
Order No.	145185
Standard gun with 0.75 l QCC aluminum cup	
Order No.	146217
Standard gun with 1.0 l aluminum cup	
Order No.	147470
Nozzle	P
Nozzle Set	
Order No.	145284

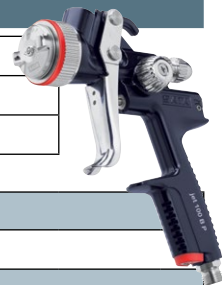

Technical modifications and printing errors reserved

Spare Parts SATAjet® 100 B

Order No./Desc.

240	Packing, air piston
901	Wrench, universal spanner
1503	Screw, fan control
1826	Non-drip device (4 pk)
3426	Circlip, pin
3509	Brush, large standard
3624	Pin, air micrometer
3699	Pin, lower trigger
3988	Sieve, pk of 20
3988-5	Sieve, pk of 5
6007	Brush, nozzle cleaning, pk of 10
6395	Disc, CC (standard), pk of 4
6585	Insert, aluminum cup
9050	Tool kit
9647	Allen wrench, 4mm
12591	Pin, upper trigger
14605	Bushing, needle packing
14993	Spring, needle packing
15438	Kit, needle packing
17525	Washer, tension spring
17897	Spring, paint needle
23275	Packing, needle
27243	Cup, 0.6L QCC plastic
43638	Puller, wire air ring
49395	Lid, 0.6L plastic
49437	Cup Lid Drip Ring, 0.6L, (5 pk)
69872	O Ring, fan control
71555	Lid, plastic, (3 pk)
89771	Control spindle, flat/round, w/"O"ring
82826	Kit, air piston service
91959	Piston, air rod
92759	Service set, air piston
96875	Seal, inner cup
130393	Seal, air cap ring
130492	Kit, trigger service complete
130542	Repair kit, SATAjet 100 B series
133884	Kit, battery, cover w/gasket
133926	Kit, trigger sleeve
133934	O ring, fan control, (3 pk)
133942	Bushing, air piston
133959	Kit, spring, (3 ea. of #215806 & #17897)
183780	Sealing kit
215806	Spring, air piston

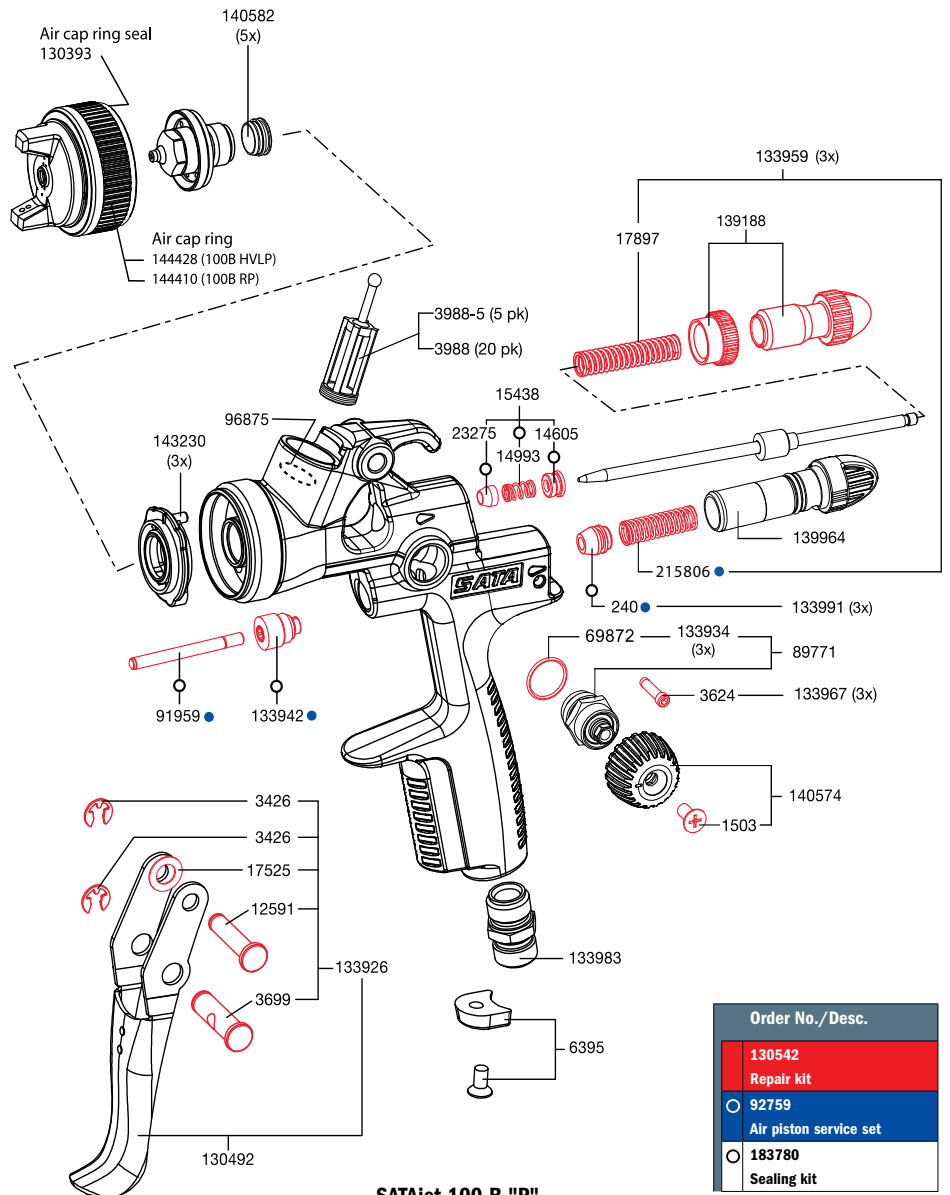

Order No./Desc.
130542 Repair kit
92759 Air piston service set
183780 Sealing kit

Order No./Desc.

133967	Pin, air micrometer, (3 pk)
133983	Fitting, standard 1/4" air inlet
133991	Packing, air piston, (3 pk)
139188	Kit, fluid control and lock nut
139964	Air micrometer, HVLP & RP only
140574	Knob, fan control w/ screw
140582	Fluid tip seal (5 pk)
143230	Air distribution ring (3 pk)
144410	Air cap ring with seal (RP)
144428	Air cap ring with seal (HVLP)
Only with SATAjet 100 B "P" version:	
25874	"O" ring 9 x 1.5
78154	Closing cap w O ring seal

SATAjet 100 B "P"

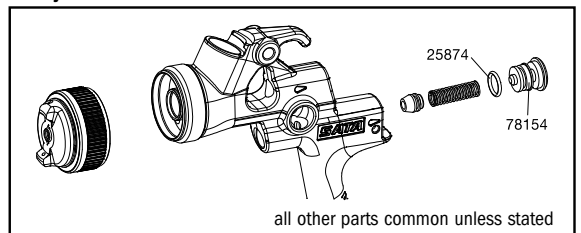

all other parts common unless stated

9050 Tool Kit

901	Universal spanner wrench
3509	Cleaning brush
9647	Allen/Torx wrench
64543	Allen wrench
43638	Extraction tool



Technical modifications and printing errors reserved



SATAmijet® 1000 K RP®/HVL



SATAmijet 1000 K RP							
Technical Data		Inlet pressure: 36 psi					
		Air consumption: 7 cfm @ 36 psi					
		Spray distance: 6 - 8 in					
		Weight: 10 oz.					
		Material connection: G 1/4 male thread					
Nozzle	0.3	0.5	0.8	1.0	1.2	1.4	
Spray gun							
Art. No.	187450	187468	187476	187484	187492	197152	
Nozzle set							
Art. No.	187625	187633	187641	187658	187666	197160	
Test Air Cap	204867 RP						



SATAmijet 1000 K HVL							
Technical Data		Inlet pressure: 29 psi					
		Air consumption: 4.2 cfm @ 29 psi					
		Spray distance: 4 - 6 in					
		Material connection: G 1/4 male thread					
Nozzle	0.3	0.5	0.8	1.0	1.2		
Spray gun							
Art. No.	190280	190298	190306	190314	190322		
Nozzle set							
Art. No.	190348	190355	190363	190371	190389		
Test Air Cap	204875 HVL						

Accessories			
187419	Paint pipe, cpl. G1/4 - G1/4		
199018	Paint pipe, cpl. G1/4 - G3/8		
187690	SATA material filter 60 msh, G 1/4		
191551	Adapter, G 1/4 female and G 3/8 male material connection		

Technical modifications and printing errors reserved

Spare Parts SATAminijet® 1000 K

Order No./Desc.	
6395	ColorCode discs, pk of 4
22566	Pin, upper trigger
26583	Circlip
44644	Lock nut
44669	Spring, needle
44677	Pin, lower trigger
44735	Screw, fan control
44818	Spring, air piston
44826	Packing, air piston
44834	Air piston
44842	Bushing, needle packing
44859	Packing, needle
50658	Packing set, minijet
62810	Piston packing
68809	Spring, needle packing
79905	Needle packing service set
124164	Knob, fan control
125112	Snap ring (air cap ring)
125146	Knob, fluid control
125187	Air micrometer
125377	Bushing, air piston
125492	Trigger
125856	Tool set
126037	Washer, tension spring
126276	Trigger service set
187427	Fan control
187435	Air distribution ring, pack of 3

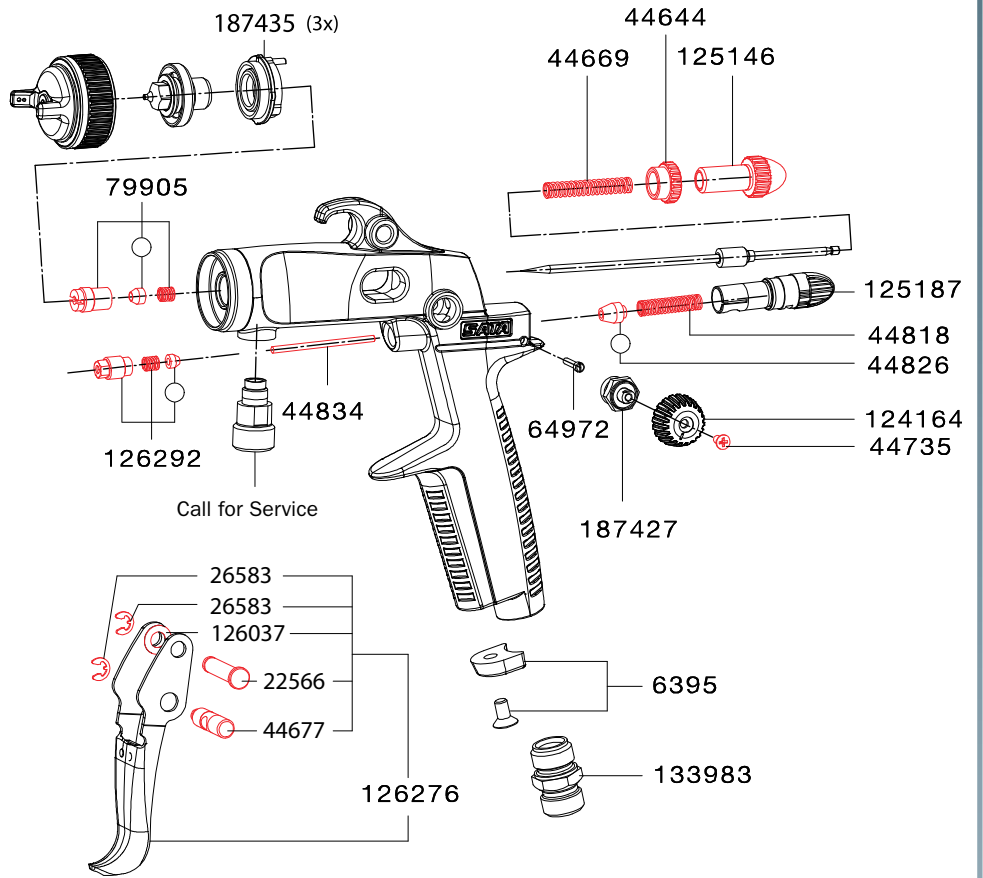

Technical modifications and printing errors reserved

125856 Tool Kit	
901	Universal spanner wrench
3509	Cleaning brush
15925	Wrench, multi
43638	Extraction tool



Art. No./Desc.	Euro
126284	
Repair kit	
○ 50658	
Packing Set	



SATAmijet® 1000 H RP®/HVL

SATAmijet 1000 H RP without cup

Technical Data		Inlet pressure: 36 bar	
		Air consumption at 7 cfm @ 36 psi	
		Spray distance: 6.5 - 8.5 in.	
		Weight: 10.1 oz.	
Nozzle	1.4	1.4 ST	
Spray gun without cup			
Art. No.	187682	inquire	
Nozzle set			
Art. No.	187674	*202036	



*Lifetime prolonging surface treatment

SATAmijet 1000 H HVL without cup

Technical Data		Inlet pressure: 29 psi	
		Air consumption at 4.1 cfm @ 29 psi	
		Spray distance: 4 - 6 in.	
		Material connection: G 1/4 male thread	
Nozzle	1.4		
Spray gun without cup			
Art. No.	191502		
Nozzle set			
Art. No.	191494		



Accessories for SATAmijet 1000		
188318	RPS Adapter No. 17 with QCC Connection thread G 1/4 To use for RPS siphon cup.	
188482	RPS Siphon Kit, pins, suction hose, sieve, (for 0.3L cup), pack of 25	
188516	RPS Siphon Kit, pins, suction hose, sieve, (for 0.3L cup), pack of 50	
188490	RPS Siphon Kit, pins, suction hose, sieve, (for 0.6L cup), pack of 25	
188524	RPS Siphon Kit, pins, suction hose, sieve, (for 0.6L cup), pack of 50	
188508	RPS Siphon Kit, pins, suction hose, sieve, (for 0.9L cup), pack of 25	
188532	RPS Siphon Kit, pins, suction hose, sieve, (for 0.9L cup), pack of 50	

Spare Parts SATAminijet® 1000 H

Order No./Desc.	
6395	Color Code discs, pk of 4
22566	Pin, upper trigger
26583	Circlip
44644	Lock nut
44669	Spring, needle
44677	Pin, lower trigger
44735	Screw, fan control
44818	Spring, air piston
44826	Packing, air piston
44834	Air piston
44842	Bushing, needle packing
44859	Packing, needle
50658	Packing set, minijet
62810	Piston packing
68809	Spring, needle packing
79905	Needle packing service set
124164	Knob, fan control
125112	Snap ring (air cap ring)
125146	Knob, fluid control
125187	Air micrometer
125377	Bushing, air piston
125492	Trigger
125856	Tool set
126037	Washer, tension spring
126276	Trigger service set
187427	Fan control
187435	Air distribution ring, pack of 3

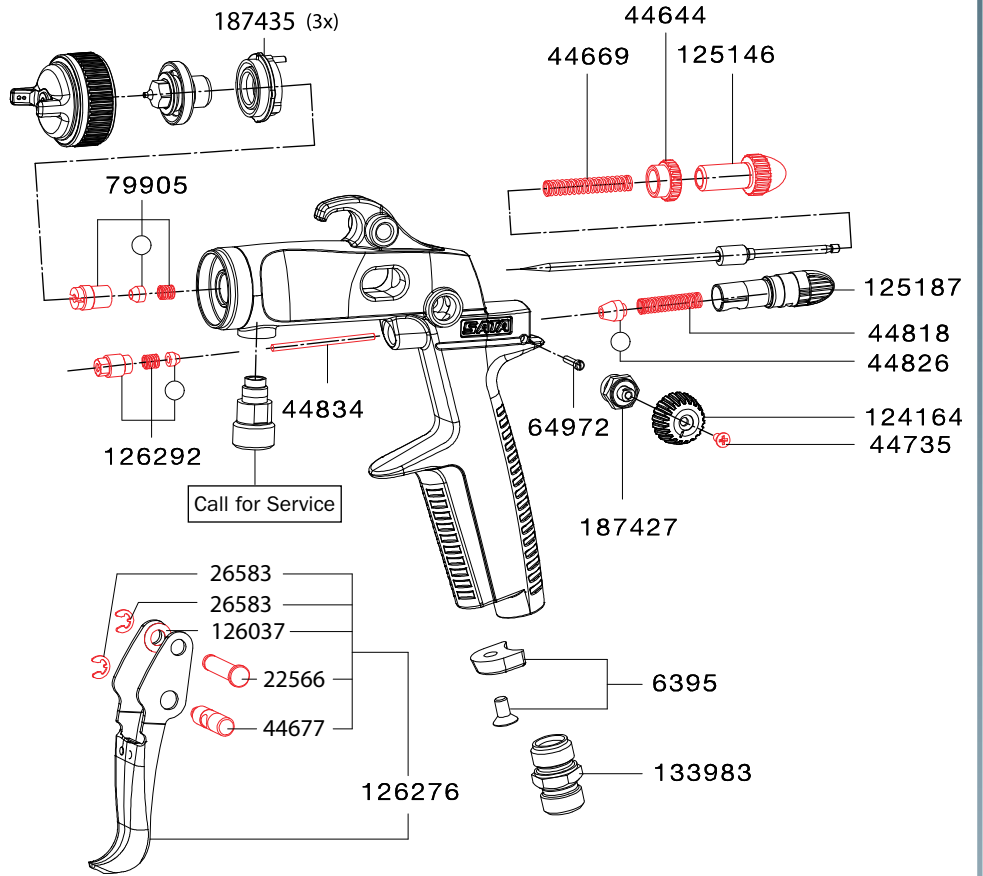

Technical modifications and printing errors reserved

125856 Tool Kit	
901	Universal spanner wrench
3509	Cleaning brush
15925	Wrench, multi
43638	Extraction tool



Art. No./Descr.	Euro
126284	
Repair kit	
○ 50658	
Packing Set	

SATAjet® 20 B



SATAjet 20 B

Conventional Gravity or Siphon Design Gun

Use for hobbies, silk screening, lettering, graphic arts, woodworking or unique design.

An endless list of possibilities for any kind of design work make the SATAjet® 20 B a great choice. This round spray design gun is perfect for vehicle murals, graphic design, calligraphy, airbrushing and many hobbies. Five nozzle sizes from 0.2 to 1.0 add to its versatility. Two separate air inlets may be interchanged without any tools - in the handle or at the backside of the gun. That means it can be handled like a typical spray gun or like an airbrush. The unique design of the SATAjet 20 B allows it to be used by left- or right-handed artists. The gravity cup is easily removed and an adapter switches it to a siphon gun with plug-in cups. These plug-in cups allow quick and easy changing of one color to the next.

The SATAjet 20 B is an excellent choice for a glazing spray gun for the wood industry.

With a controlled application, the material savings and wiping time are significantly reduced.

Nozzle sets with stainless steel needle and fluid tip are standard making them compatible for waterborne. The SATAjet 20 B has self-adjusting Teflon seals and the gun body is finished in durable nickel plating.

Lightweight at only 6.3 oz and low air consumption at 1.4 cfm @ 15 psi makes it ideal for continuous work load. Additionally it can be converted to a pressure fed spray gun for continuous work (*call for setup*).

The most common nozzle size for applying glaze and wiping is 0.5. For pinpoint glazing and no wiping use a 0.2 nozzle.



Technical Data

Inlet pressure: 15 psi

Air consumption: 1.4 cfm at 15 psi

Spray distance: variable

Nozzle	0.2	0.2 F*	0.35	0.35**	0.5	0.8	1.0
--------	-----	--------	------	--------	-----	-----	-----

Spray gun with 65 ccm plastic cup

Order No.	65078	189035	65581		65649	66316	69229
-----------	-------	--------	-------	--	-------	-------	-------

Spray gun with 1 plug-in cap and 4 blind cups, including adapter

Order No.	86181	call	86199		86207	86215	86223
-----------	-------	------	-------	--	-------	-------	-------

Nozzle	0.2	0.2 F*	0.35		0.5	0.8	1.0
--------	-----	--------	------	--	-----	-----	-----

Nozzle Set

Order No.	60459	189043	60640	202515**	61200	61341	61523
-----------	-------	--------	-------	----------	-------	-------	-------

*F = Fineline ** Lifetime prolonging surface treatment

SATA jet 20 B design set

90381	SATAjet 20 B design set:	
	<ul style="list-style-type: none"> • SATAjet 20 B spray gun • 1) 0.5 nozzle • 1) 0.025 l glass plug-in cup • 1) air micrometer w/ gauge • 1) funnel/sieve • 1) 6 ft PVC hose 	<ul style="list-style-type: none"> • 1) 0.2 nozzle (Specify nozzle size or will ship with 0.2) • 4) 25 ml glass cup w/ blind lid • 1) adapter • 1) packing set • 1) cleaning set • 1) gun holder



Accessories for SATA pressure fed spray guns

69328	Gun holder, gravity or siphon cup
53033	Plug-in cups, pack of 5, w/siphon lid
58164	Plain cups, pack of 5, w/blind caps
125963	Plug-in cup adapter & set of 5 plug-in cups, 20 B & MiniJet 3000 B
125955	QCC Plug-in cup adapter 20 B MiniJet 3000 B



Technical modifications and printing errors reserved

Spare Parts SATAjet® 20 B

Order No./Desc.	
3509	Cleaning brush
6007	Standard cleaning brush, pk of 10
9860	Air micrometer without gauge
9878	Mini water separator
15669	65cc plastic gravity cup
15909	65cc cup lid
15925	Spanner wrench
16295	25 ml plug-in cup, complete
32987	Air hose, PVC, w/QC nipple
22566	Pin, upper trigger
26583	Circlip
44677	Pin, lower trigger
44818	Spring, air piston
44826	Packing, air piston
44834	Air piston
50807	Air piston service set
52282	Bushing, air piston
52373	QC nipple
53033	25 ml plug-in cup, pk of 5
54353	Air hose, PVC, 2m, w/ fittings
55749	Trigger
58164	25 ml glass cup, pk of 5
62042	Spray gun handle
62083	Air tube
62398	Nozzle spindle
62729	End screw
62802	Compression bushing
62810	Needle packing
62851	Needle bushing
62869	Knob, fluid control
64758	O ring, 8x1
66928	Air inlet fitting
68809	Spring, needle packing
68817	Spring, needle
69344	Needle packing service set
69427	Packing set, SATAjet 20 B
70326	Allen wrench
74351	Gasket, air hose
79913	Trigger service set
91165	Repair kit, SATAjet 20 B
125955	Plug-in cup connection
125963	Plug-in cup set, connection adapter, 5 glass cups 25cm, 1 plug-in lid, 4 blind lids

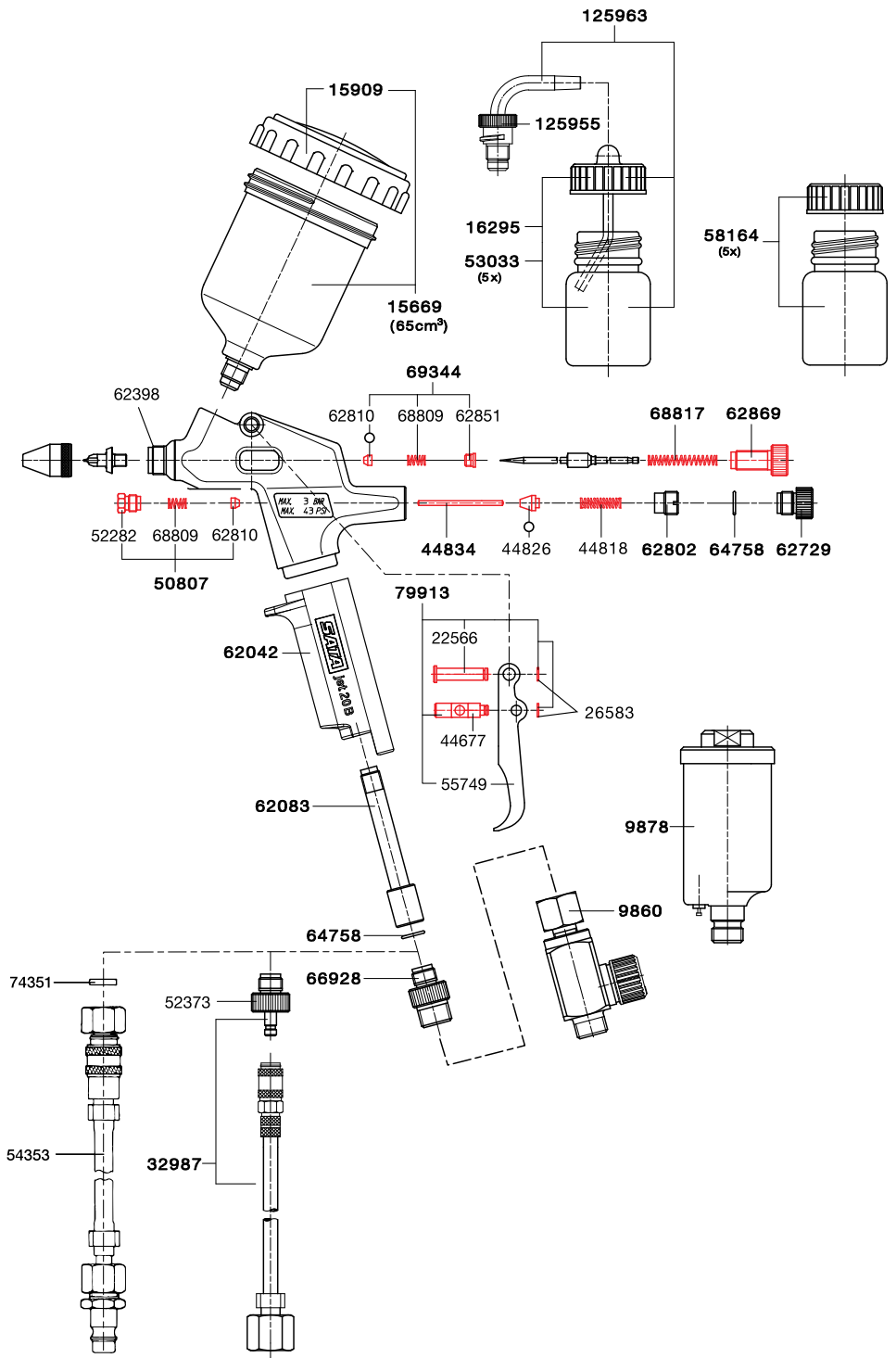

Technical modifications and printing errors reserved

125856 Tool Kit	
3509	Cleaning brush
15925	Wrench, multi
70326	Hex screw driver



Order No./Desc.
91165
Repair kit
<input type="radio"/> 69427
Sealing set

SATAgraph™ 1/2/3

1 - The Starter Model

Technical Data	Inlet pressure: variable
	Air consumption: 0.4 cfm at 14 psi
	Spray distance: variable



Nozzle	0.25	0.45
---------------	------	------

SATAgraph 1 - with 2.5 ml gravity cup, no air hose

Order No.	134544	136069
------------------	--------	--------

SATAgraph 1 - with 5.0 ml siphon cup, no air hose

Order No.	139568	141408
------------------	--------	--------

Nozzle	0.25	0.45
---------------	------	------



Nozzle Set

Order No.	134619	134635
------------------	--------	--------

SATAgraph 2 - The Universal Airbrush

Technical Data	Inlet pressure: variable
	Air consumption: 0.4 cfm at 29 psi
	Spray distance: variable



Nozzle	0.20	0.25
---------------	------	------

SATAgraph 2 with 4.0 ml gravity cup, 15.0 ml siphon cup, no air hose

Order No.	135079	134536
------------------	--------	--------

SATAgraph 2 with 4.0 ml gravity cup, 15.0 ml siphon cup, & 3 m PVC air hose

Order No.	123430	5082
------------------	--------	------

Nozzle	0.20	0.25
---------------	------	------



Nozzle Set

Order No.	123448	31476
------------------	--------	-------

SATAgraph 3 - Premium Airbrush for Professionals

Technical Data	Inlet pressure: variable
	Air consumption: 0.4 cfm at 36.3 psi
	Spray distance: variable



Nozzle	0.15	0.25	0.45	0.65
---------------	------	------	------	------

SATAgraph 3 - with 2.5 ml gravity cup, no air hose

Order No.	136077	134569	136085	-
------------------	--------	--------	--------	---

SATAgraph 3 - with 5.0 ml siphon cup, no air hose

Order No.	-	134585	136093	136101
------------------	---	--------	--------	--------

Nozzle	0.15	0.25	0.45	0.65
---------------	------	------	------	------



Nozzle Set

Order No.	134643	134650	134668	134676
------------------	--------	--------	--------	--------

Technical modifications and printing errors reserved

Spare Parts SATAgaph™ 1/2/3

Order No./Desc.
SATAgaph 1
32615 coupling nipple, Pk of 3
134767 2.5 ml gravity flow cup w/ lid
134775 5.0 ml gravity flow cup w/ lid
134783 5.0 ml siphon cup w/ lid
134809 Trigger
134825 Grip end piece
138909 O-ring kit for paint nozzle (5-pieces)
142638 O-ring kit for gravity flow cup (5-pieces)

SATAgaph 1

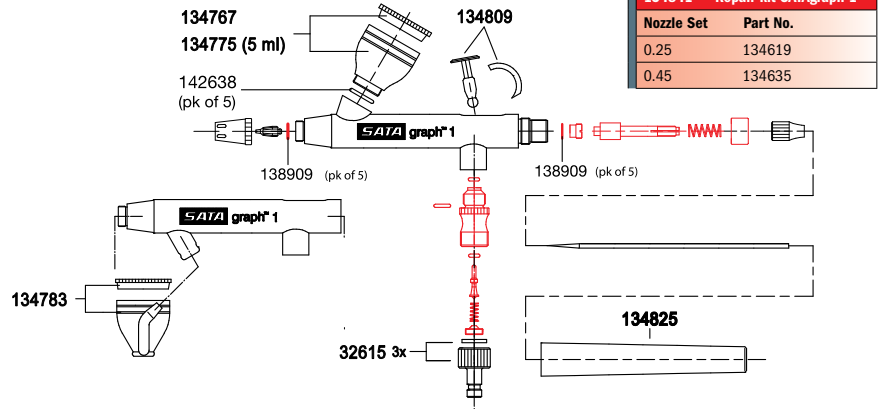

Order No./Desc.
134841 Repair kit SATAgaph 1
Nozzle Set Part No.
0.25 134619
0.45 134635

Order No./Desc.
SATAgaph 2
31781 4.0 ml gravity flow cup w/ 3 plastic lids
32029 Plastic lids for 4.0 ml gravity flow cup, pk of 3
32615 pk of 3 coupling nipples
33001 Grip / end piece
33019 15 ml glass cup w/ lid and suction pipe
33092 15 ml glass cups, 5 closing lids and 1 lid with suction pipe, pk of 5
35964 Needle cap
36020 Trigger
138909 O-ring kit for paint nozzle (5-pieces)

SATAgaph 2

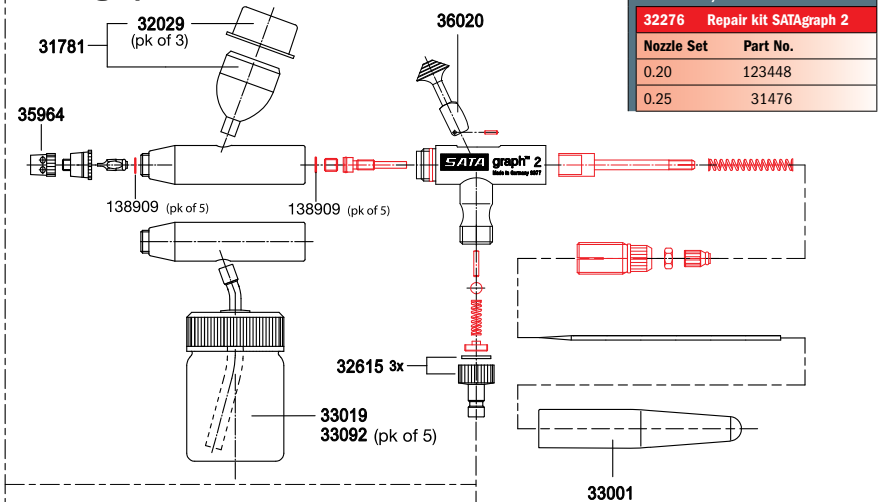

Order No./Desc.
32276 Repair kit SATAgaph 2
Nozzle Set Part No.
0.20 123448
0.25 31476

Order No./Desc.
SATAgaph 3
32615 pk of 3 coupling nipples
134767 2.5 ml gravity flow cup w/ lid
134775 5.0 ml gravity flow cup w/ lid
134783 5.0 ml siphon cup w/ lid
134817 Needle cap
134833 Grip end piece, cpl.
134957 Trigger
138909 O-ring kit for paint nozzle (5-pieces)
142638 O-ring kit for gravity flow cups (5-pieces)

SATAgaph 3

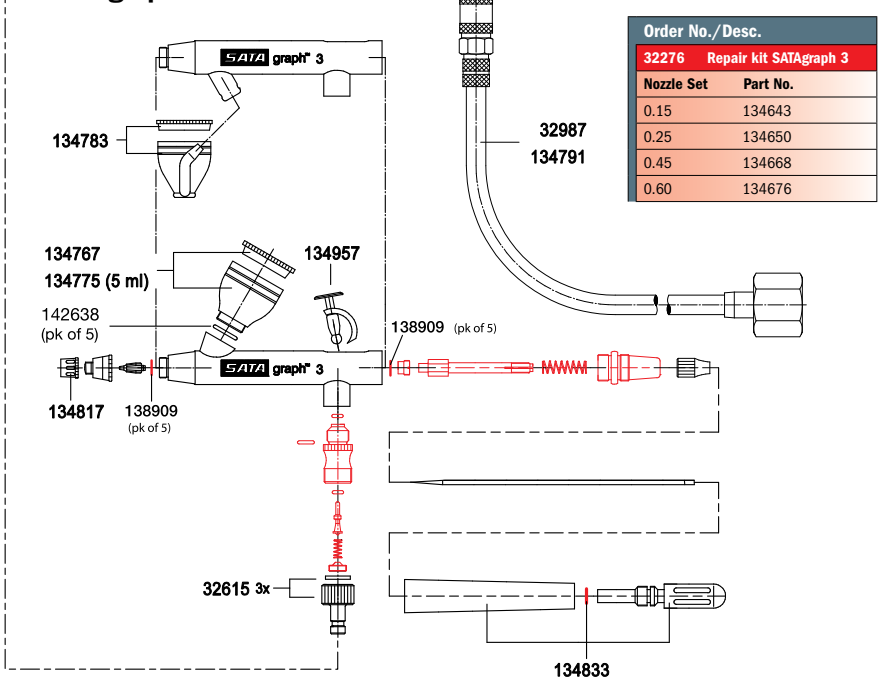

Order No./Desc.
32276 Repair kit SATAgaph 3
Nozzle Set Part No.
0.15 134643
0.25 134650
0.45 134668
0.60 134676

Technical modifications and printing errors reserved

SATAgraph™ 4

SATAgraph 4 B - Gravity Feed

Technical Data	Inlet pressure: variable
	Air consumption: 0.4 cfm at 14.5 psi
	Spray distance: variable
Nozzle	0.40



SATAgraph 4 B with 2.5 ml gravity cup, no air hose

Order No.	S004B
Needle	0.40
Order No.	S005



SATAgraph 4 S - Side Feed

Technical Data	Inlet pressure: variable
	Air consumption: 0.4 cfm at 14.5 psi
	Spray distance: variable
Nozzle	0.40



SATAgraph 4 S with 2.5 ml side feed cup, no air hose

Order No.	S004S
Needle	0.40
Order No.	S005



SATAgraph 4 H - Siphon Feed

Technical Data	Inlet pressure: variable
	Air consumption: 0.4 cfm at 14.5 psi
	Spray distance: variable
Nozzle	0.40



SATAgraph 4 S with 2.5 ml siphon cup, no air hose

Order No.	S004H
Needle	0.40
Order No.	S005



SATAgraph 4 B, H, K

SATAgraph 4, 3 gun kit includes all 3 SATAgraph 4 airbrushes, S004B, S004S and S004H, also included is a (1) S0323, 3/4 oz glass jar with siphon lid, (1) S039, 1 oz. glass cup with side feed lid, (1) S045, 6 ft braided hose with quick disconnect, (3) Quick connect plug/fittings, female, (1) foam padded case with handle

Nozzle 0.40

SATAgraph 4 HBS three gun kit

Order No.	S004HBS
Needle	0.40
Order No.	S005



Technical modifications and printing errors reserved

Spare Parts SATAgaph™ 4 B/S/H

Order No./Desc.	
S001	Airbrush needle, 0.40
S002	Nozzle tip (fluid tip)
S003	Nozzle cap (inner air cap)
S004	Nozzle cap shield (outer air cap nozzle shield reversible)
S005	Needle/nozzle refurbish kit (includes 001, 002, 003, 004)
S006	Nozzle base
S007	O-ring, nozzle base
S008	Nozzle base wrench
S009	Air valve chamber
S010	Trigger valve stem
S011	Trigger valve spring
S012	Air valve seal / o-ring
S013	Air valve screw
S014	Complete air valve assembly (includes 009, 010, 011, 012, 013)
S015	Inner seal screw and O-ring (gravity and side cup models)
S016	Airbrush trigger
S017	Needle alignment tube and lever assembly
S018	Needle tube spring
S019	Spring tension adjustment knob
S020	Needle locking nut
S021	Needle alignment and adjustment assembly (includes 017, 018, 019, 020)
S022	Bottom (siphon) feed airbrush body
S023	Gravity feed airbrush body
S024	Side feed airbrush body
S025	O-ring, airbrush handle
S026	Trigger stop set handle, red
S027	Trigger stop set screw
S028	Trigger stop set handle and screw (includes 026, 027)
S029	Protective nozzle cover
S030	Siphon lid, metal, fits 3/4 oz. glass cup
S031	3/4 oz. glass cup w/blank storage lid for (S)
S032	3/4 oz. glass cup w/siphon lid for (S) metal lid
S033	1/4 oz. color cup (siphon cup-metal)
S034	Side feed metal color cup
S035	Side feed inlet plug, red
S036	Lid, metal, for side (S) and gravity (B) feed color cup
S037	Lid, metal side feed lid for 1 oz. glass cup
S038	1 oz. glass cup w/blank metal storage lid
S039	1 oz. glass cup with metal side feed lid
S040	6 foot braided air hose 1/8 inch X 1/4"
S041	10 foot braided air hose 1/8" X 1/4"
S042	6 foot braided air hose w/ moisture trap
S043	10 foot braided air hose w/ moisture trap
S044	In-line moisture trap
S045	8 foot quick dis-connect braided air hose
S046	Quick disconnect plug/fitting, female
S047	Siphon lid, plastic, fits 3/4 oz. glass cup
S048	3/4 oz. glass cup w/siphon lid for (H) plastic lid
S049	Pvc lid for 1/4 oz metal siphon color cup
S050	Quick dis-connect air coupler, male
S051	PVC color cup lid Gravity feed (B) and Side feed (S).
S004B	SATAgaph 4 B Gravity feed airbrush
S004S	SATAgaph 4 S Side-feed airbrush
S004H	SATAgaph 4 H Bottom-feed siphon airbrush

SATAgaph 4 B

Gravity cup
S004B

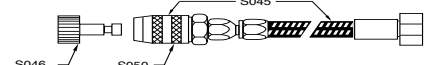
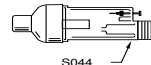
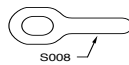
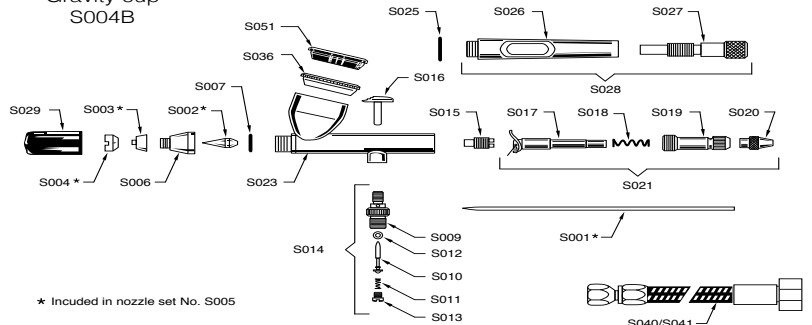

SATAgaph 4 S

w/side mount cup
S004S

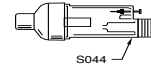
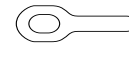
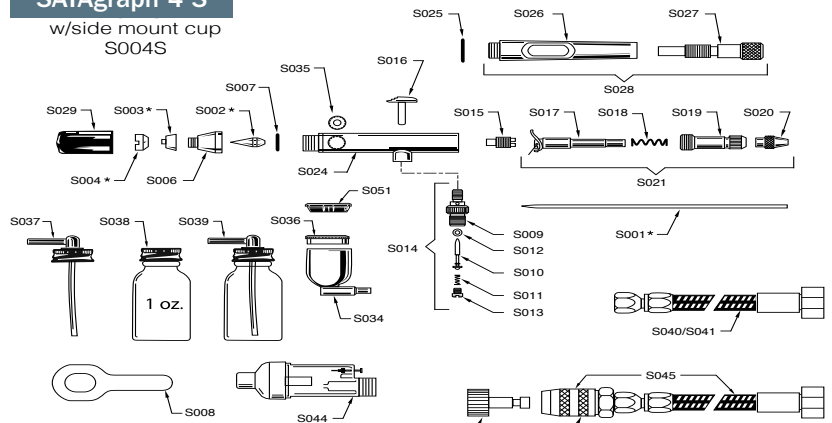

SATAgaph 4 H

w/siphon cup
S004H

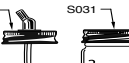
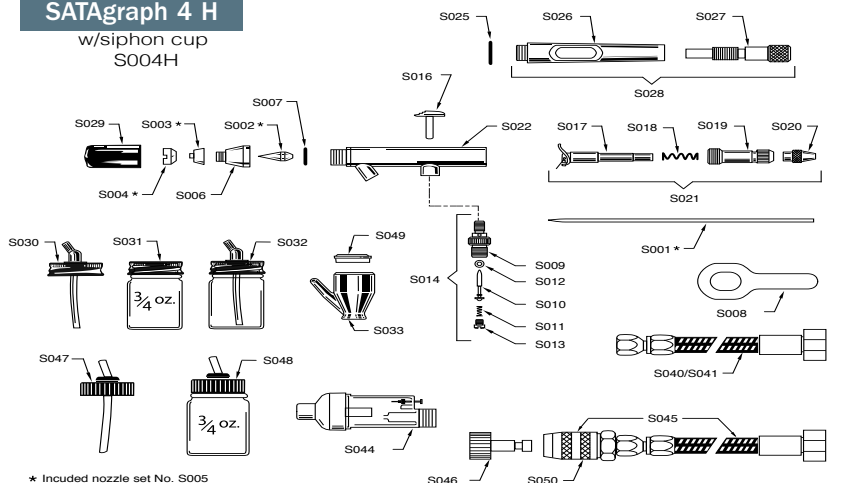

Technical modifications and printing errors reserved

Spare Parts for Gravity feed SATA Spray Guns

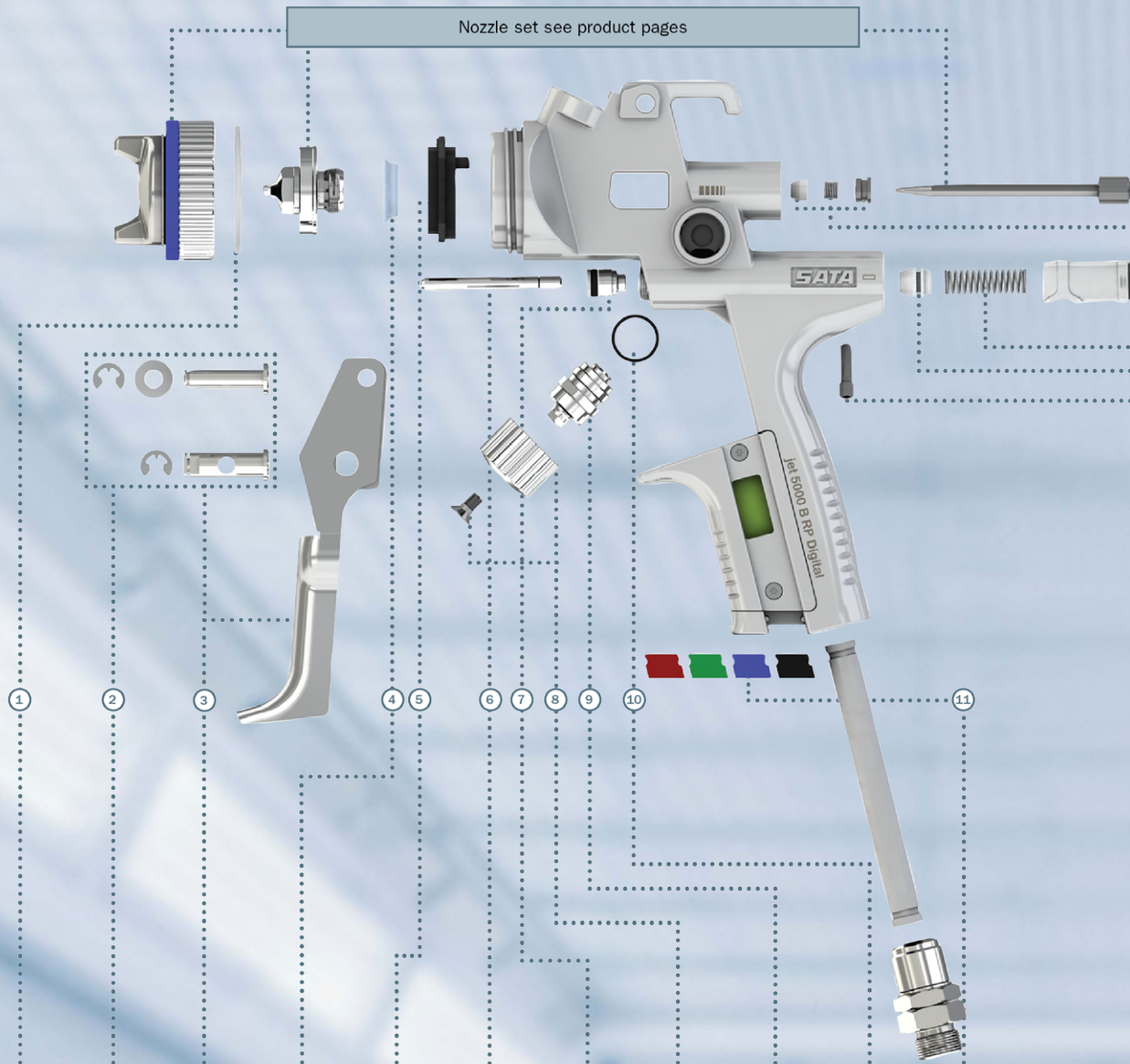



	1	2	3	4	5	6	7	8	9	10	11	
Description	Seal ring	Trigger sleeve kit	Trigger kit	Seal element fluid tip	Air distribution ring	Air piston rod	Seal retainer	Control knob	Spindle with seal	Spindle seal	CCS clips	
Gun type	3000 B	143834	133926	133850	-	97824		134031	89771		6395	
	4000 B	172429	166009	165977		165951	86843	166033	165944		165928	
	5000 B	211508	211458	211433		211425		211482	213025	133934	211409	
	100 B				140582							
	1000 B	-	133926	130492		143230	91959	140574	89771		6395	
	minijet 3000 B		-	126276	-	127399	44834	126292	124164*	125351	125344 sm - 131037 lg	
	minijet 4400 B	200907	199463	198473	199455	197467	198408	199414	200162	198549	199471	197418

* screw #44735 to be ordered separately

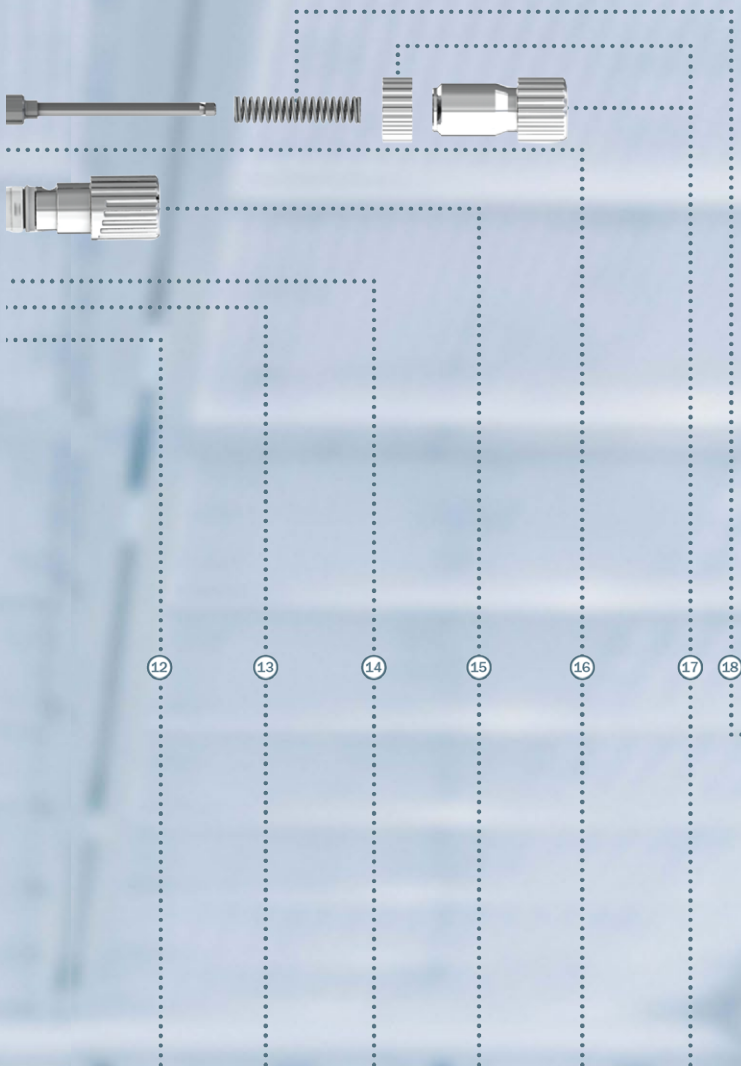
Spare Parts for Gravity feed SATA Spray Guns



Air connection piece		
Spray gun	Standard	Standard swivel joint
3000 B		
4000 B	134098	19745
5000 B		
100 B		
1000 B		
minijet 3000 B	133983	16162
minijet 4400 B		

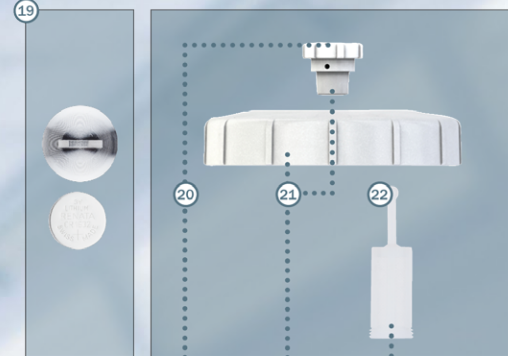

12	13	14	15	16	17	18	19	20	21	22	Description	Gun type
Locking screw	Air piston head	Pressure spring air piston	Air micrometer	Paint needle packing	Material flow control	Pressure spring paint needle	Battery kit	Anti-drip device	Screw-on lid	Strainer 300µm		
133967			134015		134023		133884				3000 B	
			166017		166025		165993				4000 B	
211391	133991	133959**	211466	15438	211474	133959**	213769	1826	49395	3988-5 (5x)	5000 B	
133967			139964		139188				0.6l pvc	3988 (20x)	100 B	
											1000 B	
64972	44826	201467**	125187	79905	125146***		-	95489	95448	-	minijet 3000 B	
199430	199448	201467**	198523	199414	199406			197558	199075	see above	minijet 4400 B	
									125 ccm pvc			
									125 ccm pvc			

** in a set

*** counter nut #44644 to be ordered separately

Nozzle Sets for Older Model SATA Spray Guns

SATA Spray Guns

Nozzle Size	SATAJET 90-2 HVLP	SATAJET 90-2 RP	SATAJet 3000 HVLP	SATAJet 3000 RP	SATAJet 2000 HVLP	SATAJet RP	SATAJet B	NR92/95 HVLP	SATAJet K NR-92 NR-95 HVLP	SATA MC-B HVLP	SATA Jet 90	Nozzle Size
0.2												0.2
0.3												0.3
0.4												0.4
0.5									73908			0.5
0.8									79780			0.8
0.8SR												0.8SR
0.9												0.9
1.0			132910	132357	82024	29587	4143	46334	79798			1.0
1.0SR												1.0SR
1.1				158667								1.1
1.2			132928	132365	82057	14902		NLA	79806			1.2
1.2SR												1.2SR
1.3	126102	123257	132936	132373	82073	14910	4127 _{MSB}	NLA			56051	1.3
1.3 LV			161331									1.3 LV
1.3 C												1.3 C
WSB			132993		9191							WSB
1.4	126110	123265	132944	132381	82263	14936	3848	NLA	79277	52324	56077	1.4
1.4 HC			145797									1.4 HC
1.4 SR												1.4 SR
1.5			132951		82420		4119	NLA				1.5
1.6				132399		14977					51482	1.6
1.6 NA												1.6 NA
1.7			132969		90399		4101	46193		NLA		1.7
1.8				132407		97998						1.8
1.9			132977		90407			NLA		64014		1.9
2.0				132415		69880	4093		77917			2.0
2.1										83618		2.1
2.2			132985		90415			46201				2.2
2.5				132423		69898	13003					2.5
P												P
2.6												2.6
3.0												3.0
4.0												4.0
5.0												5.0
Repair Kits	57620	57620	133835	133835	57620	57620	9720	NR95 - NLA NR92 (9720)	70623	71464	57430 55178	Repair Kits

* Above sn 85,000 (below 85,000 - part no. 55178) ** Above sn 6,000 (below 6,000 - part no. 69377)
 NLA = No Longer Available

Technical modifications and printing errors reserved

Nozzle Sets for Older Model SATA Spray Guns

SATA Spray Guns

Nozzle Size	◆ SATA Jet/K ▲ Jet/H	SATA MC-B MC-93	SATA LM 92 B, H, K	SATA minijet4 & 3000 B	SATA minijet 2 & 3 HVLP	SATA minijet HVLP Green	SATA dekor	SATA KLC-B HVLP	SATA KLC RP	SATA LM2000 B, H, K RP	SATA LM2000 B, H, K HVLP	Nozzle Size
0.2							NLA					0.2
0.3				125583	91041							0.3
0.4							5280					0.4
0.5				125591	91058		NLA					0.5
0.8	◆ 61358		6734	125609	91066	NLA	5264			26690		0.8
0.8SR				125682	53454							0.8SR
0.9											26823	0.9
1.0			6726	125617	91074	NLA	NLA			26716		1.0
1.0SR				125690	51318							1.0SR
1.1	◆ 55814			125625	91082	NLA					26856	1.1
1.2												1.2
1.2SR				125708	88534							1.2SR
1.3	◆ 64592	80788	64444						87973	26724	26864	1.3
1.3 LV												1.3 LV
1.3 C												1.3 C
WSB												WSB
1.4												1.4
1.4 HC												1.4 HC
1.4 SR				125716								1.4 SR
1.5	◆ 64600 ▲ 23663										26872	1.5
1.6		80796	60673						87981	26732		1.6
1.6 NA									88005			1.6 NA
1.7	▲ 23697 _{MSH}								32755		30643	1.7
1.8		NLA	6684						96768	26740		1.8
1.9									32771		30742	1.9
2.0	▲ 23689	80804	6676						87999	26757		2.0
2.1									33415		31047	2.1
2.2												2.2
2.5			6668						88013	26765		2.5
P												P
2.6												2.6
3.0			6650							26781		3.0
4.0										26799		4.0
5.0										26807		5.0
Repair Kits	◆ ▲ 70623	71464	562	126284	50815	50815	91165 69377	12633	12633	54957	54957	Repair Kits

* Above sn 85,000 (below 85,000 - part no. 55178) ** Above sn 6,000 (below 6,000 - part no. 69377)

NLA = No Longer Available

Technical modifications and printing errors reserved

SATAjet® 90-2®



SATAjet 90-2 HVLP

SATAjet 90-2 HVLP sealer spray gun This is an incredible sealer gun for all painters. Perfect topcoats can only be achieved over a perfectly smooth surface. This gun allows that ideal foundation, at an incredibly affordable price.

- Perfect sealer application
- Nice-sized, even spray pattern
- Fast working speed
- Increased transfer efficiency compared to high pressure conventional spray guns
- Anodized spray gun body for easy cleaning and durability
- Excellent value for cost sensitive painters

The balanced design results in required comfort and ergonomics, and the gun's surface will work with any solvent or waterborne product. You'll be quite happy with the performance and finishes you'll achieve with the SATAjet 90-2 HVLP - at an affordable price.



Technical Data	Inlet pressure: 29 psi
	Air consumption: 15.0 cfm at 29 psi
	Spray distance: 5 - 7 in
	Finish: Anodized gray

SATAjet 90-2 HVLP

Nzl Size	1.3	1.4				
Nozzle Set Only						
Order No.	126102	126110				

SATAjet 90-2 RP

Nzl Size	1.3	1.4				
Nozzle Set Only						
Order No.	123257	123265				

Technical modifications and printing errors reserved

Spare Parts SATAjet® 90-2

Order No./Desc.	
109	Air inlet fitting
240	Air piston packing
901	Universal spanner wrench
1503	Fan control screw
3426	Circlip, pin
3509	Standard cleaning brush
3624	Pin, micrometer
3657	Knob, fan control
3699	Pin, lower trigger
3988	Paint sieve, 20 pk
3988-5	Paint sieve, 5 pk
6007	Std. cleaning brush, 10 pk
6213	Trigger Service Set
9050	Tool set, Jet 90-2 HVLP & RP
9647	Allen wrench, 4
12591	Pin, upper trigger
14605	Bushing, needle packing
14993	Packing spring, each
15438	Needle packing service set
17525	Washer, tension spring
17897	Needle spring, each
23275	Needle packing
26518	Fluid control service set
50146	Fluid regulating control
50542	Lock nut, fluid control
53603	Air micrometer
57620	Repair kit, Jet 90-2
64543	Allen wrench, 2
65557	Knob, fan control
69872	Control O ring
82552	Air piston service set
82636	Bushing, air piston
86843	Air piston
89391	Trigger
89771	Fan control
123455	Air ring, 3 pk
215806	Spring, air piston

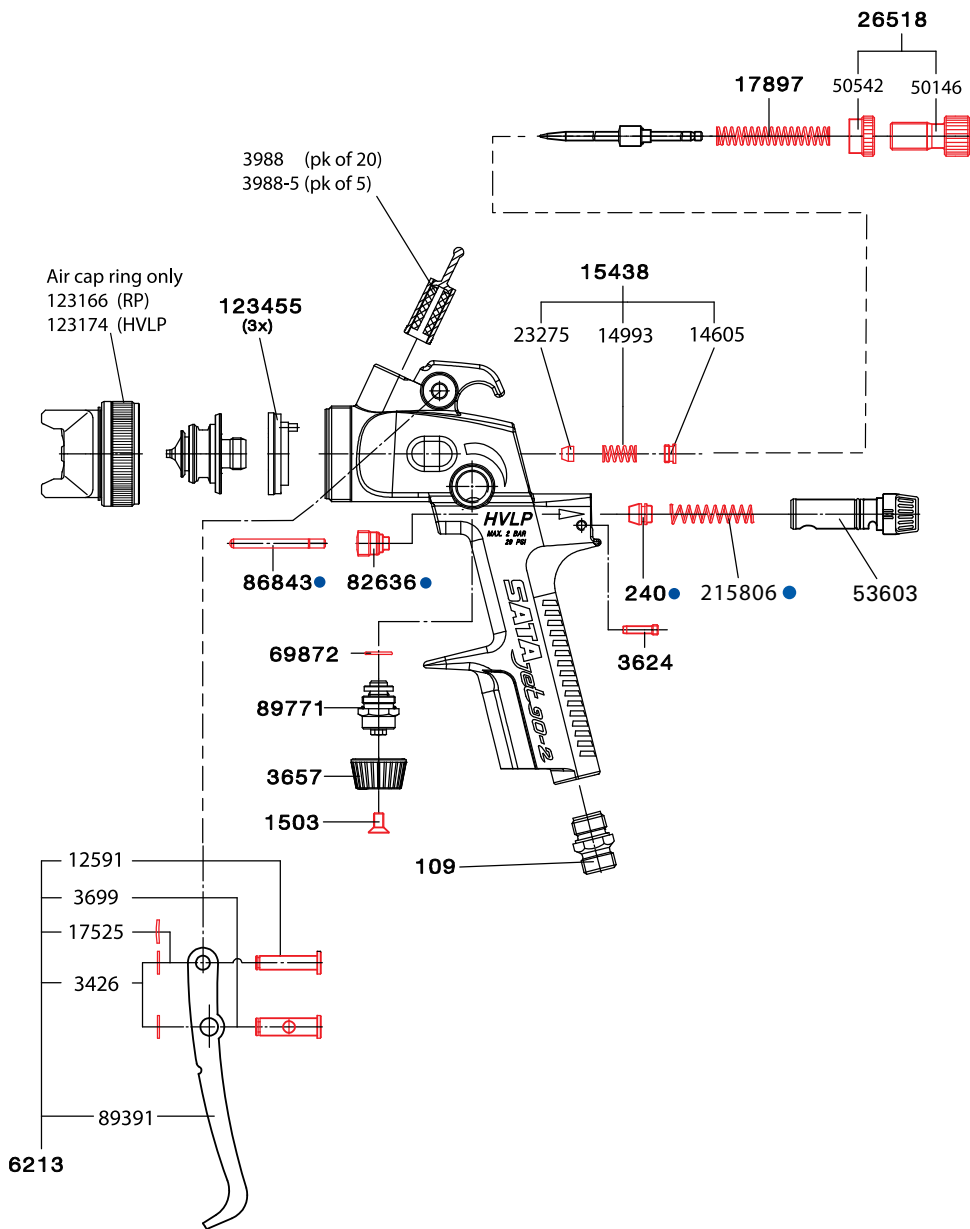

9050 Tool Kit	
901	Universal spanner wrench
3509	Cleaning brush
9647	Allen/Torx wrench
64543	Allen wrench
43638	Extraction tool

Order No./Desc.
57620 Repair kit
82552 Air piston service set

Technical modifications and printing errors reserved



SATAjet® 3000 B RP®/HVLV

SATAjet 3000 B RP (DIGITAL)

Technical Data	Inlet Pressure: 2.0 - 2.2 bar / 29-35 psi
	Air consumption: 2.0 bar: 285 NI/min / 10.4 cfm at 29 psi
	Spray distance: 12 - 21 cm / 6 ^{3/4} in - 8 ^{1/4} in



Nozzle	1.0	1.2	1.3	1.4	1.6	1.8	2.0	2.5
---------------	-----	-----	-----	-----	-----	-----	-----	-----

Nozzle Set

Order No.	132357	132365	132373	132381	132399	132407	132415	132423
------------------	--------	--------	--------	--------	--------	--------	--------	--------

SATAjet 3000 B HVLV (DIGITAL)

Technical Data	Inlet Pressure: 2.0 bar / 29 psi
	Air consumption: 2.0 bar: 430 NI/min / 15.2 cfm at 29 psi
	Spray distance: 13 - 17 cm / 5 in - 6 ^{3/4} in

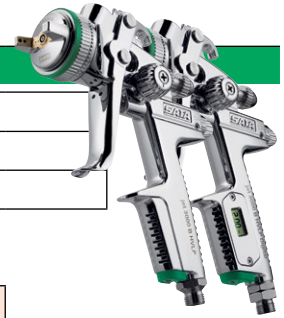

Nozzle	1.0	1.2	WSB	1.3	1.4	1.5	1.7	1.9	2.2
---------------	-----	-----	-----	-----	-----	-----	-----	-----	-----

Nozzle Set

Order No.	132910	132928	132993	132936	132944	132951	132969	132977	132985
------------------	--------	--------	--------	--------	--------	--------	--------	--------	--------

Spray Gun No Longer in Production • Replacement Parts Available

Spare Parts SATAjet® 3000 B

Order No./Desc.	
240	Packing, air piston
901	Wrench, universal spanner
1503	Screw, fan control
3426	Circlip only, 1 each
3509	Brush, large standard
3624	Pin, air micrometer
3699	Pin, lower trigger
3988	Sieve, pk of 20
3988-5	Sieve, pk of 5
6395	Disc, CC (standard), pk of 4
6585	Insert, aluminum cup
7757	Disc, CC (DIGITAL), pk of 4
9050	Tool kit
9647	Allen wrench, 4
12591	Pin, upper trigger
14605	Bushing, needle packing
14993	Spring, needle packing
15438	Kit, needle packing
17525	Spring, spacer lock
17897	Spring, paint needle
23275	Packing, needle
38638	Ring, air distribution, each
38638-3	Ring, air distribution, pk of 3
38638-5	Ring, air distribution, pk of 5
38638-20	Ring, air distribution, pk of 20
43638	Puller, wire air ring
64543	Allen wrench, 2
69872	O ring, fan control, (large)
82552	Kit, air piston service
86843	Piston, air rod
89771	Fluid Control, w/"O" ring
89805	Air cap snap ring
96875	Inner cup seal
123042	Identification ring, RP blue
123059	Identification ring, HVLP green
131623	O ring, fan control, (small)
133462	RP air cap ring w/ seal
133470	HVLP air cap ring w/ seal
133835	Repair kit, complete
133850	Kit, trigger service complete
133884	Kit, battery, cover w/gasket
133926	Kit, trigger sleeve
215806	Spring, air piston

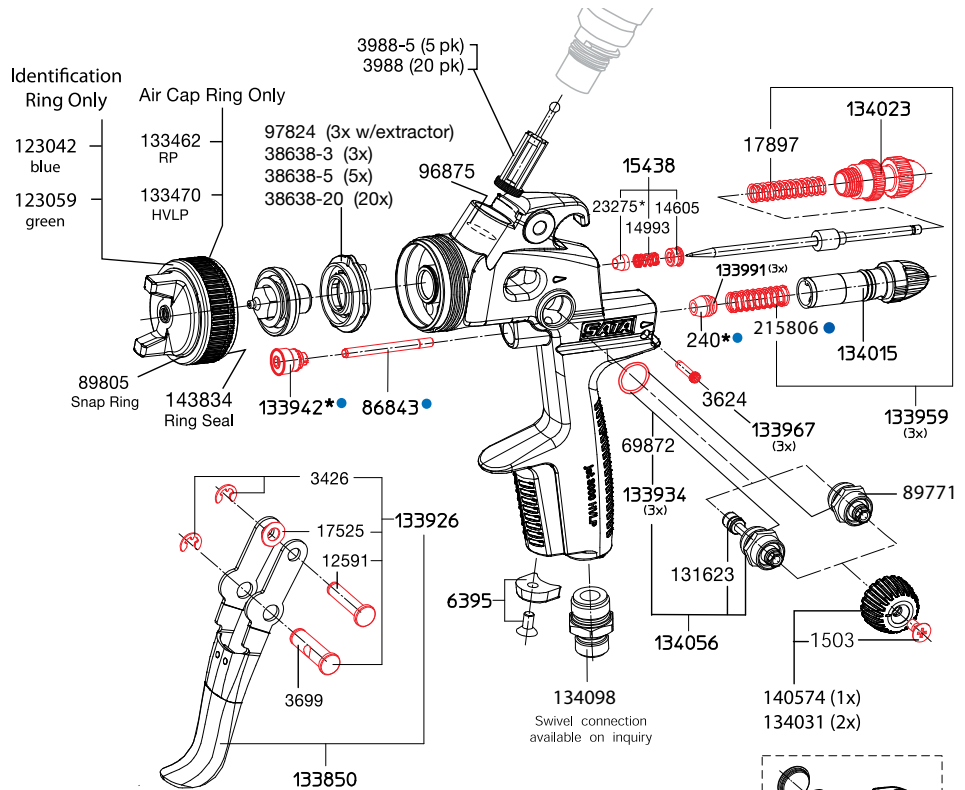

Order No./Desc.	
133934	O ring, fan control, 3 pk (large)
133942	Bushing, air piston
133959	Kit, spring, pk of 3 each of #215806 & #17897
133967	Pin, air micrometer, pk of 3
133991	Packing, air piston, pk of 3
134015	Air micrometer
134023	Kit, fluid control and lock nut
134049	Kit, left hand fan control
134056	Control, RH fan w/ O-ring
134098	Fitting, standard ? air inlet
136960	Packing kit
140574	Knob, fan control w/screw
143834	Seal, air cap ring

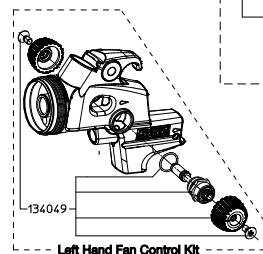
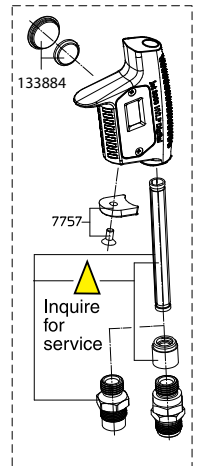

For optional left hand control spray gun only, body machined all the way through.

9050 Tool Kit	
901	Universal spanner wrench
3509	Cleaning brush
9647	Allen wrench 4mm
64543	Allen wrench 2mm
43638	Extraction tool

Order No./Desc.
133835
Repair kit
82552
Air piston service set
* 136960
Packing set

Technical modifications and printing errors reserved

SATAjet® 2000 B HVLP & SATAjet B RP

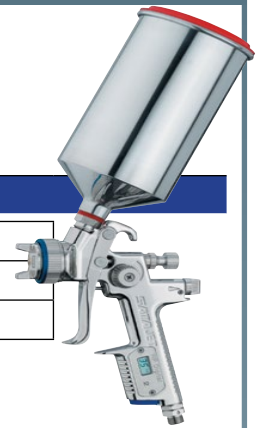

SATAjet 2000 B RP

Technical Data	Inlet Pressure: 2.0 - 2.2 bar / 29-35 psi
	Air consumption: 2.0 bar: 285 NI/min / 10.4 cfm at 29 psi
	Spray distance: 12 - 21 cm / 6 3/4 in - 8 1/4 in

Nozzle	1.0	1.2	1.3	1.4	1.6	1.8	2.0	2.5
---------------	-----	-----	-----	-----	-----	-----	-----	-----

Nozzle Set Only									
Order No.	29587	14902	14910	14936	14977	97998	69880	69898	



SATAjet 2000 B HVLP (DIGITAL)

Technical Data	Inlet Pressure: 2.0 bar / 29 psi
	Air consumption: 2.0 bar: 430 NI/min / 15.2 cfm at 29 psi
	Spray distance: 13 - 17 cm / 5 in - 6 3/4 in in

Nozzle	1.0	1.2	WSB	1.3	1.4	1.5	1.7	1.9	2.2
---------------	-----	-----	-----	-----	-----	-----	-----	-----	-----

Nozzle Set Only									
Order No.	82024	82057	9191	82073	82263	82420	90399	90407	90415

Spray Gun No Longer in Production • Replacement Parts Available

Spare Parts SATAjet® 2000 B

Order No./Desc.	
240	Air piston packing
901	Universal spanner wrench
1503	Fan control screw
1826	Non-drip device, pk of 4
3426	Circlip, pin
3509	Standard cleaning brush
3624	Pin, micrometer
3657	Knob, fan control
3699	Pin, lower trigger
3988	Paint sieve, pk of 20
3988-5	Paint sieve, pk of 5
6007	Std cleaning brush, pk of 10
6213	Trigger service set, Jet 2000, RP
6585	Insert for Alu cup adapter
7757	Color Code disc, pk of 4
9050	Tool set, Jet 2000, RP
9647	Allen wrench, 4
10033	Air cap ring w/seal, Jet RP
12591	Pin, upper trigger
14605	Bushing, needle packing
14985	Battery kit, digital
14993	Spring, needle packing
15438	Needle packing service set
17525	Lock spring
17897	Needle spring
23275	Needle packing
26518	Fluid control service set
27243	0.6L plastic cup QCC
38638	Air ring, SATAjet 2000, SATAjet RP Digital & Std. (above S/N 43,700)
38638-3	Air ring, pack of 3
38638-5	Air ring, pack of 5
38638-20	Air ring, pack of 20
43174	Air cap ring w/seal, Jet 2000
43638	Wire tool, air ring
49395	0.6 liter cup lid
49437	Cup Lid Drip Ring, 0.6L, Pk of 5
50146	Fluid regulating control
50542	Lock nut, fluid control
53603	Air micrometer
55244	Packing set: Jet 2000, RP, 90
57620	Repair kit, Jet 2000, RP
64543	Allen wrench, 2
69872	Control O-ring
71555	Plastic lid, pk of 3
82552	Air piston service set
82636	Air piston packing holder
86843	Air piston
89391	Trigger
89771	Fan Control
89805	Snap ring (air cap)
95091	Air inlet fitting, DIGITAL 
96644	Cup nipple, alum. QCC only
96685	1.0L alum. cup, QCC
96693	Red ring, alum. QCC only
96719	QCC adapter, PPS cup
96875	Inner cup seal
134098	Air inlet fitting, std. gun
143834	Seal, air cap ring, 5 pk
215806	Spring, air piston

SATAjet 2000 B Serial No. 200,000 and up Rear Mounted Needle Packing

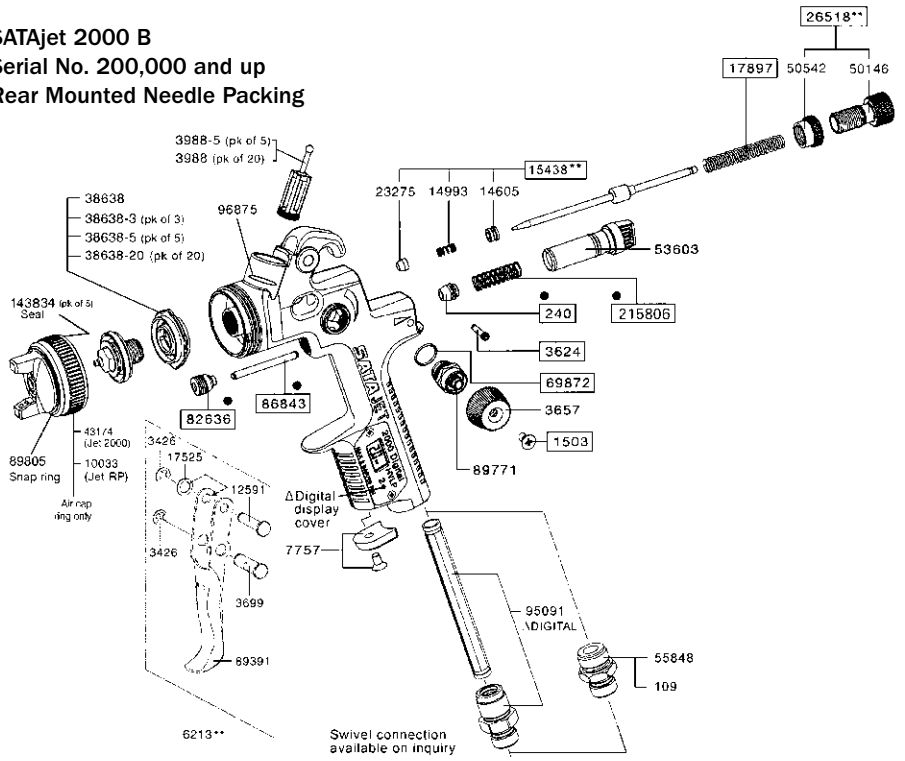

SATAjet 2000 B Serial No. 200,000 and down Front Mount Needle Packing

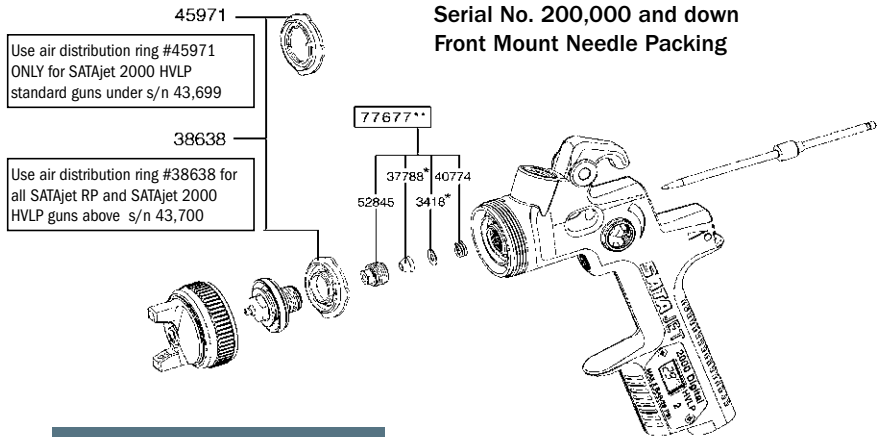

Front Mount Needle Packing Only

Order No./Desc.

901	Universal spanner wrench
3418	Packing washer
3509	Std cleaning brush
3756	Deep socket wrench
6007	Std cleaning brush, pk of 10
9654	Tool set, Jet 2000, RP
37788	Packing seal
38638	Air distribution ring, All Satajet RP's and Satajet HVLP above sn: 43,700
40774	Needle packing spring
45971	Air distribution ring Std HVLP below sn: 43,700
52845	Needle packing holder
64543	Allen wrench, 2
71431	Allen wrench, 4
77677	Needle packing service set

Order No./Desc.

<input type="checkbox"/>	57620 Repair kit
<input checked="" type="checkbox"/>	82552 Air piston service set
*	55244 Packing set
**	Parts that are available separately from Packing set

9050 Tool Kit

901	Universal spanner wrench
3509	Cleaning brush
9647	Allen wrench 4mm
64543	Allen wrench 2mm
43638	Extraction tool





SATAmijet® 3000 B HVLP

SATAmijet 3000 B HVLP

Technical Data	Inlet pressure: 29 psi
	Air consumption: 4.1 cfm at 29 psi
	Spray distance: 5-6 in

OUT OF PRODUCTION - CALL FOR AVAILABILITY - SOME STILL IN STOCK

Nozzle	0.3	0.5	0.8	1.0	1.1	0.8 SR	1.0 SR	1.2 SR	1.4 SR
---------------	-----	-----	-----	-----	-----	--------	--------	--------	--------

SATAmijet 3000 B HVLP with 0.125 l PVC cup

Order No.	125633	125641	125658	125666	125674	125724	125732	125740	125757
------------------	--------	--------	--------	--------	--------	--------	--------	--------	--------

SATAmijet 3000 B HVLP with 0.150 l aluminum cup

Order No.	125633-15	125641-15	128512	128520	128538	128488	128496	125765	128504
------------------	-----------	-----------	--------	--------	--------	--------	--------	--------	--------

SATAmijet 3000 B HVLP with 0.30 l PVC cup

Order No.						125724-3	125732-3	125740-3	125757-3
------------------	--	--	--	--	--	----------	----------	----------	----------

Nozzle	0.3	0.5	0.8	1.0	1.1	0.8 SR	1.0 SR	1.2 SR	1.4 SR
---------------	-----	-----	-----	-----	-----	--------	--------	--------	--------

Nozzle Set Standard

Order No.	125583	125591	125609	125617	125625	125682	125690	125708	125716
------------------	--------	--------	--------	--------	--------	--------	--------	--------	--------

Special Versions

125773	SATAmijet 3000 HVLP design set with air hose, glass cups, plastic cup, adapters and micrometer - specify nozzle at time of order Specify nozzle size or will be shipped with 1.0 nozzle			
127829	SATAmijet 3000 B T HVLP. Pressure fed conversion of a SATAmijet to allow optimal material flow - specify nozzle at time of order Specify nozzle size or will be shipped with 0.3 nozzle			
670284	SATAmijet 3000 B T HVLP Combo, includes 2L Dan-Am pressure pot and 0.125L PVC cup to convert from pressure fed to gravity fed, dual hose Specify nozzle size or will be shipped with 0.8SR nozzle			

Spray pattern comparison

SATAmijet 3000 B HVLP 1.0 (29 psi) for standard applications	SATAmijet 3000 B HVLP 1.0 SR (29 psi) for spot repair applications
	<ul style="list-style-type: none"> • Lowers risk of creating bright edges • Allows painter to apply thin layers of paint

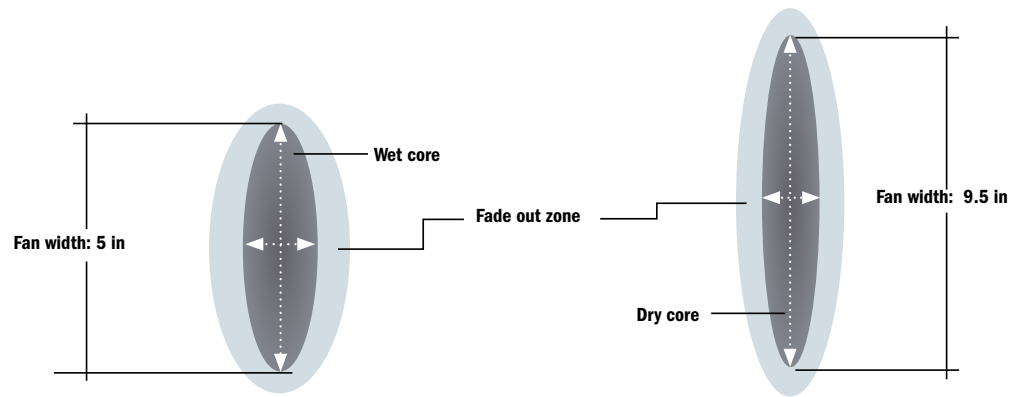

Spare Parts SATAmijet® 3000 B HVLP

Order No./Desc.	
901	Universal spanner wrench
3509	Standard cleaning brush
6007	Standard brush, pk of 10
6395	ColorCode discs, pk of 4
15925	Spanner wrench, small
16295	Glass cup w/plug-in lid
22566	Pin, upper trigger
26583	Circlip
35600	Cup Seal
44644	Lock nut
44669	Spring, needle
44677	Pin, lower trigger
44735	Screw, fan control
44818	Spring, air piston
44826	Packing, air piston
44834	Air piston
44842	Bushing, needle packing
44859	Packing, needle
50658	Packing set, minijet
53033	Set of 5 glass plug-in cups
58164	Set of 5 glass cups w/lid
62810	Piston packing
64022	.150 L cup lid, pk of 3
64022-10	.150 L cup lid, pk of 10
64972	Air micrometer pin
68809	Spring, needle packing
74351	Gasket, air hose
79905	Needle packing service set
95448	.125 L lid w/drip proof vent
95489	Anti-drip device, pk of 4
124164	Knob, fan control
124271	Air distribution ring
124768	Air cap ring w/seal
125112	Snap ring (air cap ring)
125146	Knob, fluid control
125187	Air micrometer
125344	Fan control, O Ring, small
125351	Fan control
125377	Bushing, air piston
125443	.125 L QCC plastic cup w/lid
125492	Trigger
125856	Tool set
125948	.150 L QCC alum. cup w/lid
125955	Adapter, plug-in cup (QCC)
125963	Quick color change set 5 cups, 2 funnels, adapter
126037	Washer, tension spring
126276	Trigger service set
131037	Fan control, O Ring, large

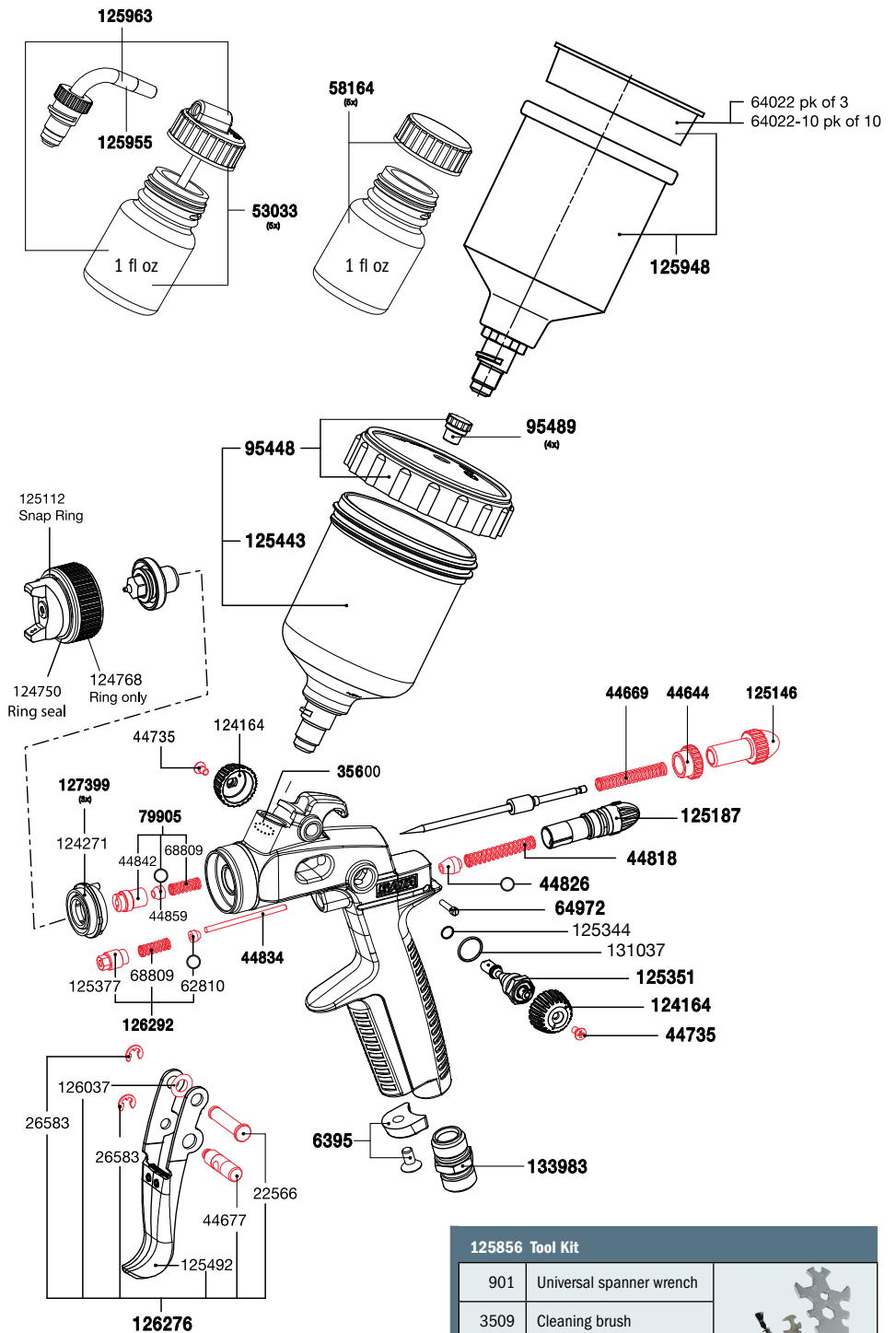

Order No./Desc.	
126284	Repair kit, minijet 3000 B, minijet 4
126292	Air piston service set
127399	Air distribution ring, pk of 3
129346	QCC adapter for PPS cup
131037	Fan control, O Ring, large
133983	Air inlet fitting, 1/4 BSP

125856 Tool Kit	
901	Universal spanner wrench
3509	Cleaning brush
15925	Wrench, multi
43638	Extraction tool

Order No./Desc.	
<input checked="" type="checkbox"/> 126284	Repair kit
<input type="checkbox"/> 50658	Sealing kit

Technical modifications and printing errors reserved

SATAjet® KLC RP®/HVLP

SATAjet® KLC P

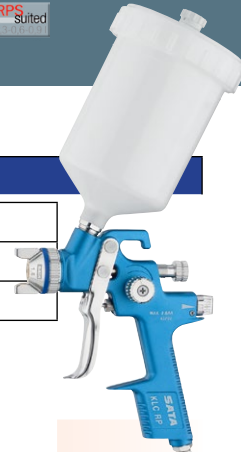

SATAjet KLC RP						
Technical Data		Inlet pressure: 1.5 - 2.0 bar / 7-29 psi				
		Air consumption: 2.0 bar: 290 NI/min / 10.2 cfm @ 29 psi				
		Spray distance: 18-23 cm / 5-7 in				
Nozzle	1.3	1.6	1.6NA	1.8	2.0	
Nozzle Set						
Order No.	87973	87981	88005	96768	87999	

SATAjet KLC P		
Technical Data		Inlet pressure: 1.5 - 2.0 bar / 29 psi
		Air consumption: 2.0 bar: 245 NI/min / 8.7 cfm @ 29 psi
		Spray distance: 18-23 cm / 5-7 in
Nozzle	P	
Nozzle Set		
Order No.	88013	

SATAjet KLC HVLP					
Technical Data		Inlet pressure: 2.0 bar / 29 psi			
		Air consumption: 2.0 bar: 350 NI/min / 12.4 cfm @ 36 psi			
		Spray distance: 18-23 cm / 5-7 in			
Nozzle	1.4	1.7	1.9	2.1	
Nozzle Set					
Order No.	32748	32755	32771	33415	

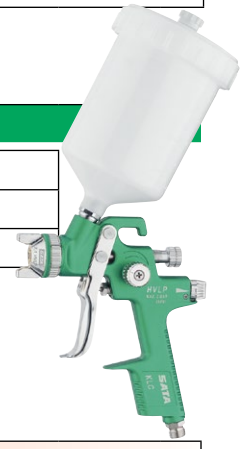

Spray Gun No Longer in Production • Replacement Parts Available

Spare Parts SATAjet® KLC

Order No./Desc.
109
Air inlet fitting
240
Air piston packing
422
Air piston packing
1503
Countersunk screw M4 x 8 DIN 965, stainless steel, for micrometer and round/flat control
3426
Circlip pin
3624
Pin, air micrometer
3699
Lower trigger pin
3749
Air piston packing holder
6486
Trigger service set
12591
Upper trigger pin
14605
Needle packing bushing
14993
Needle packing spring
15438
Paint needle packing
17525
Lock spring
20396
Air distribution ring (1x)
29629
Air piston
53603
Air micrometer
54221
Fan control
55137
Trigger
62513
Air distribution insert
65557
Fan control knob
83758
Fluid regulating control
133926
Trigger sleeve kit
133934
pk of 3 packings
133959
Spring set: 3 x #17152 & 3 x 10520
134601
Air distribution ring (3x)
215806
Spring, air piston

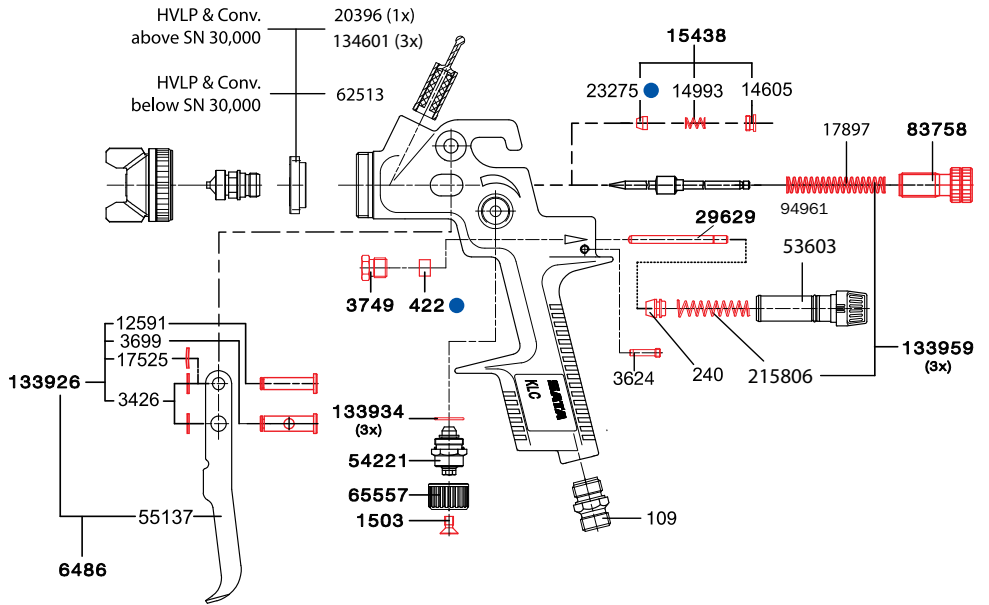

9944 HVLP, 9050 Conv, Tool Kit	
901	Universal spanner wrench
3509	Cleaning brush
9647	Allen wrench 4mm
43638	Extraction tool
64543	Allen wrench 2mm



Order No./Desc.
57620
Repair kit
54080
Packing set

Technical modifications and printing errors reserved

SATAjet® B (SATAjet® GR)

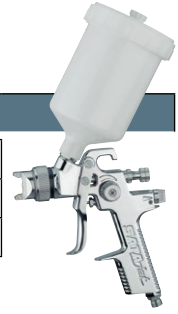

SATAjet B

Technical Data	Inlet pressure: 58 psi
	Air consumption: 12 cfm at 60 psi
	Spray distance: 5-7 in

Nozzle	1.0	1.3 (MSB)	1.4	1.5	1.7	2.0
---------------	-----	-----------	-----	-----	-----	-----

Nozzle Set Only

Order No.	4143	4127	3848	4119	4101	4093
------------------	------	------	------	------	------	------

SATAjet GR

Technical Data	Inlet pressure: 58 psi
	Air consumption: 12 cfm at 60 psi
	Spray distance: 5-7 in

Nozzle	1.3 W	1.5 W	1.7 W	2.0 W	2.5 W	3.0 W
---------------	-------	-------	-------	-------	-------	-------

Nozzle Set Only

Order No.	31252	31898	31997	4093	13003	13011
------------------	-------	-------	-------	------	-------	-------

Spray Gun No Longer in Production • Replacement Parts Available

Spare Parts SATAjet® B (SATAjet® GR)

Order No./Desc.
422
Air piston packing
1503
Countersunk screw M4 x 8 DIN 965, stainless steel, for micrometer and round/flat control
1826
Non-drip device for 0.6 l PVC cup, pk of 4
2600
Service set for nozzle insert consisting of nozzle insert, distribution plate and sealing ring
3566
Fluid inlet nipple, SATAjet B
3657
Knob, Fan Control
3749
Air Piston Packing Holder
3988
Paint strainer for SATA standard sized spray guns (20x)
3988-5
Paint strainer for SATA standard sized spray guns (5x)
6445
Needle packing set
6486
Trigger service set
16162
Swivel joint for SATA DIGITAL spray guns
29629
Air piston
49379
Plastic gravity cup 0.6 l with lid and female fittings
49395
Screw on lid for 0.6 l PVC cup with drip-catching ring and non-drip device
54221
Fan control
61416
Paint flow control screw cpl. w/ counter nut
64766
Spacer ring
133926
Trigger sleeve kit
133934
pk of 3 packings
133959
Spring set: 3 x #17152 & 3 x 10520
133967
pk of 3 adjustment screws
133983
Air connection piece G1/4a
133991
pk of 3 air piston heads

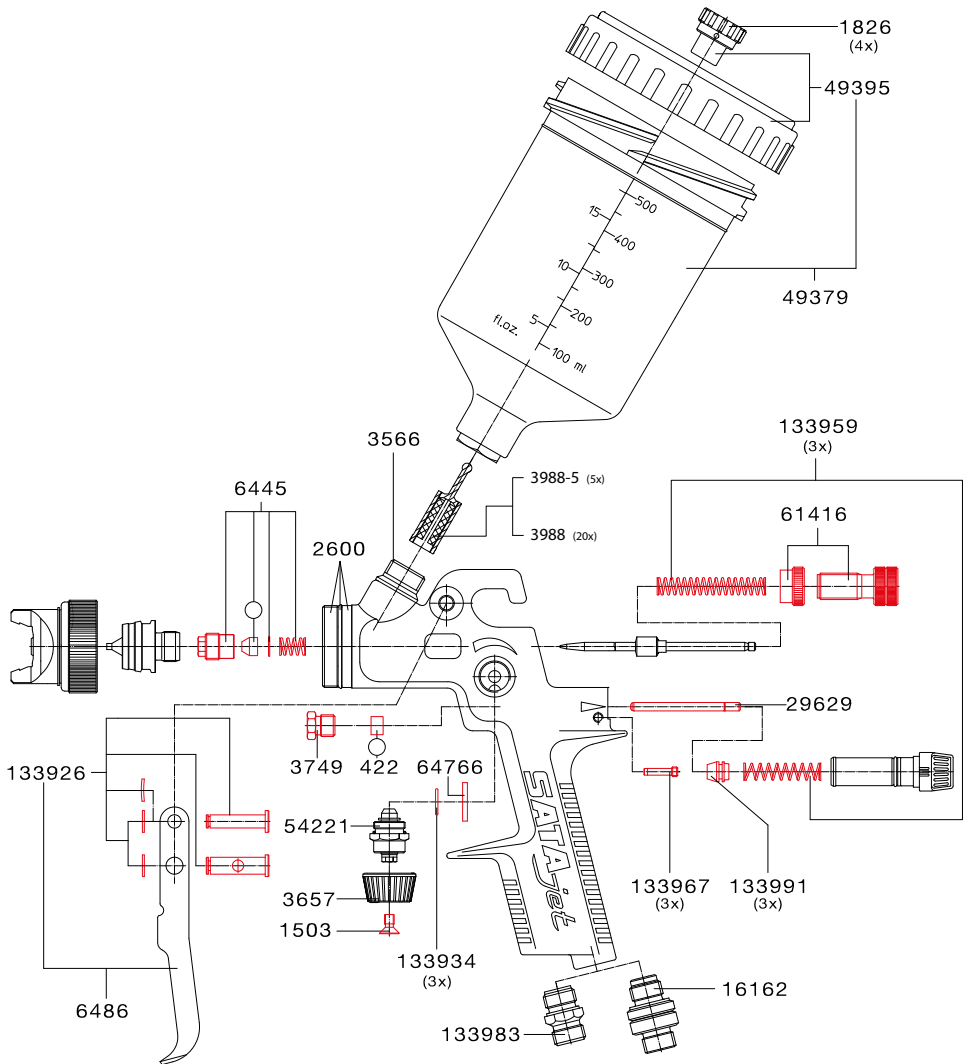

Technical modifications and printing errors reserved

9654 Tool Kit	
901	Universal spanner wrench
3509	Cleaning brush
64543	Allen wrench 2mm
71431	Allen wrench 4mm
76307	Socket wrench



Order No./Desc.
69666
Repair kit from S/N 650000 on
9829
Packing set







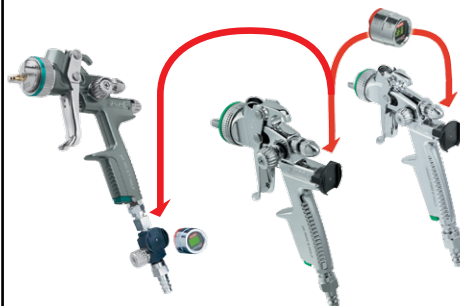

Accessories for Spray Guns

Adam 2 - Accurate pressure control



The digital pressure gauge SATA adam 2 allows the exact adjustment of the spray pressure on paint spray guns with an accuracy of +/- 1 psi. Permanent spray pressure control during painting significantly contributes to perfect color matching and high quality finishes preventing costly reworks due to incorrect pressure setting.

All SATA paint spray guns with an integrated air micrometer can now be upgraded with the SATA adam 2. The assembly is very simple and quick - the standard air micrometer is replaced by the retrofit SATA adam 2 with just a few easy steps.







211557	SATA adam 2, dock and psi display for SATAjet 5000 only	
211565	SATA adam 2, dock only for SATAjet 5000 only	
211573 (2X)	Adaptor plate for the SATA adam 2 display replaces the standard air micrometer. The integrated seal provides full pressure setting functionality even when the display has been removed. Comes with protective cover when display is not mounted.	
160853	SATA adam 2, dock and psi display With the SATA adam 2 consisting of two separate components docking base and display - usage, cleaning and maintenance have become a lot easier. Fits SATA standard size spray guns, except Jet 5000	
160887	SATA adam 2 mini, psi complete Fits SATAminijet 4400 B and SATAjetminijet 1000 K along with older models, minijet 3, minijet 4, and SATAminijet 3000 B.	
160697	SATA adam 2 display only The digital readout which contains all electronic components. As the pressure is set by turning the setting wings on the docking base only, the digital display always remain in the upright position ensuring perfect pressure reading at all times. For increased safety during gun cleaning in gun washing machines, a simple, reliable click-in mechanism quickly releases the SATA adam 2 display from the dock. This mechanism also allows using the SATA adam 2 display on different SATA spray guns equipped with a docking base and the adam 2U.	
160788	SATA adam 2 dock, for standard size SATA spray guns except Jet 5000. Adaptor plate for the SATA adam 2 display replaces the standard air micrometer. Available in two versions for SATA standard guns and	
160796 (2x)	SATA minijet guns, it now also features the micrometer function for pressure setting. The integrated seal provides full pressure setting functionality even when the display has been removed. Comes with protective cover when display is not mounted.	
160861	SATA adam 2 mini dock Fits SATAminijet 4400 B and SATAjetminijet 1000 K along with older models, minijet 3, minijet 4, and SATAminijet 3000 B.	
160739	SATA adam 2 battery set	

SATA adam 2 U (digital pressure gauge)

195222	SATA adam 2 U for precise measure of air pressure Air micrometer with dock and display	
195230	SATA adam 2 U dock only Air micrometer G 1/4 with SATA dock	
195925	SATA adam 2 U dock only, G 1/8 male thread, (can also be used use to replace analog gauge on a #27771 to a digital U2 or analog gauge on a SATA filter, 400 series) with an adapter	

Technical modifications and printing errors reserved

Accessories for Spray Guns

Air Micrometer and Pressure Gauges		
27771	<p>SATA Air Micrometer with Gauge</p> <p>This high quality air micrometer indicates air pressure settings at the spray gun air inlet. The gauge bezel has a green color coded pressure range for correct adjustment of SATA HVLP guns and blue for SATA RP (reduced pressure) guns. The SATA air micrometer with gauge housing is anodized black and adjustable from 0 - 145 psi.</p>	
4002	<p>SATA In-Line Hose Pressure Gauge</p> <p>High-volume in-line pressure gauge with unrestricted airflow to the spray gun (non-adjustable). HVLP and RP color-coded pressure gauge face with a high flow coupler and nipple.</p>	
43786	<p>SATA line pressure gauge</p> <p>It also works well with spray guns without the built-in air micrometer feature or when air pressure is not critical. Rugged metal black anodized housing. Connects to 1/4 BSP</p>	
123513	<p>SATA Replacement Gauge for above micrometer only</p>	

Air Micrometer		
9860	<p>SATA air micrometer only without gauge</p> <p>It also works well with spray guns without the built-in air micrometer feature or when air pressure is not critical. Rugged metal black anodized housing. Connects to 1/4 BSP air inlet fitting. No access port for gauge.</p>	

Spare Parts SATA® adam 2

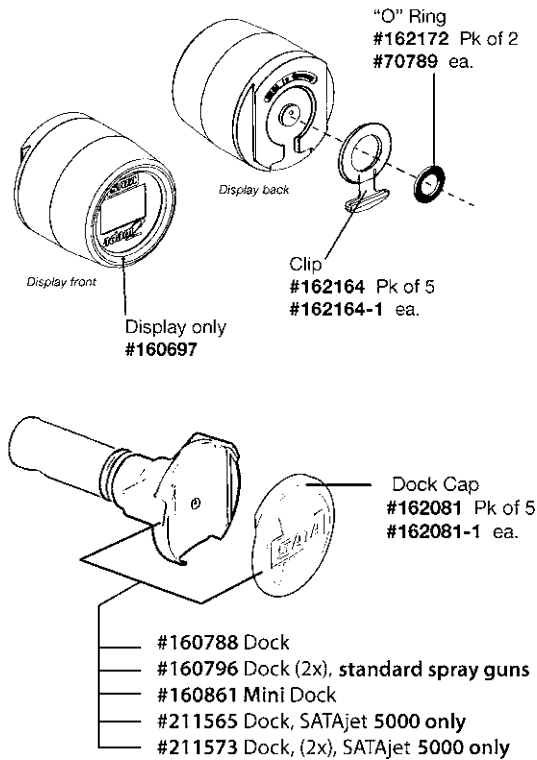

Battery replacement kit
Part No. 160739









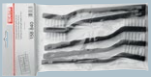

Technical modifications and printing errors reserved

Accessories for Spray Guns

Pressure measurement and adjustment		
Air connection		
13656	SATA HVLP female nipple G 1/4 female thread (use 6981 for 5-pk)	
53942	SATA HVLP male nipple G 1/4 male thread	
13599	SATA HVLP female QC G 1/4 female thread	
13623	SATA HVLP male QC G 1/4 male thread	
99895	Universal swivel fitting - flexible connection nipple G 1/4	
Spray Gun Holders		
192195	SATA spray gun and hose holder	
9886	SATA gravity gun holder	
40188	SATA bench mounted gun holder	
69328	Spray gun stand, complete, for SATAminijet 3000 B HVLP and SATAjet 20 B Can be used for gravity or side cups	
9898-3	3 gun wall mount, gravity feed spray guns	
9898-3A	3 gun wall mount or cabinet add-on, gravity feed spray guns	
9898-4	4 gun wall mount, gravity feed spray guns	
9898-6	6 gun wall mount (3 x 2), gravity feed spray guns	
9890-M	Dan-Am SATAminijet hanger, wall mount or cabinet mount	
Cleaning and maintenance		
60095	SATAClean, 3 gun soaking tray	
60111	Plug-set (3-pieces) for SATA Clean	
162628	SATA care set, spray gun care bag with cleaning utensils and spray gun grease. Scope of supply: 1x Large cleaning brush, 5x medium cleaning brush, 5x double ended cleaning brush, 12x nozzle cleaning needles, 1x high performance SATA grease (100 ml)	
48173	100 g tube SATA high performance grease for spray guns, silicone and acid free	
3988-5	5-pk paint strainer for SATA reusable cups	
3988	20-pk paint strainer for SATA reusable cups	
9894	SATA nozzle cleaning needles, pk of 12	
64030	Cleaning set: 2x cleaning brushes & 12x nozzle cleaning needles	

Technical modifications and printing errors reserved





Accessories for Spray Guns

Cleaning and maintenance		
3509	Cleaning brushes, each	
6007	Cleaning brushes, pk of 10	
64220	Small cleaning brushes, each	
9209	Small cleaning brushes, pack of 10	
158840	Cleaning brushes, pack of	
53496	Large SATA siphon pick-up pipe, each	
29280	Large SATA siphon pick-up tube, pack of 10	
64035	Dan-Am Spray gun maintenance kit: 13 x various sized SATA cleaning brushes, 2 x SATA cleaning broaches, 1 x gun lube (1/2 oz)	
64036	Dan-Am Air brush cleaning kit, includes; 5x mini brush set, 1x plastic handled brush, 2x double ended brushes, 2x cleaning brushes w/handle, 2x cleaning broches, 2x large brushes, 1x EZ airbrush cleaner, 1x airbrush lube oil	
9845	SATA viscosity cup 4.0 mm, machined from solid aluminum	
9852	SATA viscosity cup, extruded aluminum	
Quality control		
7096	SATA Air Check Set Compressed air testing device. Simply connect and allow air flow for 15 minutes or longer. Test paper traps dirt, oil and in-line contamination. Complete with test paper, tweezers, magnifying glass and exam light all in a compact carrying case.	
	Air check test paper	
7666-10	Test paper, pack of 10	
7666-50	Test paper, pack of 50	
7666-100	Test paper, pack of 100	
156299	SATA air tester, use to determine contaminates in airline	
161596	SATA cert, with archive, spray pattern block, single sheet holder and distance marker	
161646	Spray pattern blocks each w/ 25 sheers for SATA cert	
161661	Distance marker for SATA cert	

Technical modifications and printing errors reserved

Continued on page 66

Accessories for Spray Guns

Cleaning and maintenance		
Other accessories		
59675	SATA dosenboy, to cut out can lids from cans up to 36 cm height	
165506	Air cap protectors (red) for SATAjet 3000 B, K, SATAjet 2000, all K3's and LP90, 5 pack	
165514	Air cap protectors (red) for SATAjet 100 B and SATAjet 1000 B, SATAjet 4000 & 5000 B, 5 pack	
165522	Air cap protectors (red) for SATAminijet 3000, SATAminijet 1000 K, 5 pack	
139444	Air cap protector (black) for UV materials, (not shown), SATAjet 2000, 3000 & K3, 5 pack	
203331	Air cap protectors (red) for SATAminijet 4400 B, 5 pack	
TP-90S TP-90S5	SATAjet 90, each SATAjet 90, 5 pack	
TP-MC TP-MC5	SATA KLC, MC-B, LM 2000, LM-92, each SATA KLC, MC-B, LM 2000, LM-92, pack of 5	
TP-MINI TP-MINI5	SATAminijet, minijet 2, minijet 3, each SATAminijet, minijet 2, minijet 3, pack of 5	
TP-INLET TP-INLET5	Dan-Am inlet protector, each Dan-Am inlet protector, pack of 5	

Intermediate cleaning with SATA cleanRCS



1 Clean and rinse material passage and air cap



2 Blow dry spray gun and material passage

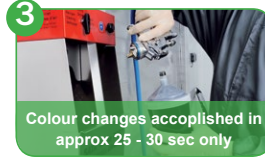

3 Colour changes accomplished in approx 25 - 30 sec only

Cleaning with gun washing machine SATA multi clean 2

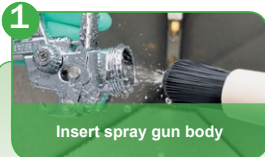

1 Insert spray gun body



2 Connect air connection to air inlet

Please ensure that the spray gun is always placed in the correct position inside the washing chamber of self-contained washing machines. **Make sure that no cleaning agent penetrated the air passages of the spray gun.**

Important Note

It is **essential** to observe the **pH value** of your cleaning agent!

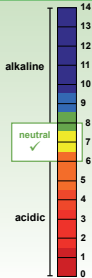

The **pH value** should be ranging **between 6 - 8!**

Cleaning Accessories



Order No. 158840

5 cleaning brushes, large for cleaning the outside of the gun body



Order No. 6007

10 cleaning brushes, medium size for fluid tip and material passages of gun



Order No. 9209

10 double-sided cleaning brushes for cleaning air caps and fluid tips



Order No. 9894

12 nozzle cleaning needles for cleaning front apertures of air cap and fluid tip



Order No. 48173

High performance grease, 100 ml, silicone and acid free for all moving parts of the gun



Order No. 64030

Cleaning kit consisting of 2 cleaning brushes and 12 cleaning needles



Order No. 162628

SATA care set - bag containing tools for spray gun cleaning and maintenance. Offers extra pockets for additional maintenance tools.

Scope of supply:

- 1x Cleaning brush, large ①
- 5x Cleaning brushes, medium ②
- 5x Cleaning brushes, double-sided ③
- 12x Nozzle cleaning needles ④
- 1x high performance grease, 100 ml ⑤

Please make sure that all brushes being used **have no protruding metal wires** as these may damage the spray gun. Please exclusively use recommended tools for cleaning only.

We recommend leaving the spray gun connected to the **air circuit with reduced pressure** even for manual cleaning. Make sure that cleaning agent never enters the air passages of the spray gun.

Disassembly of nozzle set



1 First remove the paint needle

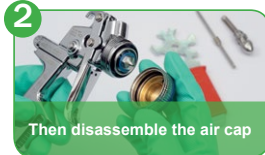

2 Then disassemble the air cap

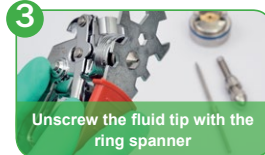

3 Unscrew the fluid tip with the ring spanner

Cleaning and drying of the spray gun...



1 Clean the material passage

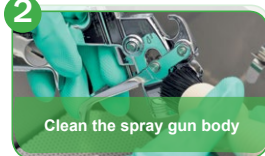

2 Clean the spray gun body



3 Dry with blow gun

... and the nozzle set

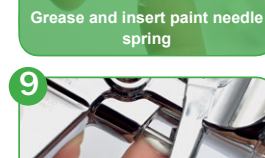
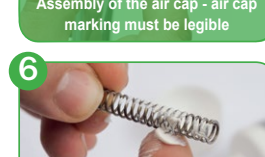
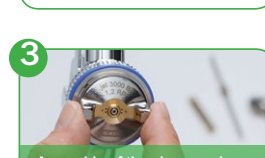
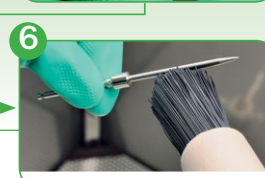
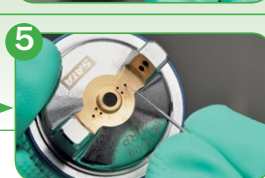
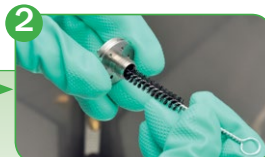
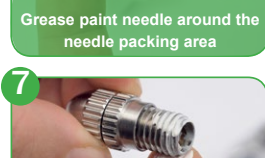

Assembly and Maintenance

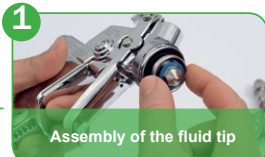

1 Assembly of the fluid tip

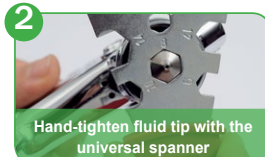

2 Hand-tighten fluid tip with the universal spanner



3 Assembly of the air cap - air cap marking must be legible



4 Grease paint needle around the needle packing area



5 Insert paint needle

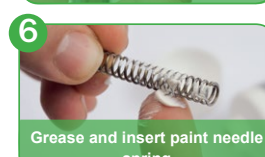

6 Grease and insert paint needle spring



7 Grease thread of material flow control screw



8 Install material flow control screw

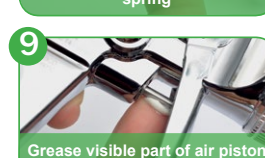

9 Grease visible part of air piston rod

Final blow dry before painting



Before painting, connect the air hose and blow air to be sure all passages are dry. With air connected and trigger pulled, move the air micrometer and fan control knobs back and forth to force air in and out of all air passages to empty them completely of solvent or water. Put gun away dry, do not soak the air cap.

Please watch our video at www.sata.com/TV concerning **Cleaning and Maintenance of Spray Guns**. Or simply request our brochure for thorough guidelines.



Viscosity Cup Conversion Chart - SATA Din 4

SATA DIN 4	POISE	CENTIPOISE	DUPONT PARLIN 7	DUPONT PARLIN 10	FISHER 1	FISHER 2	FORD CUP 3	FORD CUP 4	KREBS UNITS KU	SAYBOLT UNIVERSAL SSU	ZAHN 1	ZAHN 2	ZAHN 3	ZAHN 4	ZAHN 5	SATA DIN 4
9	0.1	10	27	11	20					50	30	16				9
11	0.15	15	30	12	25					80	34	17				11
12	0.2	20	32	13	30	15	12	10		100	37	18				12
15	0.25	25	37	14	35	17	15	12		130	41	19				15
17	0.3	30	43	15	39	18	19	15		160	44	20				17
18	0.4	40	50	16	50	21	25	17		210	52	22				18
20	0.5	50	57	17		24	29	19	30	260	60	24				20
22	0.6	60	64	18		29	33	21	33	320	68	27				22
23	0.7	70		20		33	36	23	35	370		30				23
24	0.8	80		22		39	41	26	37	430		34				24
28	0.9	90		23		44	45	29	38	480		37	10			28
30	1.0	100		25		50	50	31	40	530		41	12	10		30
32	1.2	120		30		62	58	36	43	580		49	14	11		32
39	1.4	140		32			66	41	46	690		58	16	13		39
42	1.6	160		37				45	48	790		66	18	14		42
46	1.8	180		41				51	50	900		74	20	16		46
50	2.0	200		45				56	52	1000		82	23	17	10	50
55	2.2	220						61	54	1100			25	18	11	55
59	2.4	240						67	56	1200			30	21	13	59
64	2.6	260						72	58	1280			32	22	14	64
67	2.8	280						76	59	1380			34	24	15	67
70	3.0	300							60	1475			36	25	16	70
74	3.2	320								1530			39	26	17	74
79	3.4	340								1630						79
83	3.6	360							62	1730			41	28	18	83
86	3.8	380								1850			43	29	19	86
89	4.0	400							64	1950			46	30	20	89
94	4.2	420								2050			48	32	21	94
100	4.4	440								2160			50	33	22	100
105	4.6	460							66	2270			52	34	23	105
110	4.8	480							67	2380			54	36	24	110
122	5.0	500							68	2480			57	37	25	122
131	5.5	550							69	2660			63	40	27	131
150	6	600							71	2900			68	44	30	150
172	7	700							74	3375				51	35	172
193	8	800							77	3880				58	40	193
274	9	900							81	4300				64	45	274
	10	1000							85	4600					49	274
	11	1100							88	5200					55	

General guidelines for gravity guns using a DIN 4 viscosity cup

(use smaller nozzle sizes for pressure fed and larger for siphon feed guns)

General guidelines for nozzle size

- 1.2 for water borne
- 1.3 for basecoat, some clears with low VOC on HVLP
- 1.4 for clearcoat, single stage, surfacer, sealer, epoxy, waterborne, wash and etch primer
- 1.5 for clearcoat, single stage
- 1.6 for primer
- 1.7 for primer, filler
- 1.8 for primer, filler
- 1.9 for filler, high build
- 2.0 for filler, high build
- 2.5 for polyester



SATA Viscosity Cup

Using a viscosity cup will ensure consistent measuring of material viscosity for selecting the right nozzle size. DIN 4 (4).

Extruded Aluminum

Each **Order No. 9852**

Turned Aluminum

Each **Order No. 9845**

How to use a SATA DIN 4 viscosity cup

The DIN (German engineering standard) viscosity cup, part number 9852 is a 100ml container with a 4 orifice. To measure material viscosity, dip the cup in the material, using a stopwatch or second hand on a watch, check how many seconds it takes for the cup to empty. The clearance time is the DIN viscosity expressed in seconds. Determining the viscosity makes nozzle selection easier. Also check paint company application charts for nozzle sizes.

Test Air Cap Procedure

HVLP TEST AIR CAP



The SATA test air cap with dual gauges is a visual means of proving HVLP compliance. By fitting the with this air cap and turning the fan control through its entire range, both center and horn air cap pressure can be verified. When the recommended air inlet pressure is applied to the, the maximum air cap pressure will not be exceeded. All SATA HVLP guns are at least 65% transfer efficient and meet all HVLP legislation.

The dual test gauge is normally used for classroom or demo work. Purchasing the SATA test air cap with dual gauges may be required by local or state ordinance, and is a useful tool to check accurate pressure settings.

SATA HVLP Gun Set-Up is as simple as 1 - 2 - 3

- 1.** Use a minimum 3/8 ID air hose with non-restrictive nipples and couplings.
- 2.** Use the SATA adam2 digital air micrometer, SATA adam 2 U (Universal digital pressure gauge), SATA air micrometer with gauge #27771 or the SATA line pressure gauge #43786, for accurate pressure Setting.
For DIGITAL Sata guns use built in digital air micrometer.
- 3.** Set the recommended inlet air pressure with the trigger pulled and the built-in air micrometer (control at rear of gun), set to the 12:00 o'clock position. You're ready to shoot after setting fluid and fan control.

SATA HVLP's are internally engineered to do the rest. The Venturi principle (air converter) automatically reduces recommended inlet air pressure to the maximum 10 psi allowed. SATA HVLP nozzle sets are engineered for fine atomization and high performance at low air pressure.

SATA Calculator Available

@ www.satausa.com

Services > Paint Advisor > Calculator

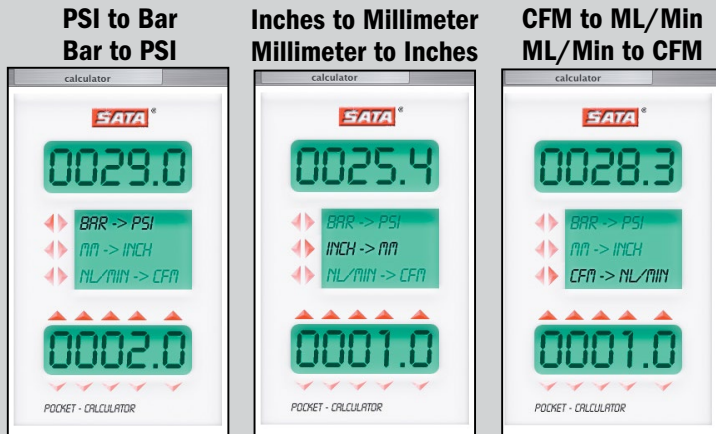

SATA calculator has six conversions.

Metric to Decimal Conversion Chart

0.15mm = .0059	1.0mm = .0394	1.9mm = .0748
0.2mm = .0078	1.1mm = .0433	2.0mm = .0787
0.25mm = .0098	1.2mm = .0472	2.1mm = .0827
0.35mm = .0138	1.3mm = .0512	2.2mm = .0866
0.5mm = .0197	1.4mm = .0551	2.3mm = .0906
0.6mm = .0236	1.5mm = .0591	2.4mm = .0945
0.7mm = .0276	1.6mm = .0630	2.5mm = .0984
0.8mm = .0315	1.7mm = .0669	3.0mm = .1181
0.9mm = .0354	1.8mm = .0709	5.0mm = .1969

Approximately 28.3 l/min = 1 cfm.	Approximately 1 Bar = 14.5 psi	DIN 4 Viscosity Cup Orifice 4mm = .1575
---	--------------------------------------	---

0.9463 liter = 1 qt	.03 liter = 1 oz.	2.54 cm = 1 inch	1 meter = 39.37 inches
------------------------	----------------------	---------------------	---------------------------

8 oz = 1 cup	16 oz = 1 pint	32 oz = 1 quart	128 oz = 1 gallon
-----------------	-------------------	--------------------	----------------------

Helpful Tips for Top Quality Paint Jobs

Spray pattern

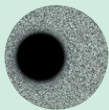

Round spray uneven



Sickle spray pattern



Deformed spray pattern on one side



Split fan
(swallow-tail)



Material deposit too heavy in
fan pattern



Irregular or fluttering fan pattern

Cause and remedy

Middle air cap air passage dirty or deformed

Clean thoroughly or replace nozzle set if required

Air cap horn dirty or deformed

Clean horn air passages or replace nozzle set

Dirty or deformed holes in air cap horns

**Clean nozzle with special cleaning kit
or replace nozzle set**

Too much thinner in material

**Spray pressure too high
Fan width too wide**

Atomization pressure too low – **increase pressure**

Viscosity too high – **add thinner to material**

Too much material – **use smaller nozzle set**

Fluid tip or needle loose – **tighten parts**

Paint cup plugged – **clean air vent hole** (lid vent)

Air distribution ring – **replace**

Automatic & Robotic Spray Guns







German Engineering

Spray Guns | Breathing Protection | Air Filtration | Accessories







Selection guide for Auto and ROB spray guns

		SATAJet® 3000 A		SATAJet® 3000 ROB		SATAJet® 1000 A		SATAmijet® 1000 A		
										
PERFORMANCE FEATURES	Atomization technology (RP/HVLP)	HVLP	RP	HVLP	RP	RP	HVLP	RP		
	Internal control	■	■	--	--	■	■	■		
	External control	--	--	■	■	--	--	--		
	*Spray fan width in cm	22 - 34	22 - 40	31 - 33	22 - 40	24 - 37	16 - 27	13 - 27		
	* Material flow in g/min	150 - 700	100 - 900	300 - 400	400 - 500	150 - 1000	60 - 170	60 - 250		
	** Air consumption in NI/min at 2.5 bar	450	400	450	450	440	170	195		
	Material circulation	■	■	■	■	■	■	■		
	Optional: Extensions	--	--	--	--	■	--	--		
FIELDS OF APPLICATION	Externally controlled robotic systems	--	--	■	■	--	--	--		
	Robotic painting systems with adjustment of the spray parameters on the spray gun	■	■	--	--	■	■	■		
	Marking applications, component marking	--	--	--	--	--	--	--		
TECHNICAL DATA	Spray gun weight in g	Standard: 780 Stainless steel: 990		Standard: 490 Stainless steel: 690		Standard: 780 Stainless steel: 990		Standard: -- Stainless steel: 915		
	Spray gun length in mm	147		127		147		147		
	Width x height in mm	45 x 45		45 x 45		45 x 45		45 x 45		
	Air cap fixation	45°		45°		45°		--		
	Available nozzle sizes	HVLP: 0.5; 0.8; 1.0; 1.2; 1.6; 2.0					RP: 0.8; 1.1; 1.3; 1.5; 2.0; 3.0		HVLP: 0.3; 0.5; 0.8; 1.0; 1.2	
		RP: 0.5; 0.8; 1.1; 1.3; 1.5; 2.0							RP: 0.3; 0.5; 0.8; 1.0; 1.2	
	Standard version	■		■		■		--		
	Anodized aluminium	■		■		■		■		
Stainless steel version	■		■		■		■			
Connection thread	G 1/4		G 1/4		G 1/4		G 1/4			
Material inlet/-outlet, control air, atomization air	Female thread		Female thread		Female thread		Female thread			
Optional: Quick change adapter	A		ROB		A		A			
Selection criteria Product advantages	Coating requirements	For highest requirements in terms of brilliance, material distribution, color match precision and gloss.				Universal application requirements		Finest atomization for small surfaces		
	For the use of waterborne paint systems and materials	Optionally available as stainless steel version								
	Control/Adjustment	Manual adjustment of round and flat fan as well as material flow	Manual adjustment of round and flat fan as well as material flow		External adjustment of round and flat fan as well as material flow		Manual adjustment of round and flat fan as well as material flow			
Internally controlled Pre and Post air, i.e. no external control valve required		Internally controlled Pre and Post air, i.e. no external control valve required		Atomization air Continuous air flow		Internally controlled Pre and Post air, i.e. no external control valve required				

* **Material flow rate and fan size** are approximate values and depend on the nozzle size being used. These values have been determined using paints with a viscosity ranging between 17 and 24 sec. DIN 4, material pressure 0.6 - 0.9 bar and atomisation air pressure 3.5 - 4.5 bar (exact values have to be determined with the actual operating parameters and paint materials).

** **Air consumption** is only an approximate value and is depending on the nozzle size; pressure measured at spray gun inlet.

Selection guide for Auto and ROB spray guns

SATAMinijet® 1000 ROB		SATAMinijet® 1000 A S		SATA LPS 2000	SATAjet® 3000 A spray mix	Lab test spray guns	Gun type
							
HVLP	RP	HVLP	RP	RP	spray mix	See product page	Atomization technology (RP/HVLP)
--	--	--	--	■	■	■	Internal control
■	■	■	■	--	■	■	External control
22 - 27	22 - 26	16 - 27	24 - 27	Depending on material nozzle	Depending on nozzle set		* Spray fan width in cm
100 - 160	60 - 200	60 - 170	170 - 760				* Material flow in g/min
150	220	200	200				** Air consumption in l/min at 2.5 bar
■	■	■	■	■	--	--	Material circulation
--	--	--	■	--	--	--	Optional: Extensions
■	■	--	--	--	--	■	Externally controlled robotic systems
--	--	■	--	■	■	■	Robotic painting systems with adjustment of the spray parameters on the spray gun
--	--	--	■	--	--	--	Marking applications, component marking
Standard: -- Stainless steel: 620		Standard: 520 Stainless steel: --		Standard: 525 Stainless steel: --	Standard: 625 Stainless steel: 835	Depending on the model execution	Spray gun weight in g
125		125		127	145		Spray gun length in mm
45 x 45		35 x 35		35 x 35	45 x 45	45 x 45	Width x height in mm
--		--		--	--	45°	Air cap fixation
HVLP: 0.3; 0.5; 0.8; 1.0; 1.2				RP Round/flat fan: 0.5; 0.8; 1.3; 2.0	Depending on the model version (see pages with details)	Depending on the model version (see pages with details)	Available nozzle sizes
RP: 0.3; 0.5; 0.8; 1.0; 1.2				RP round fan: 0.5; 0.8			
--		■		■	■	--	Standard version Anodized aluminium
■		--		--	■	■	Stainless steel version
G 1/4 Female thread		G 1/4 Female thread		G 1/4 Female thread	G 1/4 Female thread	G 1/4 Female thread	Connection thread Material inlet/-outlet, control air, atomization air
ROB		--		--	--	--	Optional: Quick change adapter
Finest atomisation for small surfaces				Defined edge marking, high frequency	Atomisation air supported air mix/spray mix technology	Colour tone and paint batch control in laboratories	Coating requirements
Optionally available as stainless steel version		--		--	Airless technology/max. material pressure range up to 250 bar	Scalable and reproducible adjustment parameters	For the use with waterborne paint systems and materials
External adjustment of round and flat fan as well as material flow		Manual adjustment of round and flat fan as well as material flow		High surface efficiency with low overspray	Gravity flow cup version with suction nozzle technology		Control/Adjustment
Atomization air Continuous air flow		Atomization air continuous flow				Internally controlled Pre and Post air, i.e. no external control valve required	

* Material flow rate and fan size are approximate values and depend on the nozzle size being used. These values have been determined using paints with a viscosity between 17 and 24 sec. DIN 4, material pressure 0.6 - 0.9 bar and atomisation air pressure 3.5 - 4.5 bar (exact values have to be determined with the actual operating parameters and paint materials).

** Air consumption is only an approximate value and is depending on the nozzle size; pressure measured at spray gun inlet.

Technical modifications and printing errors reserved

SATAjet® 3000 ROB RP®/HVL P



SATAjet 3000 ROB RP							
Technical Data				Operating pressure: 51 - 58 psi			
				Air consumption: 15.5 cfm			
Nozzle	0.5	0.8	1.1	1.3	1.5	1.7	2.0
Standard version with Standard (STD) or Specially Treated (ST) Nozzle							
Order No. STD	163931	94516	94524	135467	220418	94559R	94570R
Order No. ST	-	94516ST	94524ST	137893	94550RST	94559RST	94570RST
Waterborne version with Standard (STD) or Specially Treated (ST) Nozzle							
Order No. STD	220434	94557	94565	130476	220442	94593R	94603R
Order No. ST	-	146928	220467	220475	94585RST	94593RST	94603RST
Stainless steel version with material flow control							
Order No. STD	*	204883	220491	220509	*	*	*
Stainless steel version with lifetime prolonging surface treatment of fluid tip and paint needle							
Order No. STD	*	146928	220467	220475	*	*	*
Stainless steel version with material circulation for the use on quick change adapter 188573							
Order No. STD	220483	182063	97857	182071	*	*	*
Stainless steel version with material circulation, with material flow control for the use on quick change adapter 188573							
Order No. STD	*	205401	220541	*	*	*	*
Nozzle	0.5	0.8	1.1	1.3	1.5	1.7	2.0
Nozzle Set							
Order No. STD	129932	94136	94144	128322	135459	94170R	144253
Order No. ST	220558	137992	140889	138008	94160RST	94170RST	128777ST



SATAjet 3000 ROB HVL P							
Technical Data				Operating pressure: 58 - 61 psi			
				Air consumption: 20 cfm			
Nozzle	0.5	0.8	1.0	1.2	1.6	2.0	
Standard version with Standard (STD) or Specially Treated (ST) Nozzle							
Order No. STD	220426	94532	94540	124651	180976	94568R	
Order No. ST	-	94532ST	94540ST	124651ST	94556RST	94568RST	
Waterborne version with Standard (STD) or Specially Treated (ST) Nozzle							
Order No. STD	220459	94573	94581	124644	129395	129403	
Order No. ST	-	94573ST	94581ST	124644ST	129395ST	129403ST	
Nozzle	0.5	0.8	1.0	1.2	1.6	2.0	
Nozzle Set							
Order No. STD	129940	94151	94169	126433	124206	124214	
Order No. ST	139659	139667	94169ST	138016	140814	140822	



Spare Parts SATAjet® 3000 ROB RP®/HVLP

Order No./Desc.	
10033	Air cap ring w/seal, 3000 RP
14183	Tool kit
38638	Air distribution ring
38638-3	Air dist. ring, pk of 3
38638-5	Air dist. ring, pk of 5
38638-20	Air dist. ring, pk of 20
41780	Gun body only (specify gun)
43091	Control piston
43109	Closing cap
64071	Seal retainer
64147	Washer
64709	Sleeve
64808	Spring, compression
68999	Repair kit
68999-S	Spring set
74179	Inner material seal
74690	Allen screw, M5x25
80598	Seal retainer Front mount
91728	Nozzle head, 3000 ROB HVLP & RP
92627	S/S nozzle head, 3000 ROB HVLP & RP
93732	Air cap ring w/seal, HVLP
94714	Pin only
97824	Air distribution ring, w/puller, pk of 3
170787	Seal retainer Rear mount

Rear mount seal #170787 (Late 2014 release)

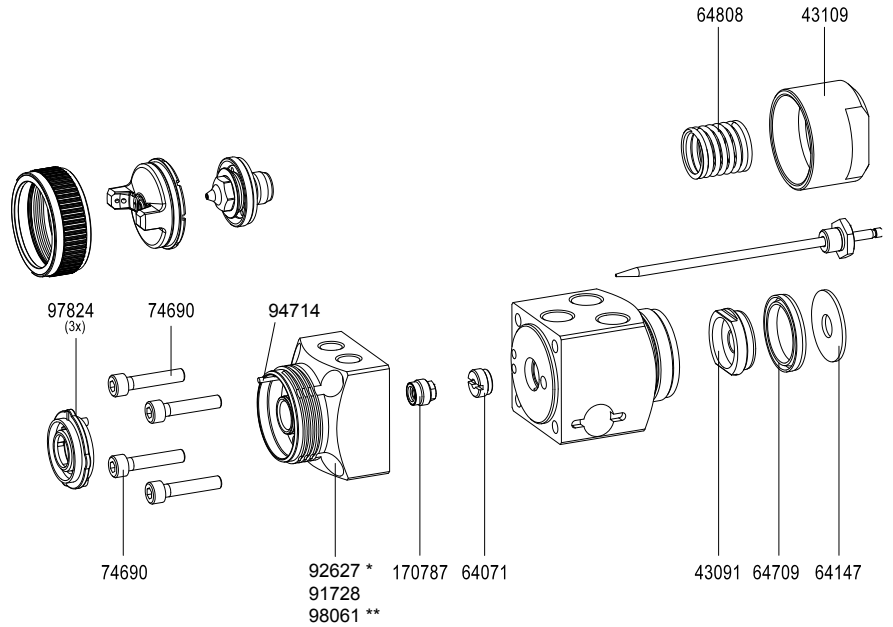

14183 Tool Kit (common)

901	Universal spanner wrench	
3509	Cleaning brush	
43638	Extraction tool	
71431	Allen wrench 4mm	
76307	Socket wrench	

Front mount seal #80598

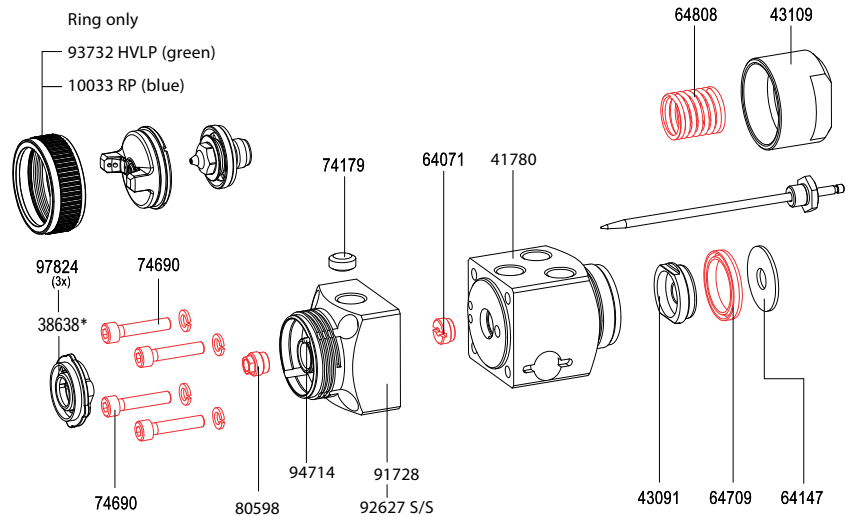



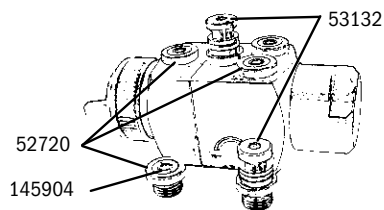



ROB Accessories and parts	
74773	Single Gun Adapter, LP ROB
56622	Dual Gun Adapter, LP ROB
53132	Connection Bolt G1/4, Adapter Plate
52720	Spacer Block, Pk of 3, Adapter Plate
145904	O Ring only, Pk of 10



Order No./Desc.

68999
Repair kit

Quick change adapter SATAjet A / ROB

Quick-change recording quick change holders		
145169	Quick-change adapter cpl. SATA automatic guns , with mounting screw, with spacers 52720	
208595	<p>FIRA quick-change adapter with integrated precision pressure regulator , incl. connecting elements for SATAjet A automatic guns</p> <p>FIRA (Fluid Integrated Regulator Adapter) quick change adapter with integrated material fine pressure regulator, includes connection elements for SATAjet ROB automatic guns.</p> <p>Innovative, compact adapter for automatic spray guns allowing the quick removal of the automatic gun for maintenance purposes. Furthermore, a pneumatically operated material fine pressure regulator is integrated in the adapter ensuring a pulsation free material supply. The controller can be either adjusted centrally via the pneumatic anchorage or externally via the control of the entire unit</p>	
217521	Quick-change recording cpl. including without material return . Connection elements for a material connection for SATAjet ROB standard spray gun	
188573	Quick-change recording cpl. included with material return . connection elements for SATAjet ROB guns	
208603	FIRA quick-change recording material with integrated precision pressure regulator , incl. Connecting elements for SATAjet ROB automatic guns	
74773	Quick change adapter with fixing screw without spacers 52720 and 53132 for fitting a SATAjet ROB - gun	

Drilling patterns for quick change holders on request.

Technical modifications and printing errors reserved

FIRA quick change adapter SATAjet A / ROB

Only for the series ▶

- SATAjet 3000 A RP/HVLP
- SATAjet 1000 A RP/HVLP
- SATAminijet 1000 A RP/HVLP

Art. No./Descr.
52720 Distance piece 1/4" (male thread) (packing unit 3 pieces)
145169 Quick change adapter cpl. with fixing screw, with distance pieces 52720
188649 Sealing kit (packing unit 10 pieces)

Drilling template for adapter plate connection upon application.

* included in the scope of delivery of 145169.

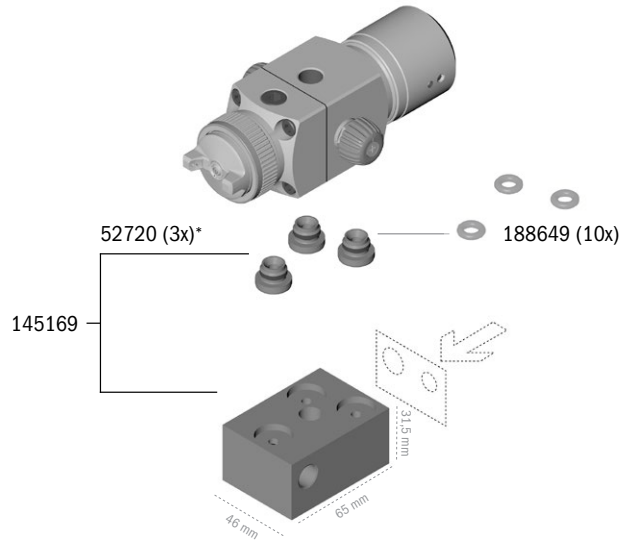
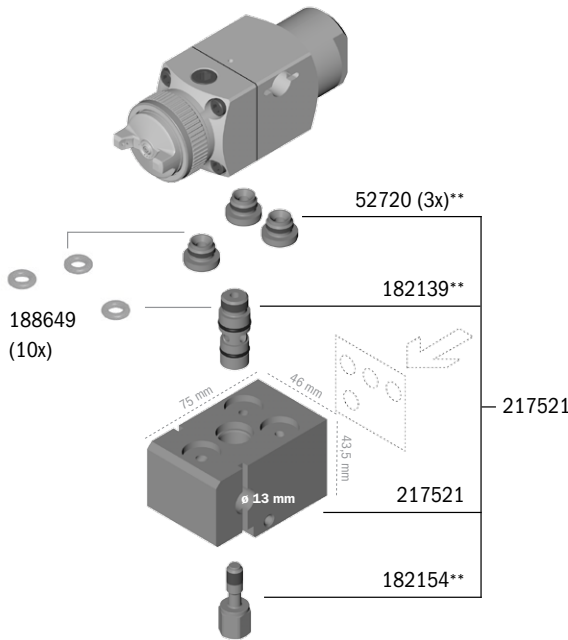

Quick change adapter without material circulation

◀ Only for the series

- SATAjet 3000 ROB RP/HVLP
- SATAminijet 1000 ROB RP/HVLP

Art. No./Descr.
52720 Distance piece 1/4" (male thread) (packing unit 3 pieces)
182139 Connection piece control air 1/4" (male thread)
217521 Quick change adapter cpl. without material recirculation incl. connection elements for one material connection
182154 Screw for SATAjet 3000 ROB special version
188649 Sealing kit (packing unit 10 pieces)

Drilling template for adapter plate connection upon application.

** included in the scope of delivery of 217521.

Quick change adapter with material circulation

Only for the model ranges ▶

- SATAjet 3000 ROB RP/HVLP
- SATAminijet 1000 ROB RP/HVLP (upon application)

Art. No./Descr.
52720 Distance piece 1/4" (male thread) (packing unit 3 pieces)
188631 Distance piece 1/8" (male thread) (packing unit 2 pieces)
182139 Connection piece control air 1/4" (male thread)
188573 Adapter, cpl. with material recirculation
182154 Screw for SATAjet 3000 ROB special version
145904 O-ring (packing unit 10 pieces)
188649 Sealing kit (packing unit 10 pieces)

Drilling template for adapter plate connection upon application.

*** included in the scope of delivery of 188573.

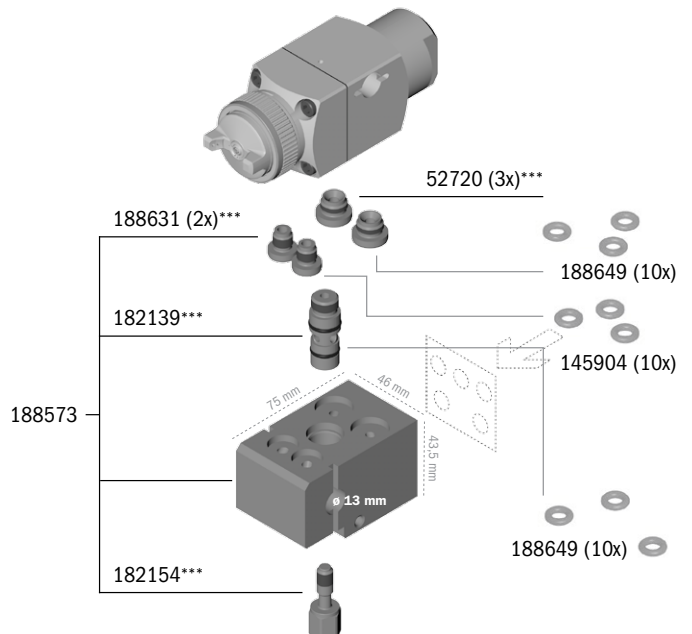

FIRA Quick Change Adapter SATAjet A / ROB

With integrated, pneumatically controllable material fine pressure regulator

Product advantages / Function

- Combination of external, pneumatically controlled material fine pressure regulator and
- automatic spray gun quick change adapter in compact design
- Replaces a separate material fine pressure regulator on the spray gun
- Control of the material volume flow by the external control directly in the quick change adapter
- High control accuracy due to known control mechanism
- High quality, wear-and-tear resistant PTFE diaphragm
- Allows quick spray gun change
- Suitable for all standard SATAjet A and SATAjet ROB automatic spray guns



Art. No./Descr.

208595

FIRA quick change adapter with integrated material fine pressure regulator, incl. connection elements for SATAjet A automatic spray guns

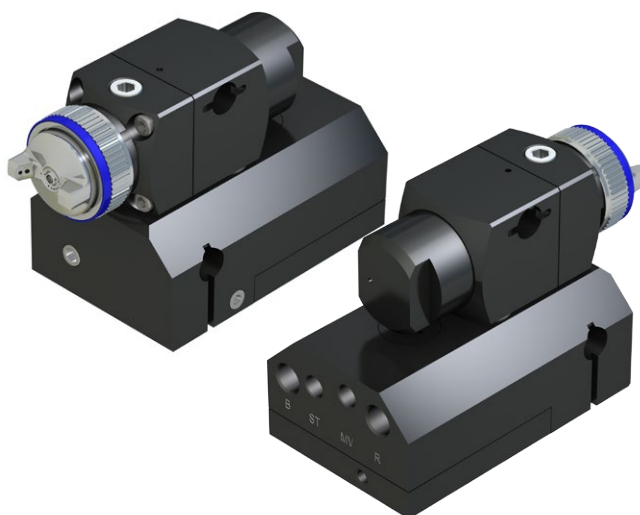

Art. No./Descr.

208603

FIRA quick change adapter with integrated material fine pressure regulator, incl. connection elements for SATAjet ROB automatic spray guns

Notes



Technical modifications and printing errors reserved

SATAjet® 3000 A RP®/HVLP



SATAjet 3000 A RP							
Technical Data				Operating pressure: 51 - 58 psi			
				Air consumption: 15.5 cfm			
Nozzle	0.5	0.8	1.1	1.3	1.5	1.7	2.0
Standard version with Standard (STD) or Specially Treated (ST) Nozzle							
Order No. STD	220376	94417	94425	94433	220384	94453A	220392
Order No. ST	168559	174060	94425ST	196378	94445AST	94453AST	182378
Waterborne version with Standard (STD) or Specially Treated (ST) Nozzle							
Order No. STD	165274	94466	94474	94482	143289	94503A	220400
Order No. ST	-	181008	169011	94482ST	94494AST	94503AST	94520AST
Nozzle	0.5	0.8	1.1	1.3	1.5	1.7	2.0
Nozzle Set with Standard (STD) or Specially Treated (ST) Nozzle							
Order No. STD	129924	94326	94334	94324	94359	94369A	131052
Order No. ST	168583	216887	171710	94342ST	94359ST	94369AST	94377AST
Test Air Cap	135517	135517	135517	135517	135517	-	-



SATAjet 3000 A HVLP									
Technical Data				Operating pressure: 58 - 61 psi					
				Air consumption: 20 cfm					
Nozzle	0.5	0.8	1.0	1.2	1.6	2.0			
Standard version with Standard (STD) or Specially Treated (ST) Nozzle or Carbide (CB) Nozzle									
Order No. STD	-	94441	94458	124602	124594	124545			
Order No. ST	-	94441ST	94458ST	124602ST	124594ST	125545ST			
Order No. CB	-	94490AC	94508AC	94526AC	94544AC	188276			
Waterborne version with Standard (STD) or Specially Treated (ST) Nozzle									
Order No. STD	156604	180992	94508	124610	124552	124560			
Order No. ST	-	94490ST	94508ST	124610ST	124552ST	124560ST			
Nozzle	0.5	0.8	1.0	1.2	1.6	2.0	1.2HM	1.6HM	2.0HM
Nozzle Set									
Order No. STD	129916	94367	94375	129577	129700	129718			
Order No. ST	129916ST	94367ST	94375ST	129577ST	129700ST	129718ST			
Order No. CB		96760A	96768A	96776	96784	96792	96776	96784	96792
Test Air Cap	-	95059	95059	95067	95067	95067			



Connection options			
144618	Fixing bolt, D 15 G 1/4"		
64212A	Collar mount for 1/2" shaft, G 1/4" connection		
801102	Quick change mount w/indexing angle bracket, complete with hardware Individual parts sold separately, call for part numbers.		
208595	FIRA (Fluid Integrated Regulator Adapter) quick change adapter with integrated material fine pressure regulator. Includes connection elements for SATAjet A automatic spray guns. SEE PAGE 76		

Technical modifications and printing errors reserved

Spare Parts SATAjet® 3000 A RP®/HVLP

Order No./Desc.	
1503	Countersunk screw M4 x 8
1594	Teflon seal
3418	Washer, 3.7
3574	Spring, needle packing
10033	Air cap ring w/seal, RP
11403	S/S nipple, 1/4 x 3/8
11544	Spring, needle
14183	Tool kit
29827	Spring, pk of 12
38638	Air distribution ring
38638-3	Air dist. ring, pk of 3
38638-5	Air dist. ring, pk of 5
38638-20	Air dist. ring, pk of 20
54221	Control spin
64071	Seal retainer
64089	Gun body only (specify gun)
64105	Control piston
64147	Washer
64154	Hollow screw
64709	Sleeve
64766	Spacer
64808	Spring, compression
64857	Seal retainer, complete
64865	Control piston, complete
64873	End cap, complete
64881	Control cap
67082	Repair kit
67082-P	Packing set
67082-S	Spring set
69872	O ring, 11x1
70789	O ring, 5x2
73783	Hex socket screw
74179	Inner material seal
74690	Allen screw, M5x25
80598	Seal retainer
91728	Nozzle head, 3000 ROB HVLP & RP
92627	S/S nozzle head, 3000 ROB HVLP & RP
93732	Air cap ring w/seal, HVLP
93765	Nozzle head, K3 Auto HVLP & RP
93773	S/S nozzle head, wo/pin K3 Auto HVLP & RP
94714	Pin
97824	Air distribution ring, w/puller, pk of 3
133934	O ring, 11x1, pk of 3
140574	Control knob w/screw
144618	Mounting post 15mm, G 1/4"
170787	Seal retainer

Rear mount seal #170787 (Late 2014 release)

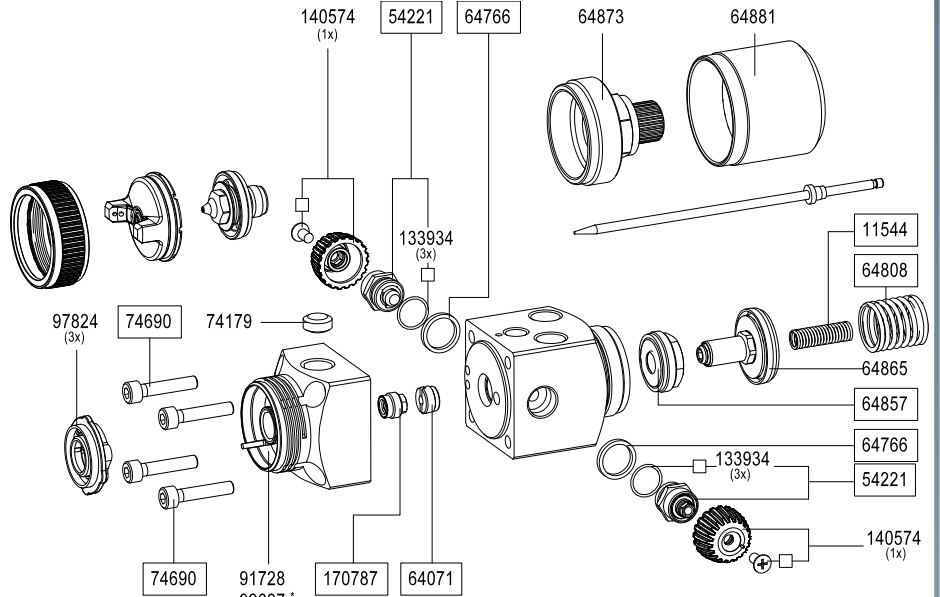

14183 Tool Kit (common)	
901	Universal spanner wrench
3509	Cleaning brush
43638	Extraction tool
71431	Allen wrench 4mm
76307	Socket wrench

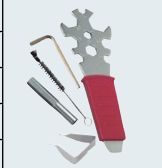

Order No./Desc.
217505
Repair kit

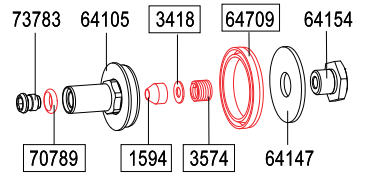

Front mount seal #80598

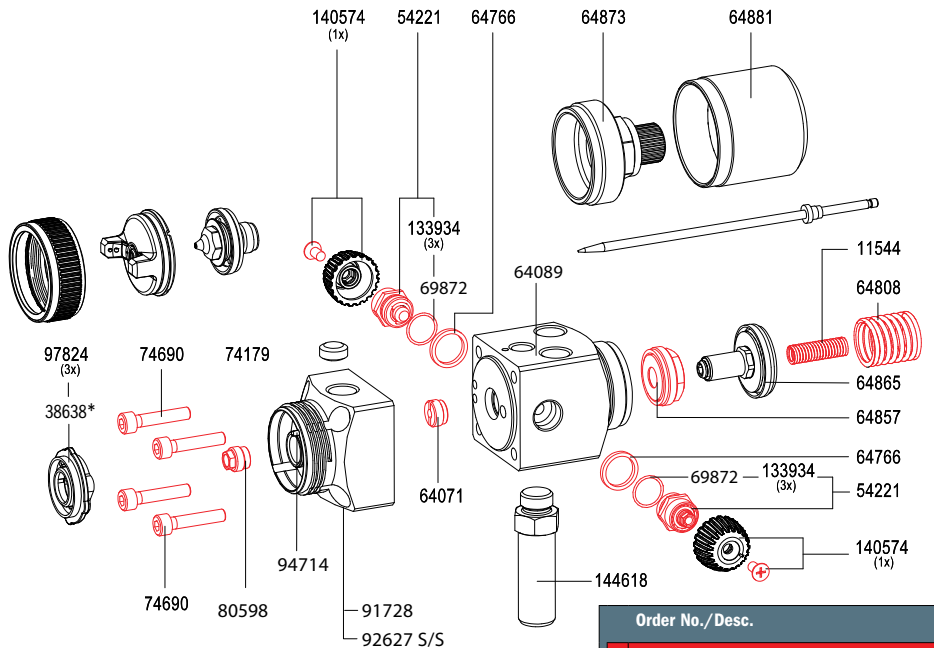

Order No./Desc.
67082
Repair kit

Technical modifications and printing errors reserved

SATAjet® 1000 A RP



SATAjet 1000 A RP							
Technical Data		Air consumption 15 cfm at 50 psi					
		Operating pressure: 50 - 60 psi					
		Required min. control air pressure: 45 psi					
		Maximum permissible operating air pressure: 150 psi					
		Maximum permissible operating material pressure: 75 psi					
Nozzle	0.5	0.8	1.1	1.3	1.5	2.0	3.0
Standard version							
Art. No.	195198	164129	164137	164145	164152	164160	
Stainless steel version							
Art. No.		164178	164186	164194	164202	164210	185074
Nozzle set							
Art. No.		164228	164236	164244	164251	164269	185082

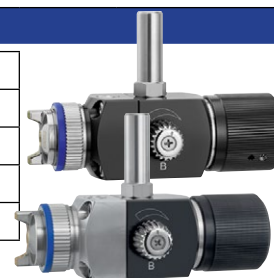

Test air cap for the setting the required spray parameters (reproducibility).		
184747	Test air cap 0.5 - 1.7 cpl. with 2 pressure gauges, cpl. for SATAjet 1000 K/A/ROB RP	

SATAjet 1000 A RP without nozzle set for extensions	
169870	SATAjet 1000 A RP without nozzle set
169888	SATAjet 1000 A RP WA without nozzle set, version for waterborne paints

Plate-shaped internal mixing extension	
164277	SATA plate-shaped internal mixing extension for SATAjet 1000 A RP, length 20 cm, nozzle 1.6, 360°
164285	SATA plate-shaped internal mixing extension for SATAjet 1000 A RP, length 30 cm, nozzle 1.6, 360°



Nozzle sizes between 0.8 and 2.0 and lengths between 100 and 1,000 mm are available upon request.

Diagonal spray extension	
164293	SATA diagonal spray extension only for SATAjet 1000 A RP, length 20 cm, nozzle 1.6
164301	SATA diagonal spray extension only for SATAjet 1000 A RP, length 30 cm, nozzle 1.6



Nozzle sizes between 0.8 and 2.0 and lengths between 100 and 1,000 mm are available upon request.

Spare Parts SATAjet® 1000 A RP

Art. No./Descr.
1594
Teflon seal for paint needle
3418
Washer 3,7 DIN 125, brass
3574
Compression spring
11544
Compression spring for paint needle
54221
Spindle complete
64071
Seal retainer, cpl. w. needle packing (air side)
64105
Control piston for SATA LP, ready for assembly
64147
Washer for SATA LP90, ready for assembly
64154
Hollow screw for SATA LP90, ready for assembly
64709
Sleeve for SATA LP90
64766
Spacer
64808
Compression spring for SATA LP90
64857
Seal retainer LP90, big, complete, with piston packing
64865
Control piston for SATA LP90, cpl.
64873
End cap for LP90, complete
64881
Control cap for LP90, complete
70789
O-ring 5 x 2 mm, ethylene-propylene
73783
Hexagonal socket-head screw for LP90
74179
Intermediate piece for LP90
74690
Cylindrical screw M5x25, A2 stainless steel, DIN 912, for LP90 guns (version for water borne paints)
80598
Seal retainer, cpl. w. 2 packings and metal ring, for paint needle 3.5 mm - material side
133934
Pack of 3 packings
140574
Control knob and screw (each 1)
140582
Pack of 5 sealing elements
143230
Pack of 3 air distribution rings
144618
Fixing bolt D 15 - G 1/4
164095
Nozzle head, cpl., jet 1000 A and ROB
164111
Nozzle head, cpl., version waterborne paint jet 1000 A and ROB

Rear mount seal #170787 (Late 2014 release)

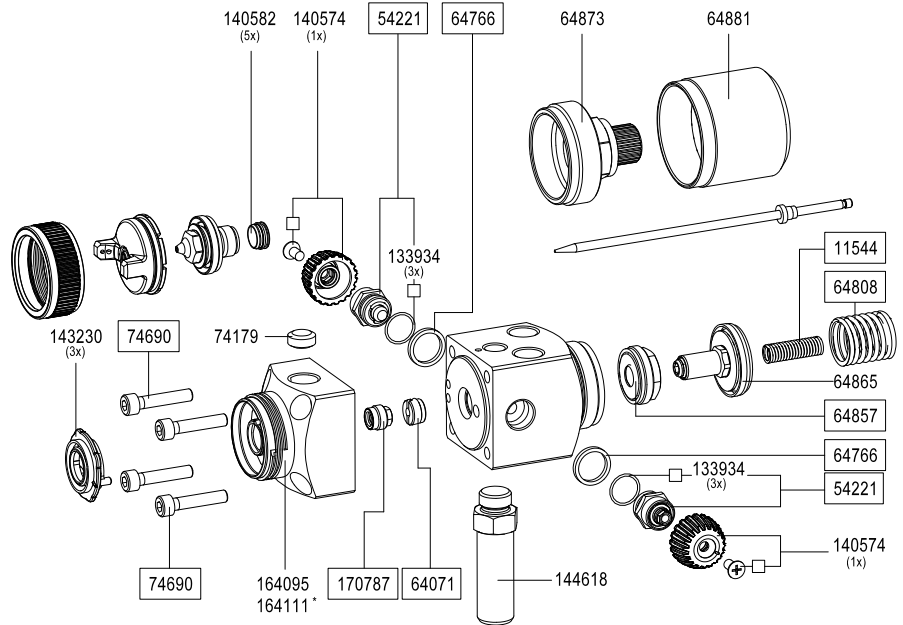

Order No./Descr.
<input type="checkbox"/> 217505
Repair kit

14183 Tool Kit	
901	Universal spanner wrench
3509	Cleaning brush
43638	Extraction tool
71431	Allen wrench 4mm
76307	Socket wrench

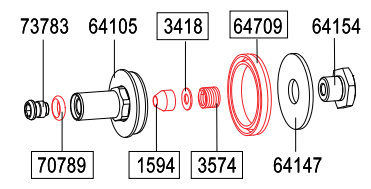

Front mount seal #80598

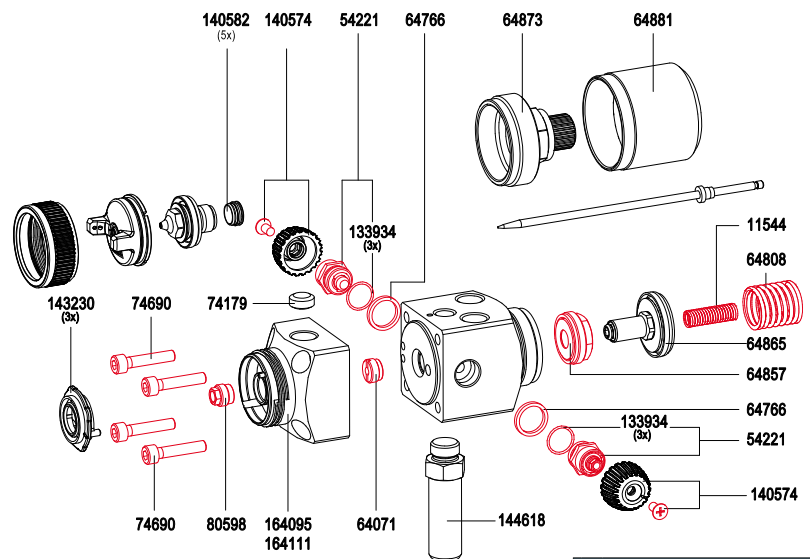

Order No./Descr.
<input type="checkbox"/> 67082
Repair kit

Technical modifications and printing errors reserved

SATaminijet® 1000 A RP/HVLP

SATaminijet 1000 A RP

Technical Data	Air consumption at 36 psi: 7 cfm		
Internally controlled automatic spray gun for finest atomization on small surfaces	Atomization air pressure on the spray gun: 36 - 45 psi		
	Required min. control air pressure: 45 psi		
	Max. permissible material operating pressure: 72 psi		
	Maximum permissible operating temperature of the coating material: 80 °C		
	Weight cpl. without connections:	Stainless steel:	915 g



Nozzle	0.3	0.5	0.8	1.0	1.2
---------------	-----	-----	-----	-----	-----

Stainless steel version

Art. No.	220517	203596	203604	220525	220533		
-----------------	--------	--------	--------	--------	--------	--	--

Nozzle set

Art. No.	203661	203679	203687	203695	203703		
-----------------	--------	--------	--------	--------	--------	--	--

* available upon application

Test air caps for setting the required spray parameters (reproducibility).

204867	Test air cap 0.3 - 1.2 with 2 pressure gauges, cpl. for SATaminijet 1000 K/A/ROB RP		
--------	---	--	---

SATaminijet 1000 A HVLP

Technical Data	Air consumption at 36 psi: 6 cfm		
Internally controlled automatic spray gun for the finest atomization on small surfaces	Atomization air pressure on the spray gun: 36 - 45 psi		
	Required min. control air pressure: 45 psi		
	Maximum permissible material operating pressure: 145 psi		
	Maximum permissible operation temperature of the coating material: 80° C		
	Weight cpl. without connections:	Stainless steel:	915 g



Nozzle	0,3	0,5	0,8	1,0	1,2	1,4
---------------	-----	-----	-----	-----	-----	-----

Stainless steel version

Order No.	170746	170753	170761	170779	194902	*	
------------------	--------	--------	--------	--------	--------	---	--

Nozzle set

Order No.	171009	171017	171025	171033	203711	*	
------------------	--------	--------	--------	--------	--------	---	--

* available upon request

Test air caps for setting the required spray parameters (reproducibility)

204875	Test air cap 0.3 - 1.2, with 2 pressure gauges, cpl. for SATaminijet 1000 K/A/ROB HVLP		
--------	--	--	---

Connection kits page 76-78

Spare Parts SATAmijnjet® 1000 A RP/HVLP

Art. No./Descr.
1594
Teflon seal for paint needle
3418
Washer 3,7 DIN 125, brass
3574
Compression spring
11544
Compression spring for paint needle
54221
Spindle complete
64071
Seal retainer, cpl. w. needle packing (air side)
64105
Control piston for SATA LP, ready for assembly
64147
Washer for SATA LP90, ready for assembly
64154
Hollow screw for SATA LP90, ready for assembly
64709
Sleeve for SATA LP90
64766
Spacer
64808
Compression spring for SATA LP90
64857
Seal retainer LP90, big, complete, with piston packing
64865
Control piston for SATA LP90, cpl.
64873
End cap for LP90, complete
64881
Control cap for LP90, complete
70789
O-ring 5 x 2 mm, ethylene-propylene
73783
Hexagonal socket-head screw for LP90
74179
Intermediate piece for LP90
74690
Cylindrical screw M5x25, A2 stainless steel, DIN 912, for LP90 guns (version for water borne paints)
127399
Pack of 3 air distribution rings
133934
Pack of 3 packings
140574
Control knob and screw (each 1)
144618
Fixing bolt D 15 - G 1/4
170787
Seal retainer, cpl. material side SATAmijnjet 3000 A and ROB
170803
Nozzle head, cpl., version waterborne paint SATAmijnjet 1000 A and ROB WA, HVLP
203588
Nozzle head, cpl. version waterborne paint SATAmijnjet 1000 A and ROB RP

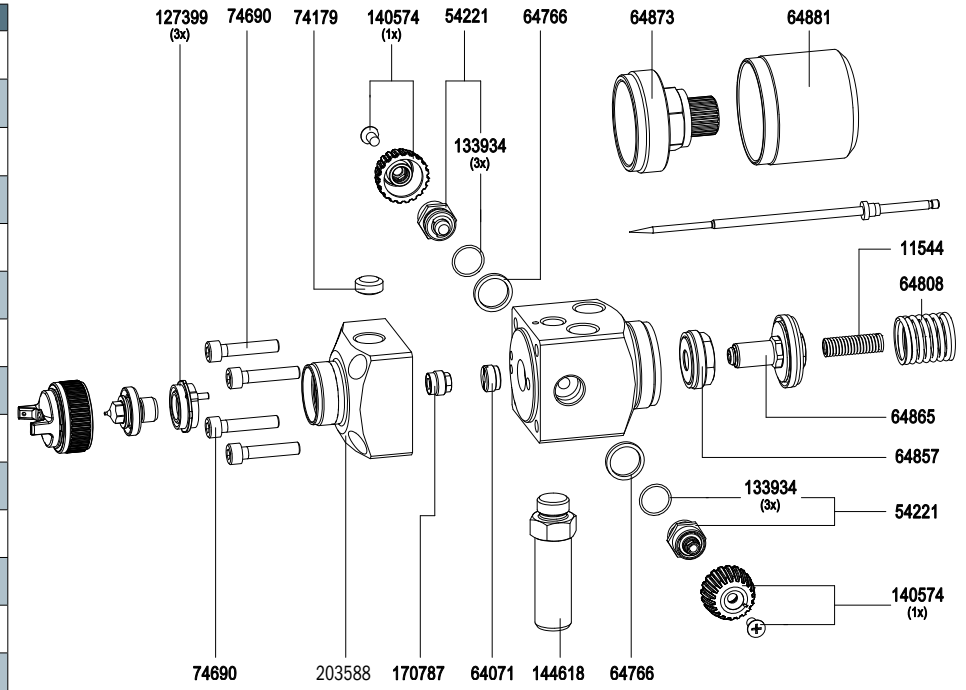

14183 Tool Kit	
901	Universal spanner wrench
3509	Cleaning brush
43638	Extraction tool
71431	Allen wrench 4mm
76307	Socket wrench

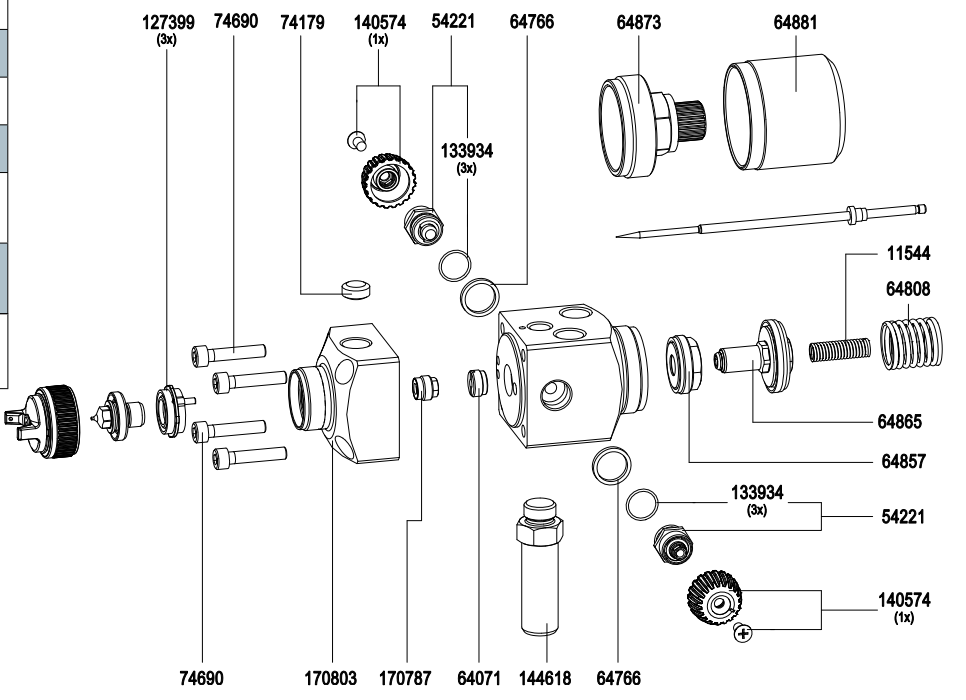
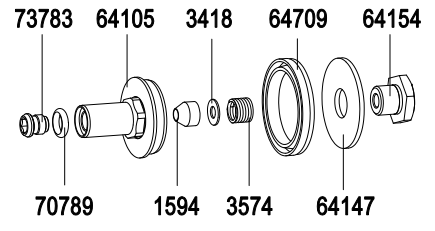

Technical modifications and printing errors reserved

SATaminijet® 1000 ROB RP/HVLP (previously SATaminijet 3000)



SATaminijet 1000 ROB RP

Technical Data	Air consumption: 7 cfm at 36 psi	
Externally controlled, fully-automatic spray gun for finest atomisation for small surfaces and components	Atomisation air pressure on the spray gun: 36 - 43 psi	
	Required min. control air pressure: 43 psi	
	Max. permissible material operating pressure: 145 psi	
	Maximum permissible operating temperature of the coating material: 176 °F	
	Weight cpl. without connections:	Stainless steel: 620 g



Nozzle	0,3	0,5	0,8	1,0	1,2
---------------	-----	-----	-----	-----	-----

Stainless steel version

Art. No.	220624	203612	203620	220632	220640	
-----------------	--------	--------	--------	--------	--------	--

Stainless steel version without material circulation for the use on quick change adapter 188557

Art. No.	*	195198	199182	*	*	
-----------------	---	--------	--------	---	---	--

Nozzle set

Art. No.	203729	195206	203737	203745	203752	
-----------------	--------	--------	--------	--------	--------	--

* available upon application

Test air caps for setting the required spray parameters (reproducibility).

204867	Test air cap 0.3 - 1.2 with 2 pressure gauges, cpl. for SATaminijet 1000 K/A/ROB RP	
--------	---	--

SATaminijet 1000 ROB HVLP

Technical Data	Air consumption: 5 cfm at 36 psi	
Externally controlled fully automatic spray gun for the finest atomization on small surfaces and components	Atomization air pressure on the spray gun: 36 - 43 psi	
	Required min. control air pressure: 43 psi	
	Maximum permissible material operating pressure: 145 psi	
	Maximum permissible operation temperature o the coating material: 176°F	
	Weight cpl without connections:	Stainless steel: 620 g



Nozzle	0,3	0,5	0,8	1,0	1,2	1,4
---------------	-----	-----	-----	-----	-----	-----

Stainless steel version

Order No.	220590	203638	203646	203653	220608	*
------------------	--------	--------	--------	--------	--------	---

Nozzle set

Order No.	203760	203778	203786	185678	185686	185694
------------------	--------	--------	--------	--------	--------	--------

* available upon request

Test air caps for setting the required spray parameters (reproducibility)

204875	Test air cap 0.3 - 1.2 , with 2 pressure gauges, cpl. for SATaminijet 1000 K/A/ROB HVLP	
--------	--	---

Technical modifications and printing errors reserved

Spare Parts SATAminijet® 1000 ROB RP/HVLP (previously SATAminijet 3000)

Art. Nr./Bez.
14183
Tool kit
64071
Seal retainer
64147
Washer
64709
Sleeve
64808
Compression spring
43091
Control piston
43109
Closing cap
74179
Zwischenstück, Kunststoff
74690
Allen screw, M5x25
170787
Seal retainer, cpl. material side, ROB and Auto
127399
Air distribution ring, (3x)
203588
Nozzle head , cpl. SATAminijet 1000 A and 1000 minijet ROB, RP, stainless steel
170803
Nozzle head, cpl. SATAminijet 1000 A and 1000 minijet , HVLP, stainless steel

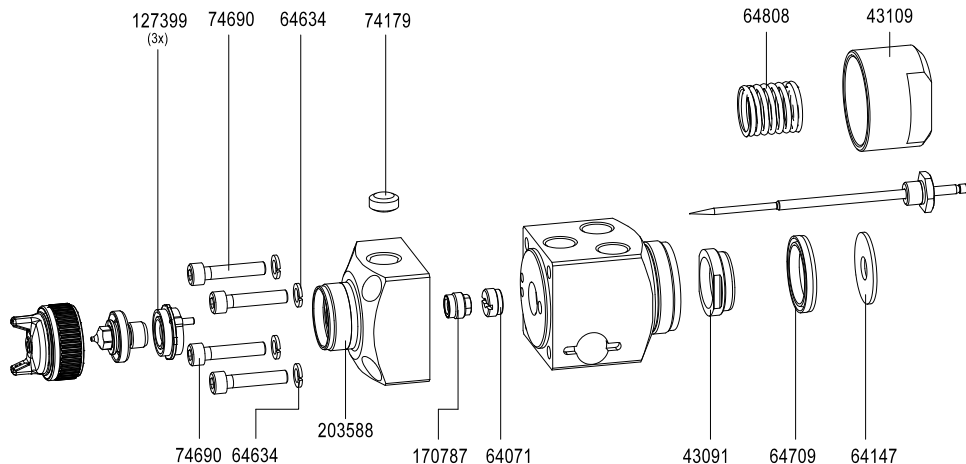

14183 Tool Kit	
901	Universal spanner wrench
3509	Cleaning brush
43638	Extraction tool
71431	Allen wrench 4mm
76307	Socket wrench

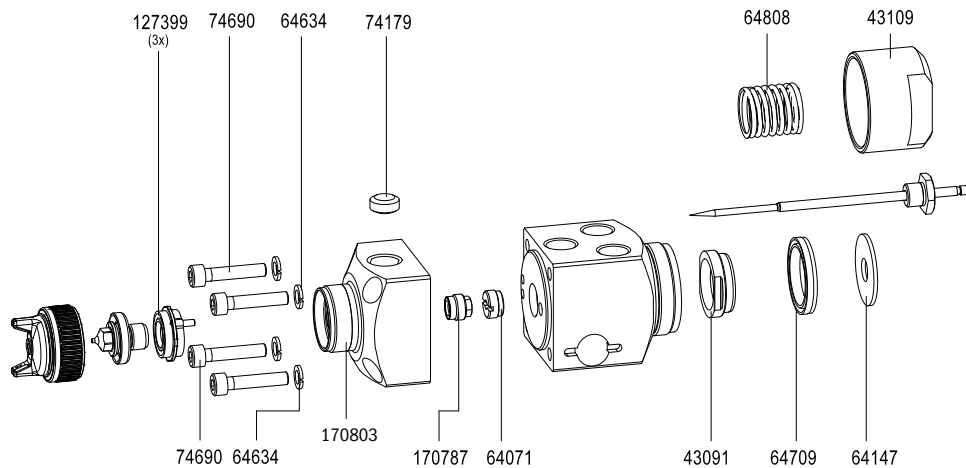

Technical modifications and printing errors reserved

SATAmijet® 1000 A S HVLP



SATAmijet 1000 A S HVLP

Technical Data	Air consumption: 7 cfm at 43 psi
Externally controlled automatic spray gun with high frequency for small components	Atomization air (72 - 80 psi): min. \varnothing 8 mm
	Required min. control air pressure: 43 psi
	Maximum permissible operating air pressure: 150 psi
	Maximum permissible operating material pressure: 75 psi
	Maximum permissible operating temperature of the coating material: 175° F



Nozzle	0,3	0,5	0,8	1,0
---------------	-----	-----	-----	-----

Standard version

Art. No.	149021	149039	149047	149054
-----------------	--------	--------	--------	--------

Nozzle set

Art. No.	149476	149484	149492	149500
-----------------	--------	--------	--------	--------

Spray guns and nozzle sets with life time prolonging surface treatment of fluid tip and paint needle available upon request.

Test air caps for setting the required spray parameters (reproducibility)

204875	Test air cap 0.3 - 1.2 , with 2 pressure gauges, cpl. for SATAmijet 1000 K/A/ROB HVLP
--------	--



Connection diagram | Material and air connections G 1/4 female thread

L x B x D= 125 x 35 x 35 mm

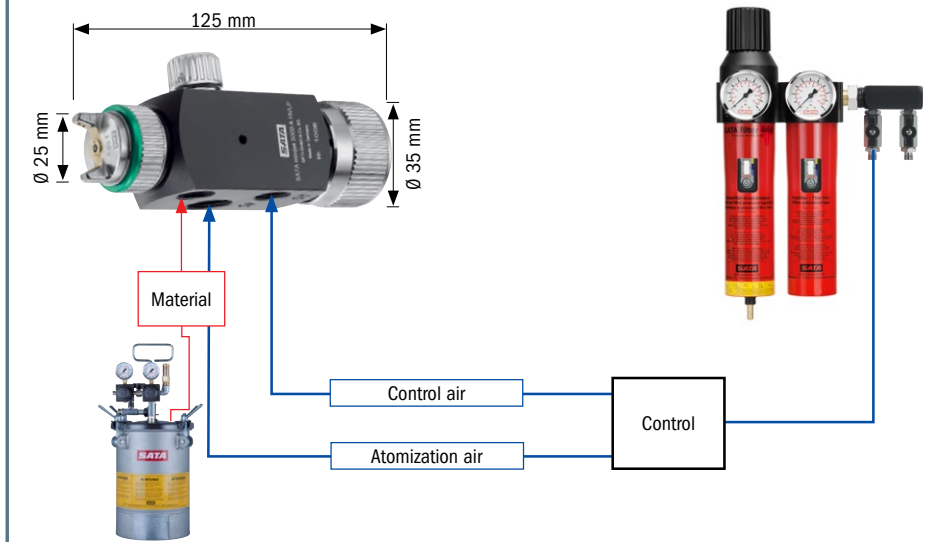

Spare Parts SATAminijet® 1000 A S HVLP

Art. No./Descr.
1503 Countersunk screw M4 x 8 DIN 965, stainless steel, for micrometer und round/flat spray control
1933 Teflon sealing for paint needle, packing unit: 5
2188 Spindle, complete, for regulation valve
3418 Washer 3,7 DIN 125, brass
3574 Compression spring
3582 Packing screw for SATAjet paint needle
20297 Compression spring for LP-S
22418 Teflon sleeve for LP-S
24349 Backing plate for LP
40253 Regulation cap LP-S, complete
45385 Hexagon nut M9X1 for taking sleeve (LP-S)
57976 Distance sleeve for SATA LP/S marking gun, ready for assembly
65557 Regulating knob and regulating valve
67116 Locking screw Ms R1/4 inch for LP90 and breathing set NIOSH
127399 Pack of 3 air distribution rings
144618 Fixing bolt D 15 - G 1/4

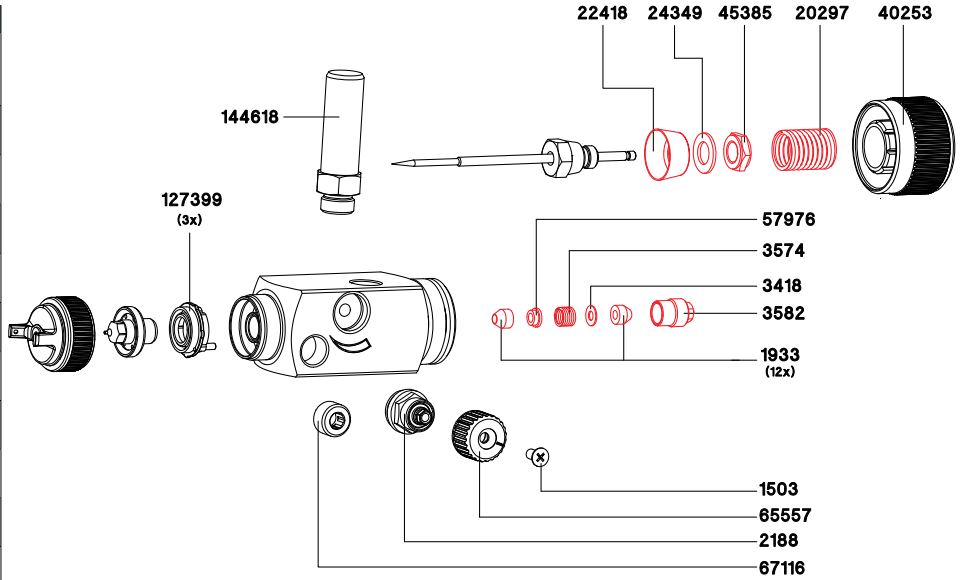

14183 Tool Kit

901	Universal spanner wrench
3509	Cleaning brush
43638	Extraction tool
71431	Allen wrench 4mm
76307	Socket wrench



Art. No./Descr.
40832 Repair kit for SATA LP-S

SATAjet® LPS 2000 RP®



SATA LPS RB 2000 RP, SATA LPS R 2000

Technical Data	Air consumption SATA LPS RB 2000 RP: 7 - 9 cfm at 45 psi
	Air consumption SATA LPS R 2000: 4 - 5 cfm at 29 psi
	Required min. control air pressure: 45 psi
	Maximum permissible operating air pressure: 150 psi
	Maximum permissible operating material pressure: 75 psi
	Permanent atomization air for high operating frequencies



Nozzle	0.5	0.8	1.3	2.0
---------------	-----	-----	-----	-----

SATA LPS RB 2000 RP marking gun with round and flat fan

Art. No.	92908	92916	129726	177444
-----------------	-------	-------	--------	--------

Nozzle set

Art. No.	93013	93021	93039	-
-----------------	-------	-------	-------	---

Nozzle sets with life time prolonging surface treatment of fluid tip and paint needle upon request.

Nozzle	0.5	0.8
---------------	-----	-----

SATA LPS R 2000 marking gun with round fan

Art. No.	92940	*
-----------------	-------	---

Nozzle set

Art. No.	93047	93054
-----------------	-------	-------

Nozzle set with life time prolonging surface treatment of fluid tip and paint needle

Art. No.	-	149286
-----------------	---	--------

* available upon application

Connection diagram | Material and air connections G 1/4 female thread

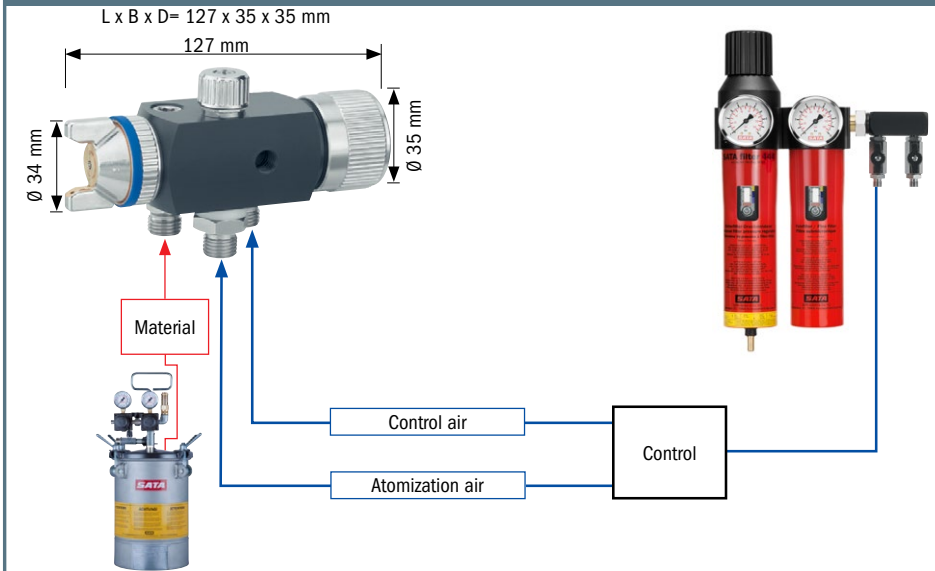



Parts SATAjet® LPS 2000 RP®

Order No./Descr.	
1503	Countersunk screw M4 x 8 DIN 965, stainless steel, for micrometer und round/flat spray control
1933	Teflon sealing for paint needle, packing unit: 5
3418	Washer 3,7 DIN 125, brass
3574	Compression spring
3582	Packing screw for SATAjet paint needle
3657	Control knob and regulation valve
3939	Spindle cpl. for LP90 lab test gun
20297	Compression spring for LP-S
22418	Teflon sleeve for LP-S
24349	Backing plate for LP
40253	Regulation cap LP-S, complete
40832	Repair kit
45385	Hexagon nut M9X1 for taking sleeve (LP-S)
57976	Distance sleeve for SATA LP/S marking gun, ready for assembly
62513	Air distribution ring, sn. below 30,000
64212	14mm, M10 x 1.5
64766	Spacer
67116	Locking screw Ms R1/4 inch for LP90 and breathing set NIOSH
69724	Closing screw LP-90-spray mix
133934	Pack of 3 packings
134593	Pack of 3 air distribution rings for SATA LM 2000
144618	Fixing bolt D 15 - G 1/4

SATA LPS RB 2000 RP

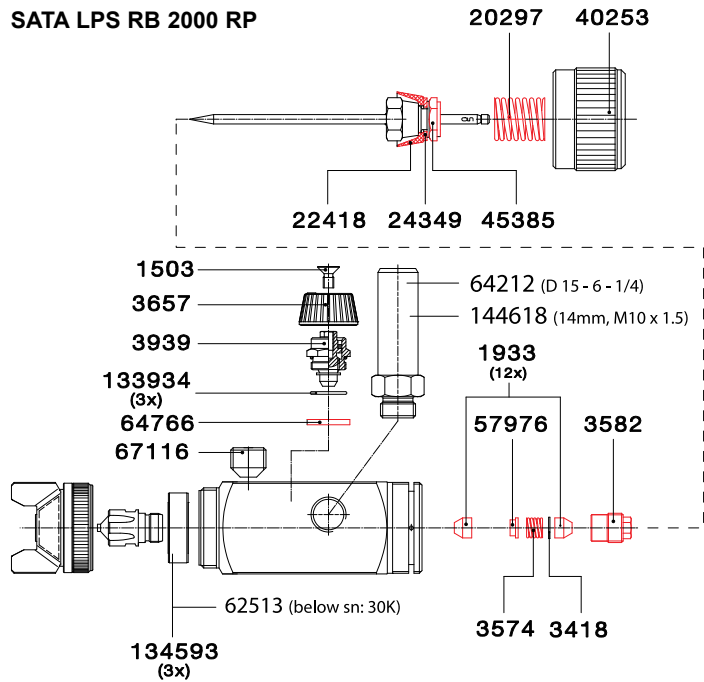

SATA LPS R 2000

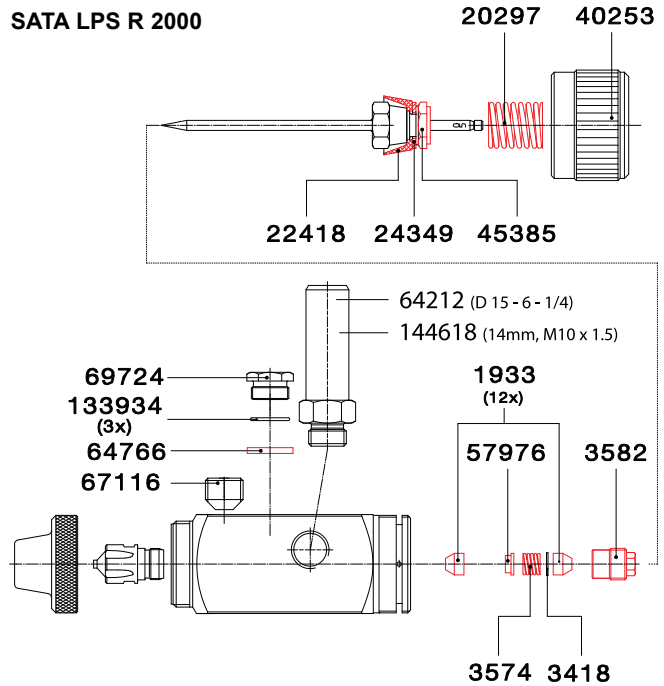

Technical modifications and printing errors reserved

14183 Tool Kit	
901	Universal spanner wrench
3509	Cleaning brush
43638	Extraction tool
71431	Allen wrench 4mm
76307	Socket wrench

Art. No./Descr.
40832
Repair kit for SATA LP-S



SATAJet® 3000 A spray mix



SATAJet 3000 A spray mix

Technical Data	Air consumption at 45 psi	Flat fan: 3 cfm
		Round fan: 8 cfm
	Required min. control air pressure: 45 psi	
	Maximum permissible operating air pressure: 150 psi	
	Maximum permissible operating material pressure: 3626 psi	
Maximum permissible operating temperature of the coating material: 120° F		



Standard version

144519	SATAJet 3000 A spray mix with round / flat spray control, without material nozzle
--------	---

Stainless steel version

144527	SATAJet 3000 A spray mix for waterborne materials, with round / flat spray control, without material nozzle
--------	---

Strainer

70615	SATA material filter R 1/4" 100 MSH filter
-------	--

Nozzles SATAJet 3000 A spray mix (not contained in scope of supply of spray mix gun)

Fluid tip		Technical Data				
Nozzle No.	Art. No.	mm	inch	Angle	Width	16 l/min at 70 bar (1015 psi)
1840	23044*	0.18	0.007	40°	18	0.16
2325	7328	0.23	0.009	25°	14	0.23
2350	7435	0.23	0.009	50°	22	0.23
2360	74922	0.23	0.009	60°	24	0.23
		0.25	0.010	20°/50°	14/22	0.25
2825	16998	0.28	0.011	25°	14	0.30
2850	50906	0.28	0.011	50°	22	0.30
2865	13771	0.28	0.011	65°	26	0.30
		0.30	0.012	20°/50°	14/22	0.38
3325	20206	0.33	0.013	25°	14	0.45
3350	50898	0.33	0.013	50°	23	0.45
3365	13789	0.33	0.013	65°	28	0.45
3375	74930	0.33	0.013	75°	32	0.45
3390	73742	0.33	0.013	90°	40	0.45
		0.35	0.014	20°/50°	14/24	0.50
3825	13797	0.38	0.015	25°	15	0.61
3850	7344	0.38	0.015	50°	25	0.61
3882	74948	0.38	0.015	82°	34	0.61
		0.40	0.016	20°/50°	14/25	0.70
4650	19307	0.46	0.018	50°	25	0.95
4682	74955	0.46	0.018	82°	35	0.95
5370	150276	0.53	0.021	70°	33	1.28
6050	17004	0.60	0.024	50°	31	1.59

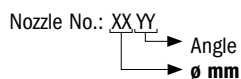

Connection kits page 76-78

Spare Parts SATAjet® 3000 A spray mix

Art. No./Descr.	
1594	Teflon seal for paint needle
3046	Seal retainer complete, for nozzle head LP90/spray mix
3418	Washer 3,7 DIN 125, brass
3574	Compression spring
18341	Compression spring
54221	Spindle complete
64105	Control piston for SATA LP, ready for assembly
64147	Washer for SATA LP90, ready for assembly
64154	Hollow screw for SATA LP90, ready for assembly
64709	Sleeve for SATA LP90
64766	Spacer
64808	Compression spring for SATA LP90
64857	Seal retainer LP90, big, complete, with piston packing
64865	Control piston for SATA LP90, cpl.
69708	Seal retainer for LP90/spray mix cpl. w. needle packing
70789	O-ring 5 x 2 mm, ethylene-propylene
73783	Hexagonal socket-head screw for LP90
74179	Intermediate piece for LP90
74690	Cylindrical screw M5x25, A2 stainless steel, DIN 912, for LP90 guns (version for water borne paints)
97824	Pack of 3 air distribution rings
98434	Pre-nozzle, cpl.
98459	Air cap, cpl. Round / flat fan
98541	Needle tip, cpl.
98665	Air cap ring, for 3000 A spray mix only
133934	Pack of 3 packings
140574	Control knob and screw (each 1)
144535	Nozzle head cpl. for SATA LP jet K3 spray mix, pre-assembled
144543	Nozzle head cpl. for waterborne materials, for SATA LP jet K3 spray mix, pre-assembled
144618	Fixing bolt D 15 - G 1/4
144626	Closing cap for SATA LP jet K3 spray mix
144642	Paint needle cpl. for SATA LP jet K3 spray mix, with needle sleeve

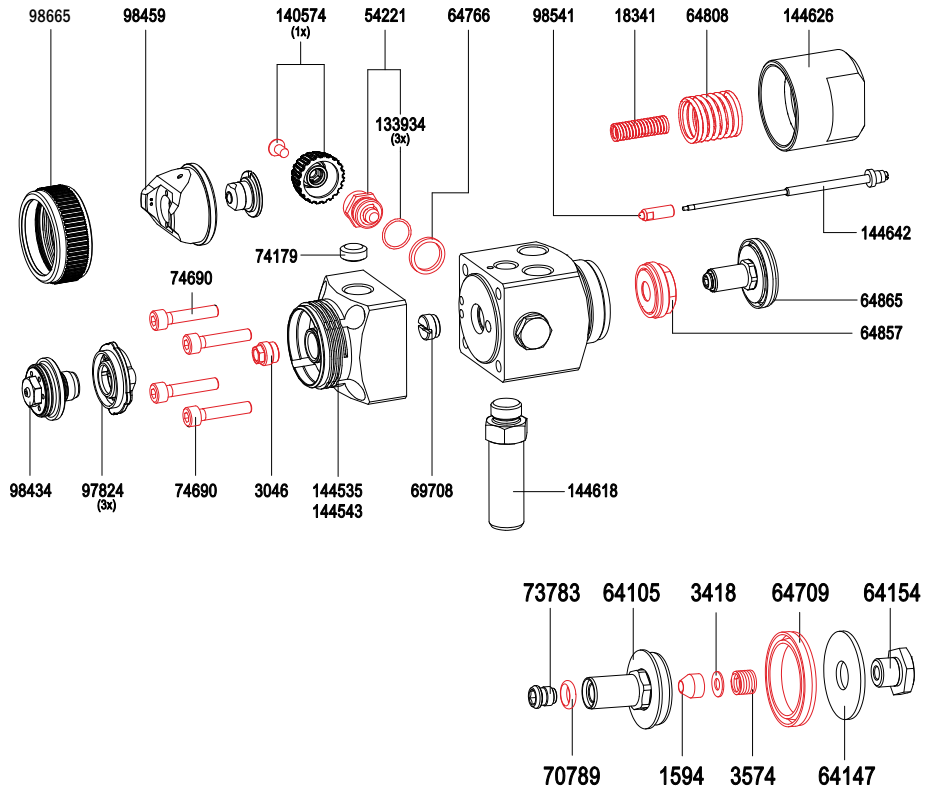

Art. No./Descr.	
14183	Tool kit
	<ul style="list-style-type: none"> Extraction tool Socket wrench SW 7 Cleaning brush Allen wrench 4 mm width Universal spanner

Art. No./Descr.	
144733	Repair kit LP jet K3 spray mix

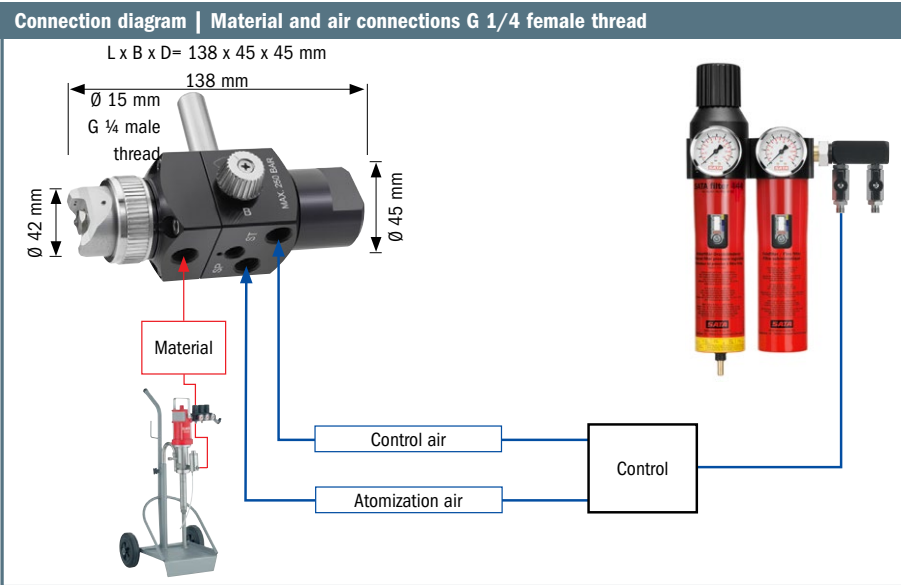

Technical modifications and printing errors reserved

SATAjet® Lab Test



SATAjet 5000 LAB RP				
Nozzle	1.2W	1.3	1.4	
Lab test spray gun with 0.6 l PVC reusable cup with spray pattern and test protocol				
Art. No.	224592	224576	224584	

SATAjet 5000 LAB HVLP				
Nozzle	WSB	1.3	1.4	
Lab test spray gun with 0.6 l PVC reusable cup with spray pattern and test protocol				
Art. No.	224568	224543	224550	

SATAjet 4000 LAB RP					
Nozzle	1.2	1.2W	1.3	1.4	1.6
Lab test spray gun with 0.6 l PVC reusable cup with spray pattern and test protocol					
Art. No.	182634	182659	182642	-	-
Nozzle set					
Art. No.	184903	184911	184895	198747	141374

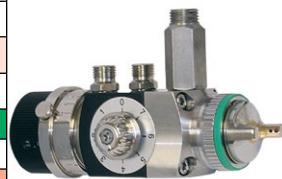

SATAjet 4000 LAB HVLP					
Nozzle	WSB	1.0	1.3	1.4	1.5
Lab test spray gun with 0.6 l PVC reusable cup with spray pattern and test protocol					
Art. No.	182618	219766	182626	-	-
Nozzle set					
Art. No.	184929	184937	198960	198754	

SATAjet 3000 LAB RP					
Nozzle	1.0	1.2	1.3	1.4	1.6
Lab test spray gun with 0.6 l PVC reusable cup with spray pattern and test protocol					
Art. No.	221218	118216	140368	157313	-
Nozzle set					
Art. No.	140871	119750	140350	141366	141374



SATAjet 3000 LAB HVLP					
Nozzle	WSB	1.3	1.5		
Lab test spray gun with 0.6 l PVC reusable cup with spray pattern and test protocol					
Art. No.	149633	148619	-		
Nozzle set					
Art. No.	-	148726	-		

SATAjet 2000 LAB HVLP				
Nozzle	WSB	1.3	1.5	
Lab test spray gun with 0.6 l PVC reusable cup with spray pattern and test protocol				
Art. No.	94821	90829	-	
Nozzle set				
Art. No.	141416	16485	16519	

SATA LP jet MSB LAB Test	
72595	SATA LP90 lab test spray gun, all material passages made of stainless steel, nozzle MSB 1.35, 0.6 l PVC cup, with spray pattern and test protocol
Nozzle sets	
72603	Nozzle set SATA LP90 lab test spray gun MSB 1.35 with test protocol and spray pattern
81786	Nozzle set SATA LP90 ROB lab test spray gun MSB 1.35 with test protocol and spray pattern

Technical modifications and printing errors reserved

Spare Parts SATAjet® Lab Test

Art. No./Descr.
1503
Countersunk screw M4 x 8 DIN 965, stainless steel, for micrometer und round/flat spray control
1594
Teflon seal for paint needle
1826
4 pieces non-drip devices for 0.6 l PVC cup
3418
Washer 3,7 DIN 125, brass
3574
Compression spring
3939
Spindle cpl. for LP90 lab test gun
11544
Compression spring for paint needle
19208
LP 90 regulation cap f. flexible material flow control, nickel-plated, ready for assembly
20057
Control screw for flexible material flow control
23911
Disc 3.2 DIN 125, nickel-plated, for trigger spray-mix
23960
Countersunk screw M 3 x 6, DIN 85 AM 3 x 6 4.8 galvanised
35873
Scale, anodised, with press cut holes
48231
Scale ring for LP90 test gun, nickel-plated, with black engraving
49379
Plastic gravity cup 0.6 l with lid
49395
Screw-on lid for 0.6 l PVC cup with drip-catching ring and non-drip device
49957
Scale plate
53819
Flexible compression piece M5 for stroke retainer HKD-ED DINOL and LP 90, made of stainless steel
64071
Seal retainer, cpl. w. needle packing (air side)
64105
Control piston for SATA LP, ready for assembly
64147
Washer for SATA LP90, ready for assembly
64154
Hollow screw for SATA LP90, ready for assembly
64709
Sleeve for SATA LP90
64766
Spacer
64808
Compression spring for SATA LP90
64857
Seal retainer LP90, big, complete, with piston packing
64865
Control piston for SATA LP90, cpl.
64873
End cap for LP90, complete
69997
Compression spring
70789
O-ring 5 x 2 mm, ethylene-propylene
73510
Spacer for LP90 lab test gun
73528
Blocking plate
73536
Control knob
73544
Intermediate washer for LP 90 test gun
73619
Reduction nipple for LP 90 test gun - version for water borne paints
73627
Index ring
73650
Threaded pin M2 x 3, DIN 554

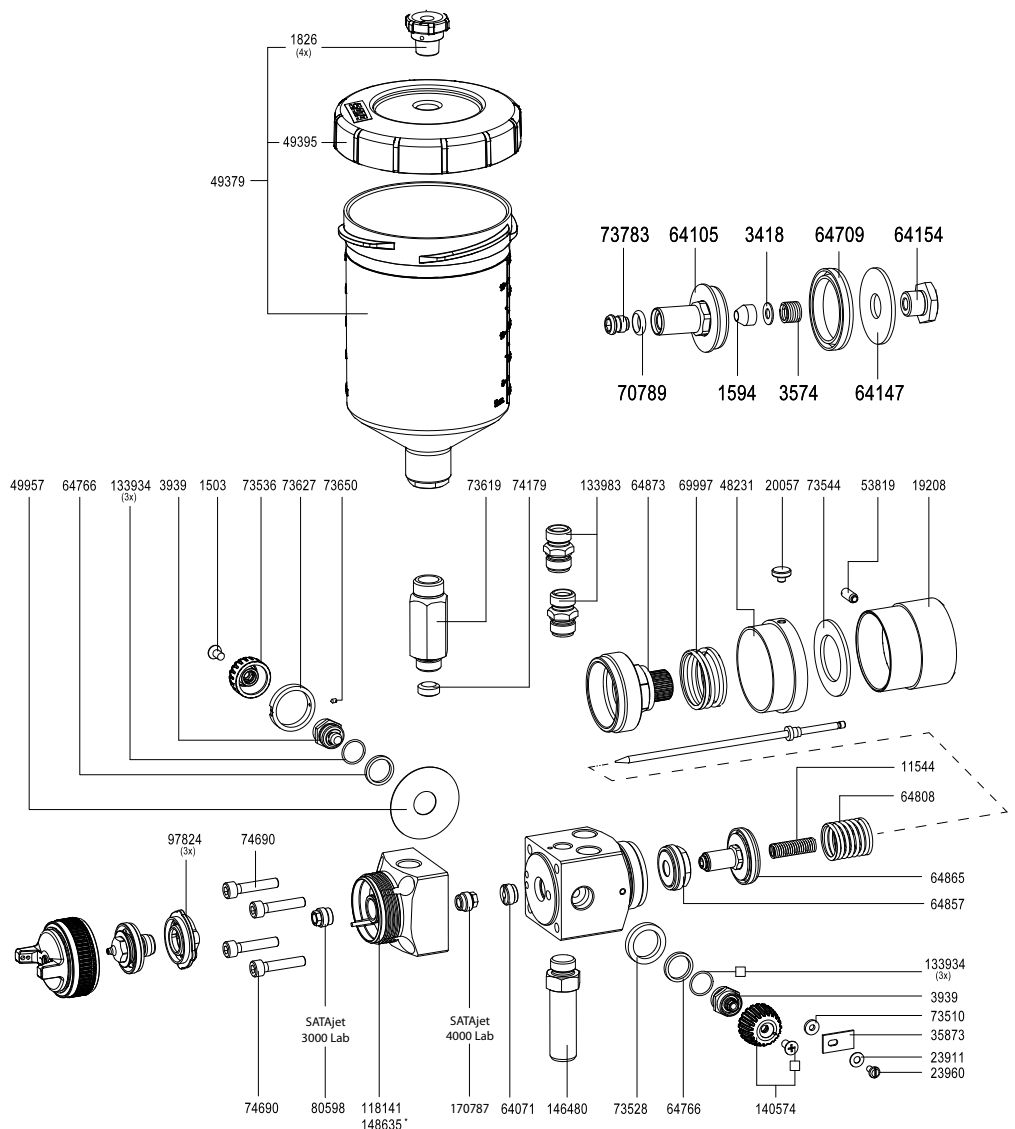

Art. No./Descr.
73783
Hexagonal socket-head screw for LP90
74179
Intermediate piece for LP90
74690
Cylindrical screw M5x25, A2 stainless steel, DIN 912, for LP90 guns (version for water borne paints)
80598
Seal retainer, cpl. w. 2 packings and metal ring, for paint needle 3.5 mm - material side
97824
Pack of 3 air distribution rings
118141
Nozzle head, cpl.
133934
Pack of 3 packings
133983
Air connection piece G1/4 male thread
140574
Control knob and screw (each 1)
146480
Fixing bolt D 14 - G 1/4
148635
Nozzle head, cpl.
170787
Seal retainer cpl. material side

14183 Tool Kit	
901	Universal spanner wrench
3509	Cleaning brush
43638	Extraction tool
71431	Allen wrench 4mm
76307	Socket wrench

Technical modifications and printing errors reserved





Cup Systems



SATA® RPS™



German Engineering



More information
may be obtained at:
www.sata.com/rps



SATA® RPS™ System



SATA RPS

Suitable for all paint materials! Please observe the recommendations of the paint manufacturers to choose the correct sieves (flat sieve 125 µ/200 µ and plug-in sieve 200 µ)

SATA RPS 0.3 | minijet

118299 SATA RPS 0.3 | minijet 125 µ flat sieve, 60-pk (SATAminijet 3000 B and earlier)



118414 SATA RPS 0.3 | minijet 200 µ plug-in sieve, 60-pk (SATAminijet 3000 B and earlier)



SATA RPS 0.3 | Standard sized guns

118281 SATA RPS 0.3 | 125 µ flat sieve, 60-pk



118406 SATA RPS 0.3 | 200 µ plug-in sieve, 60-pk



SATA RPS 0.6 |

125062 SATA RPS 0.6 | 125 µ flat sieve, 57-pk



125070 SATA RPS 0.6 | 200 µ plug-in sieve, 57-pk



151746 SATA RPS 0.6 | 200 µ flat sieve, 57-pk



SATA RPS 0.9 |

118471 SATA RPS 0.9 | 125 µ flat sieve, 40-pk



118489 SATA RPS 0.9 | 200 µ plug-in sieve, 40-pk



151720 SATA RPS 0.9 | 200 µ flat sieve, 40-pk



SATA RPS 0.6 | UV

139451 SATA RPS UV 0.6 | 125 µ flat sieve, 57-pk



139469 SATA RPS UV 0.6 | 200 µ plug-in sieve, 57-pk



Technical modifications and printing errors reserved

Spare Parts SATA® RPS™

Order No./Desc.
131961 80-pk spare lids for 0.6 l and 0.9 l cups
131979 100-pk 125µ blue flat sieves for 0.6 l and 0.9 l cups
131987 100-pk 200µ green plug-in sieves for all sizes
144964 100-pk 200µ green flat sieves for 0.6 l and 0.9 l cups
160606 60-pk 125µ blue flat sieves for 0.3 l cups
167908 90-pk spare lids for 0.3 l cups for standard guns

SATA RPS 0.3 l Standard

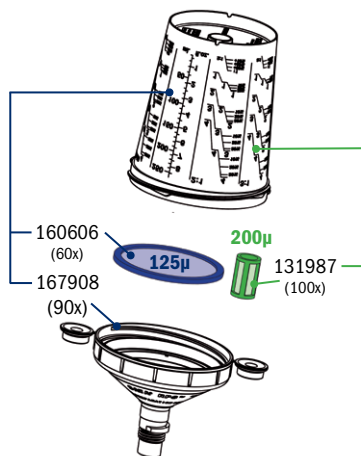

SATA RPS 0.3 l minijet (SATAMinijet 3000B and earlier)

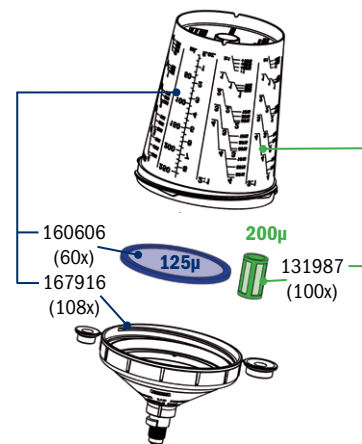

SATA RPS 0.6 l

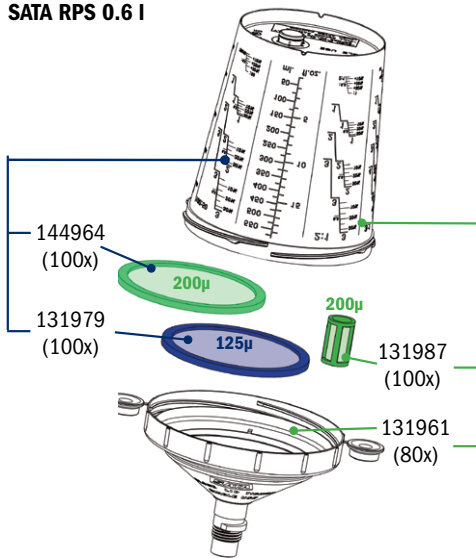



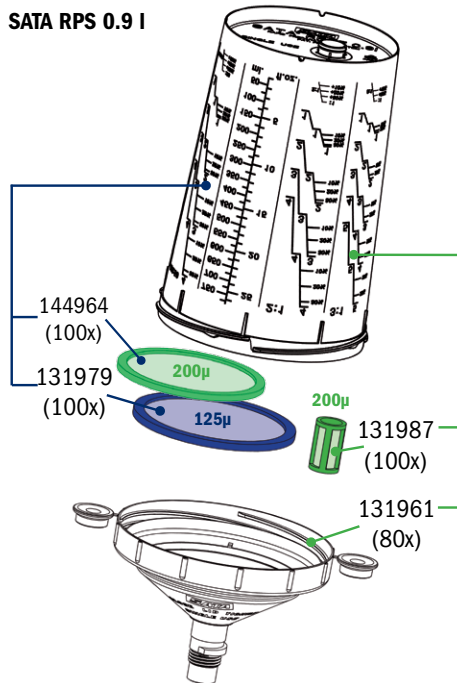









SATA RPS 0.9 l



Technical modifications and printing errors reserved

Accessories for SATA® RPS™

Accessories for SATA RPS		
192195	SATA universal spray gun and gun hose holder	
40188	SATA universal gravity gun holder for gravity flow cups	
9886	SATA wall mounted gravity gun holder	
127852	Cleaning solution bottle 1.0 l	
127860	Pressure pump spray bottle, 1.0 l	
127845	RPS 6-pack cup carrier	
139444	UV nozzle protectors, 5-pk	
165399	SATA RPS mix lid w/ 50 lids for RPS 0.6 l and 0.9 l (allows for stacking RPS cups)	 
173435 117051	Shaker ring for the 0.03 l Shaker ring for 0.06 l and 0.09 l	
170845	Disposable mixing stick for an effective mixing of paint components. Suitable for all waterborne and solvent borne paints Pack of 50	
144840	Rps Depot Storage rack to hold up to three RPS cup boxes (RPS cups not included)	

Technical modifications and printing errors reserved

SATA® RPS™ Adapter and Siphon Kits

Manufacturer	Spray Gun	Adapter	Part No.
SATA	SATAjet 2000 HVLP, RP w/o QCC	2	125237
	SATAjet LM 2000 HVLP/RP, SATAjet 90	2	125237
	SATAjet KLC HVLP/RP, KLC P	2	125237
	SATAjet B, NR 92, NR 95 HVLP	1	125211
	SATAjet LM B 92	7	133595
	SATAmijet, minijet 2, 3, 4	10	135798
	SATAjet 1000 H	16	188292
	SATAmijet 1000 H	17	188318
Binks	MG-1	3	125252
Airgunsa	AZ40 THE	4	125278
Asturo	OM Green	5	125294
3M/Graco	3M PPS	6	126326
DeVilbiss	PRI, GTI, GTI Pro, GFG, GFV, GFHV 510, Tekna, CVi	3	125252
	SRI	15	164608
Starting Line/	HLVP Spray Gun	13	150136
Finish Line	Mini Spray Gun	14	150151
Emininet	E13	4	125278
IWATA	W 400, WR 400, LPA 94	1	125211
	VXL Primer Gun, LPH 400, LPH 440	1	125211
	LPH 80	19	193276
	LS-400 (Super Nova), W 300, LPH 300	4	125278
	LPH100-LVG	12	147272
Kremlin	M 21 G	20	215079
Optima	800, 900	8	133827
Sagola	475 Mini-Gun	10	135798
	403 G, 433 G, 434 G, 444 G, 450 G	7	133595
	4100 G, 4200 G, 4300	7	133595
	4400	1	125211
	4400/4500 Xtreme	18	188664
Sharpe	GT1, Platinum, Titanium, Cobalt, SGF 98, Razor primer	9	135111
	Finex FX 300	8	133827
Walcom	FX GEO, FX HVLP	5	125294

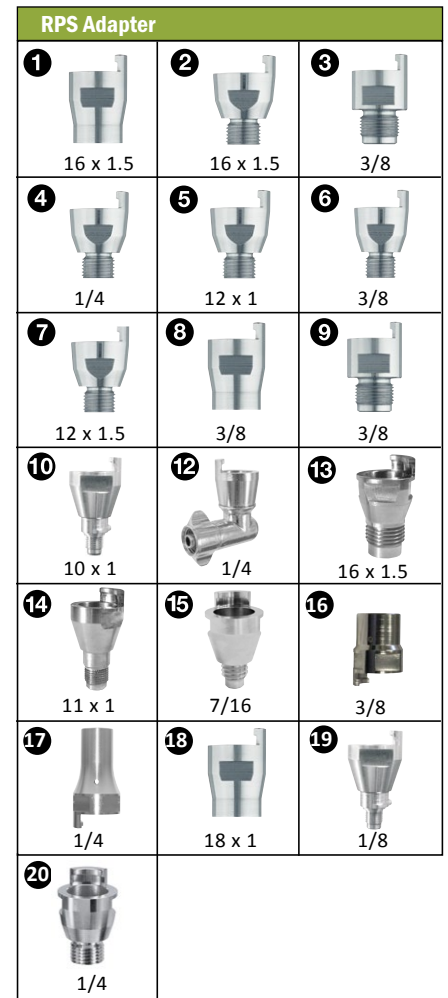





for updated adapter selections please visit www.satausa.com
 > encyclopedia
 > spray gun adapters

Siphon Kit for SATAjet H & SATAmijet 1000 H

188482	RPS Siphon Kit, pins, suction hose, sieve, (for 0.3L cup), pack of 25
188516	RPS Siphon Kit, pins, suction hose, sieve, (for 0.3L cup), pack of 50
188490	RPS Siphon Kit, pins, suction hose, sieve, (for 0.6L cup), pack of 25
188524	RPS Siphon Kit, pins, suction hose, sieve, (for 0.6L cup), pack of 50
188508	RPS Siphon Kit, pins, suction hose, sieve, (for 0.9L cup), pack of 25
188532	RPS Siphon Kit, pins, suction hose, sieve, (for 0.9L cup), pack of 50

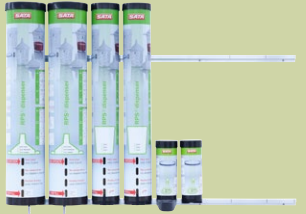

SATA® RPS™ Dispenser

SATA RPS Dispenser		
<p>All SATA RPS components have their defined place: cups, lids and sieves</p> <ul style="list-style-type: none"> ■ Allows to conveniently take out individual SATA RPS components ■ Filling level indication to ensure replenishment in due time ■ Re-filling is a swift process which only requires a quick removal of the tubes from the brackets 		
195784	<p>SATA RPS wall dispenser (basic kit) Standard kit for up to 2 cup sizes: 2 aluminum brackets for wall mounting, 2 tubes for cups, 2 tubes for lids, and 2 tubes for sieves</p>	
195776	<p>SATA RPS extension kit Extension kit for one additional cup size: 1 tube for cups, 1 tube for lids, and one tube for the sieves (the brackets of the standard kit are suitable for mounting the extension kit)</p>	
196543	<p>SATA RPS rotawall adapter kit Compact wall-mounting version: Wall bracket with rotating spindle to mount the basic version* and the extension kit*</p>	
196550	<p>SATA RPS rotafloor adapter kit Workbench/floor version: Height-adjustable stand with floor plate and rotating spindle to mount the basic version* and the extension kit*</p>	

* not included in the scope of delivery









RPS Dispenser Installation



www.youtube.com/watch?v=oag6778K2qM

Technical modifications and printing errors reserved

SATA® RPS™ Dispenser Parts





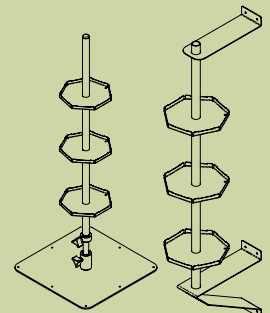





SATA RPS Dispenser Parts		
213629	RPS Fixing kit for tube. To repair dispenser tube, upper mounting bracket	
213637	RPS Cup holder only, for cup tube	
213645	RPS Brush only, Std. lid	
213652	RPS Brush only, mini lid	
213660	RPS Lid tube only, w/black lid	
213678	RPS Cup tube only, w/black lid	
213686	RPS Sieve tube, w/black lid	
215483	RPS Fixing bolts, for brushes	
215616	RPS Flat Sieve holder, large	









**for the
Rotaflow and
the Rotawall
Please
inquire
for spare
parts**



Technical modifications and printing errors reserved

SATA® Gravity and Siphon Cups for Spray Guns

Gravity flow cup							
Gun type		SATAjet 5000B, jet 4000 B, jet 3000 B, jet 1000 B, jet 100 B, jet 2000, jet RP, KLC, LM 2000 B Jet 90, Jet 90-2	SATAjet B, jet GR, jet NR 95	SATAminijet 4400 B	SATAminijet 3000 B, minijet 1 - 4, jet 20 B	SATAjet 20 B Dekor 2000	Lid
Capacity	Order No.						
Reusable Plastic cup							
2.2 oz. (63 ml)	15669				 use with adapter part no. 129346		15909
2.2 oz. (63 ml)	153551				 includes adapter No.129346		15909
3.0 oz. (85ml) QCC	165142	 use with adapter part no. 169326					95448
4.2 oz., (0.125 l) QCC	125443						95448
4.2 oz., (0.125 l) QCC	197541						199075
0.3 l	128470						121293
0.6 l	49379						49395
0.6 l	27243						49395

Gravity flow cup							
Gun type		SATAjet 5000B, jet 4000 B, jet 3000 B, jet 1000 B, jet 100 B, jet 2000, jet RP, KLC, LM 2000 B Jet 90, Jet 90-2	SATAjet B, jet GR, jet NR 95	SATAminijet 4400 B	SATAminijet 3000 B, minijet 1 - 4, jet 20 B		Lid
Capacity	Order No.						
Reusable aluminum cup							
0.15 l	125948						64022 Pk of 3
0.15 l	198911						64022-10 Pk of 10
0.75 l	6601						71555 Pk of 3
0.75 l	137729						
1.0 l	46631						
1.0 l	96685						

Technical modifications and printing errors reserved

Spare Parts

SATA® Aluminum and PVC Gravity Flow Cups for Spray Guns

Order No./Desc.	
1826	Non-drip device, pk of 4
3988	Sieve, pk of 20
3988-5	Sieve, pk of 5
6585	Insert, aluminum cup
27243	Cup, 0.6L QCC plastic, cpl
49395	Lid, 0.6L plastic
49437	Cup Lid Drip Ring, 0.6L, pk of 5
71555	Lid, plastic, pk of 3
96644	Nipple, QCC aluminum cup
96685	Cup, 1L QCC aluminum, cpl
96693	Ring, QCC marking
96719	Adapter, QCC to PPS cup
96875	Inner cup seal
137729	Cup, 0.75 L alum, cpl

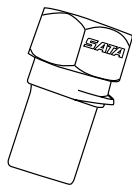
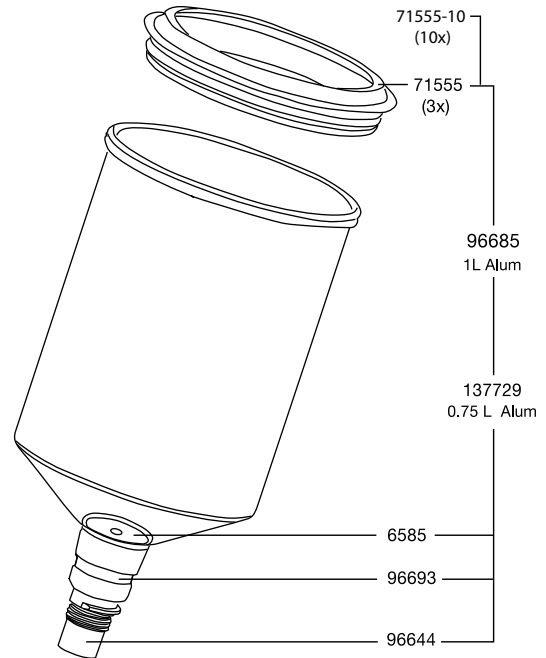
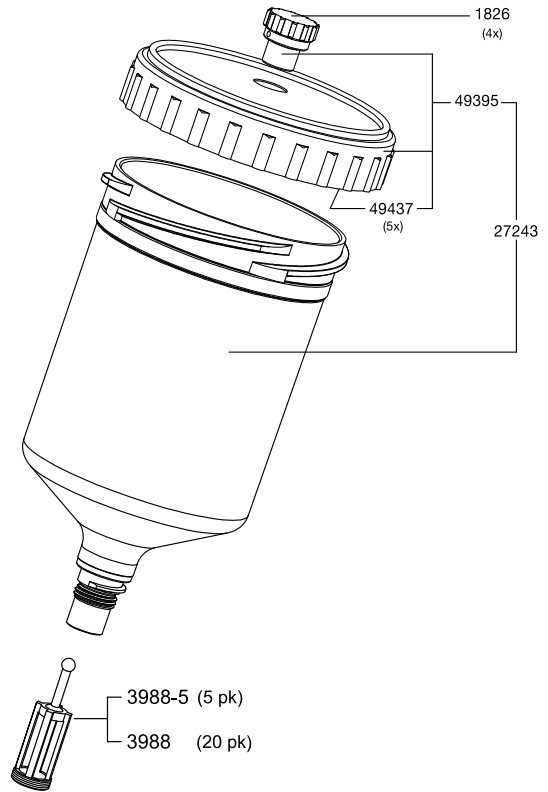











96719 QCC adapter, PPS Full size

Technical modifications and printing errors reserved

SATA® Siphon Cups and Cup Adapters

Aluminum Siphon cup					
Gun type		SATAjet 1000 H, Satajet H, LM 2000 H, GR/H-92, LM/H92 std SATAjet/H NR-92, SATAjet/H NR-95			
Capacity	Order No.				
Reusable Aluminum Siphon cup					
1.0 l	2691				

Glass cups					
Gun type		SATAminijet 4400 B	SATAminijet 2, 3, 4 SATAminijet 3000 B	SATA dekor SATAjet 20 B	
Capacity	Order No.				
Side mount glass siphon cups					
25 ml plug-in cup, each	16295	X	X	X	
25 ml plug-in cup, pk of 5	53033	X	X	X	
25 ml plug-in cup, pk of 5 w/ QCC & threaded plug-in adapter	125963	-	X	X	
25 ml plug-in cup, pk of 5 w/ QCC plug-in adapter	200238	X	-	-	
25 ml blind cup, each	16386	X	X	X	
25 ml blind cup, pk of 5	58164	X	X	X	

Cup Adapters		
96719	QCC cup adapter for PPS cup, full size guns	
125955	Plug-in cup connection with QCC SATAminijet (3000 B and earlier) SATAjet 20 B (dekor) cup adapter, glass siphon cups	
200220	Plug-in cup connection with QCC (std size) SATAminijet 4400 B	
129346	2.2 fl. oz. QCC cup adapter for SATAminijet 3000 B	
169326	3.0 fl. oz. QCC cup adapter for full size SATA guns	

Technical modifications and printing errors reserved

SATA® BVD Pressurized Cup System

SATA BVD Pressurized Cup System

25775	SATA BVD 0.75 aluminum pressure gravity cup for SATA spray guns - male and QC threads on cup, complete with air control regulator. For SATAJet 3000, jet 2000 HVLV, Jet RP, Jet 1000, Lm 2000
57505	SATA BVD 0.75 aluminum pressure gravity cup for SATA spray guns - female threads on cup, complete with air control regulator. For SATAjet B and GR/B-92

Part No./Description	
8268	Sealing ring
20412	Cup only, female threads
20438	Safety pressure relief valve, BVD
20461	Plastic air hose for BVD and agitator cup
21014	Aluminum lid, complete
21048	Pressure cup with lid
25577	Pressure cup with lid, QCC
29678	Cup only, QCC
53777*	Air connection for aluminum lid
54049	Sealing ring, (4x)
65920	Pressure regulator assembly
70664	Anti drip device, (10x)
83493	Connection for pressurize cup, complete
83501	Air hose cpl. dw/pressurized cup connection for SATA Spray-Master
120816	Pressure release screws (2x)
133983	Air connection piece G1/4 thread

*please also order 8268



Cup with lid

21048 for jet B
25577 for jet (QCC)

Cup only

29678 QCC
20412 Female threads
Jet/B, GR

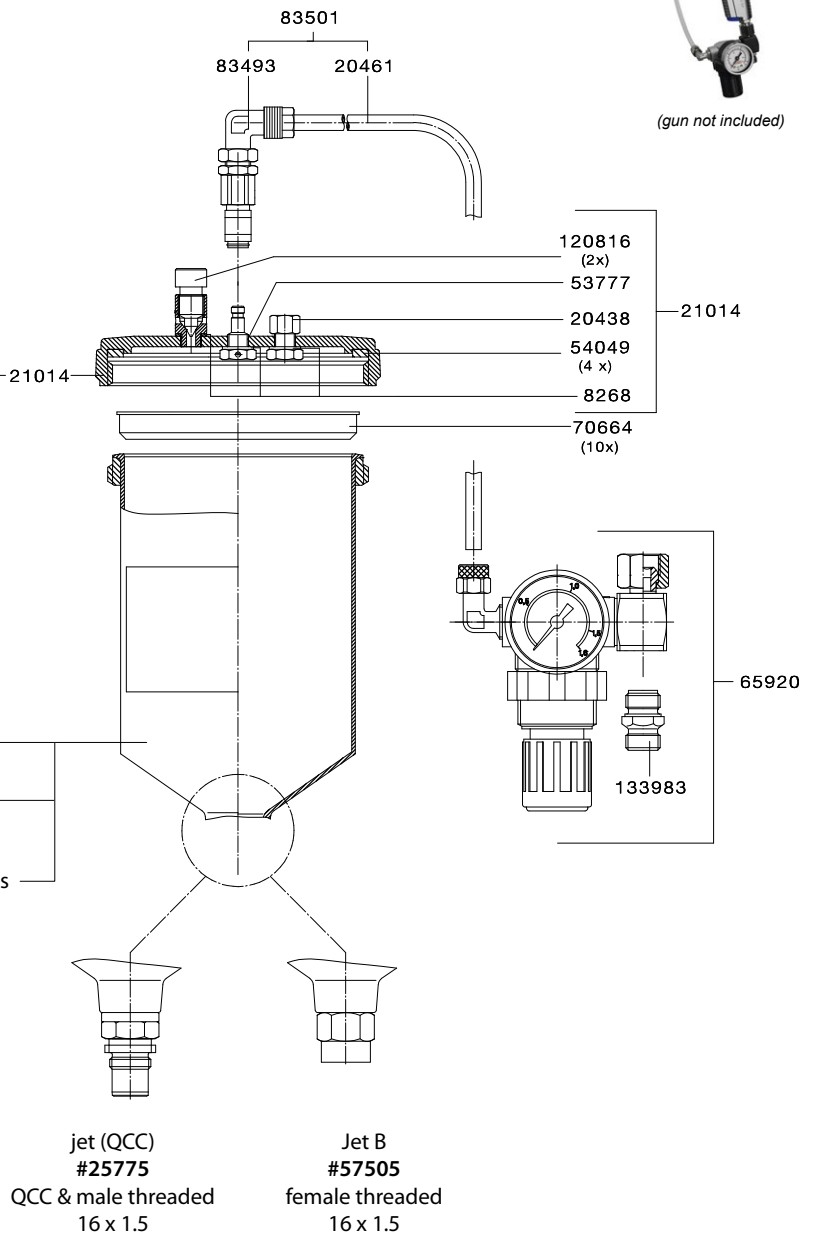

Technical modifications and printing errors reserved

SATA® Agitator Cup

SATA agitator cup	
9951	SATA agitator cup, female thread (on cup), 16 x 1.5, complete with regulator for SATAjet 3000, jet 2000 HVLP, Jet RP, jet 1000, LM 2000
29926	SATA agitator cup, QCC and male threads (on cup), 16 x 1.5, complete with regulator, for jet B, GR/B-92

Part No./Description	
1503	Countersunk screw M4 x 8 DIN 965, stainless steel, for micrometer round/flat spray control
1826	Anti-drip device (4x)
123513	Gauge, 0-145 PSI, SCAQMD face
2188	Air control for agitator regulator
20412	Cup only Jet/B GR
20461	Plastic air hose for BVD and agitator cup
21055	Agitating paddle for agitator cup
21063	Driving wing, cpl. with screw
21071	Gasket agitating vane, agitator cup
29678	Cup only QCC
44735	Countersunk screw, M 2.5 x 5 DIN 965
44743	Control knob
44792	Spindle
51078	Reg. Complete (for agitator cup)
53785	Angle screw socket, LCN-1/8-PL-4, f.
53793	Coupling with inner thread G 1/8 for SATA BVD
54049	Sealing ring (4x)
65557	Control knob

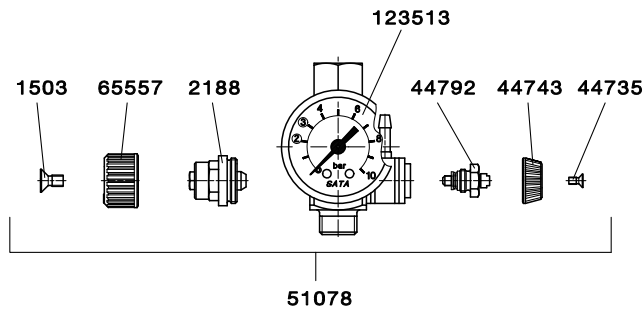
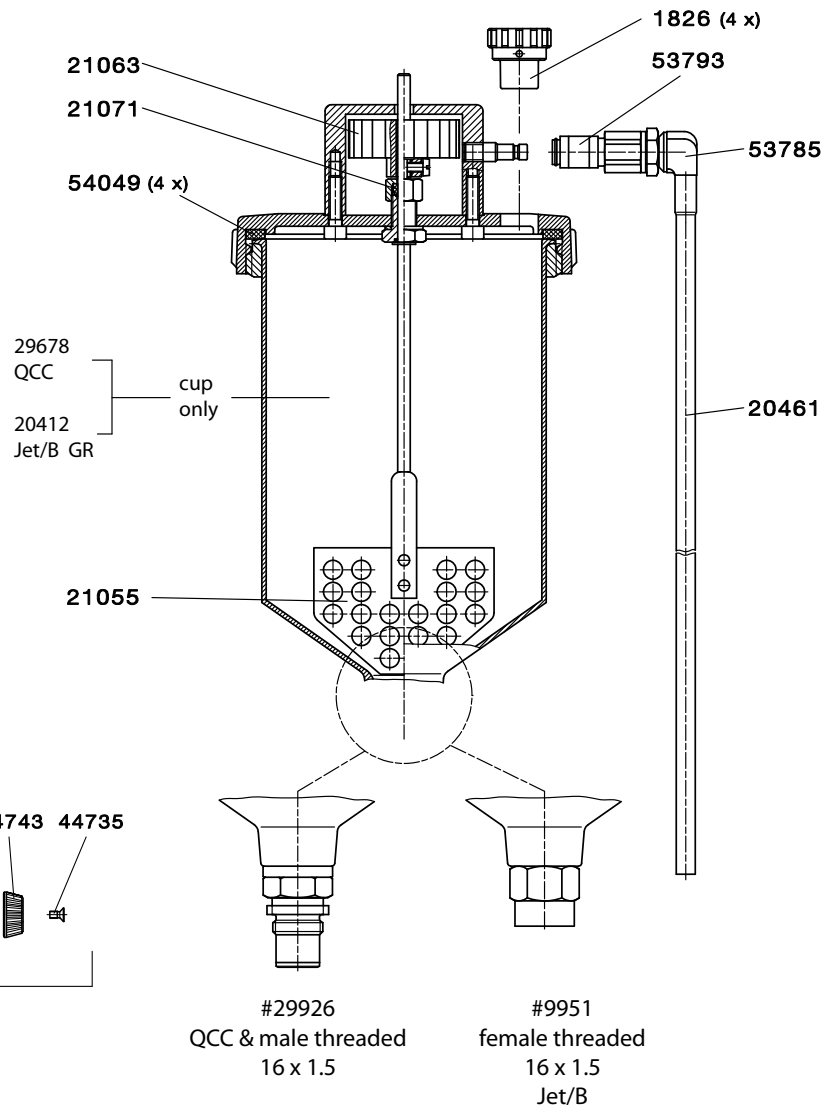
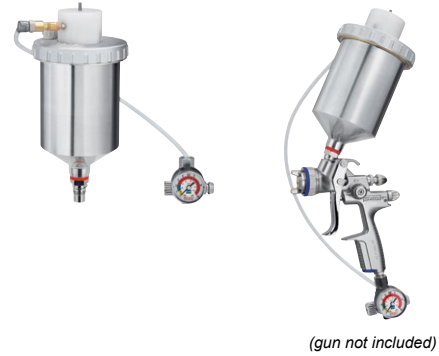

Technical modifications and printing errors reserved

Breathing Protection



Breathing Protection with Activated Charcoal Belt Unit

Air-fed full hood for use with double stage filter regulators eg: SATA 444



Basic Version w/ Activated Charcoal Belt Unit

Hood

SATA vision 2000 hood with breathing hose connection



36384 Hood and charcoal belt unit

Belt Unit

Activated Charcoal Belt Unit



Required Accessories

Non-gassing air hose connection from filter to belt
Various sizes available, see page 167

CO Monitors page 162

See page 114

Optional Accessories for Breathing Protection with or without Activated Charcoal Belt Unit.

Optional Accessories

Breathing air warmer

Infinitely adjustable breathing air warmer

Order No. 61242



Breathing air humidifier

Breathing air humidification for a comfortable breathing climate

Order No. 89086



Breathing Protection with Industrial Belt Valve



Air-fed full hood for use with triple stage filter regulators eg: SATA 484





See page 118

Basic Version w/ Industrial Belt Valve



<p>Hood SATA vision 2000 hood with breathing hose connection</p>		<p>60707 Hood and belt valve</p>
<p>Belt Unit Belt unit with industrial valve</p>		

Required Accessories
Non-gassing air hose connection from filter to belt
Various sizes available, see page 167
CO Monitors page 162

Basic Version w/ Activated Charcoal Belt Unit

<p>Mask SATA air star C half mask with breathing hose connection</p>		<p>137547 Mask and charcoal belt unit</p>
<p>Belt Unit Activated Charcoal Belt Unit</p>		

Basic Version w/ Industrial Belt Valve

<p>Mask SATA air star C half mask with breathing hose connection</p>		<p>137745 Mask and belt valve</p>
<p>Belt Unit Belt unit with industrial valve</p>		

Required Accessories
Non-gassing air hose connection from filter to belt
Various sizes available, see page 167
CO Monitors page 162

See page 116, 120

SATA air star C breathing protection half mask



SATA® vision™ 2000 with Activated Charcoal Belt Unit







Painting may generate excessive levels of overspray and solvent vapors. Some solvents cause poisonous toxic effects as they are absorbed into the bloodstream. Isocyanate hardeners are a specifically hazardous substance. The Type C continuous flow supplied air respirator with a full face shield provides complete protection for the eyes, skin and respiratory system.

The SATA vision 2000 NIOSH approval number is TC-19C-211. NIOSH approved respirators must be supplied with Type 1 Grade D air within the approved pressure range at the point of attachment of the respirator to the air delivery system. The activated charcoal belt unit is an auxiliary filter. Breathing air is filtered through activated charcoal. The activated charcoal purifies the air and removes any odor or hydrocarbon vapor. Air-flow is controlled with a throttle valve. A pressure gauge is mounted on the belt unit to visually monitor correct pressure setting.



SATA vision 2000 with charcoal belt unit

Technical Data	Operating pressure: 60-90 psi
	Air consumption: 6.3 - 11.3 cfm

Available versions

	<p>36384 The vision 2000 hood with SATA activated charcoal filter</p> <p>Vision 200 hood is a type C continuous flow supplied air respirator with full face shield. It is very comfortable to wear with an adjustable headband. Painters with reasonable beard length, mustaches or eyeglasses will appreciate the full hood protection with wide field of vision and single pane, non-glare anti-static visor. The hood is hygienic due to easily replaced linings and sweatband. It also features a tip-up visor making it unnecessary for the painter to remove the hood between coatings.</p> <p>NIOSH Approved</p>	
	<p>51854 SATA vision 2000 full hood respirator and full neck shield.</p>	
	<p>37200 SATA activated charcoal absorber belt unit is an auxiliary filter. Breathing air is filtered through activated charcoal. The activated charcoal purifies the air and removes any odor or hydrocarbon vapor. Airflow is regulated with a throttle valve. An airflow gauge is mounted on the belt unit to visually monitor correct airflow setting.</p>	
	<p>67595 SATA full hood respirator CE, head cloth and full neck shield</p> <p>The SATA hood is suitable for use when curing UV primers and clear coats which requires additional protection against UV light. Protects against UV light sources emitting wave lengths below 380 nm.</p>	

Accessories

<p>61242</p>	<p>SATA air warmer with air micrometer for SATA respirators</p>	
<p>89086</p>	<p>SATA top air breathing humidifier</p>	

Spare Parts SATA® vision™ 2000

vision 2000 Hood

Part No. 51854

Order No./Desc.	
10330	Sweat band, artificial leather, pk of 10
13854	Air silencer
21840	Visor pins, pk of 6
27821	Headband adjusting nut
30270	Hose clamp
35050	Visor tear off sheet, pk of 50
35100	Visor tear off sheet, pk of 100
35659	Visor tear off sheet, pk of 5
35675	Visor tear off sheet, pk of 25
36301	Visor tear off sheet, pk of 1000
47571	Sweat band, artificial leather, ea
51854	vision 2000 hood, complete
56184	Foam sleeve, only
56192	Air hose with foam sleeve
60541	Hood/chest cloth, gray, anti-static
61226	Headband, natural sheep leather, ea.
69658	White lining, pk of 20
75358	SATA hood cleaner, pk of 10
76299	Headband foam strip, w/adhesive
82594	Head piece with velcro
89243	Adjusting assembly, headband
89250	Headband, complete
89268	Nut assembly, headband
89268P	Pivot, headband adjusting, pk of 2
89276	Visor frame, complete
138735	Pivot, headband adjusting, pk of 10
164335	Sweat band, natural calf leather

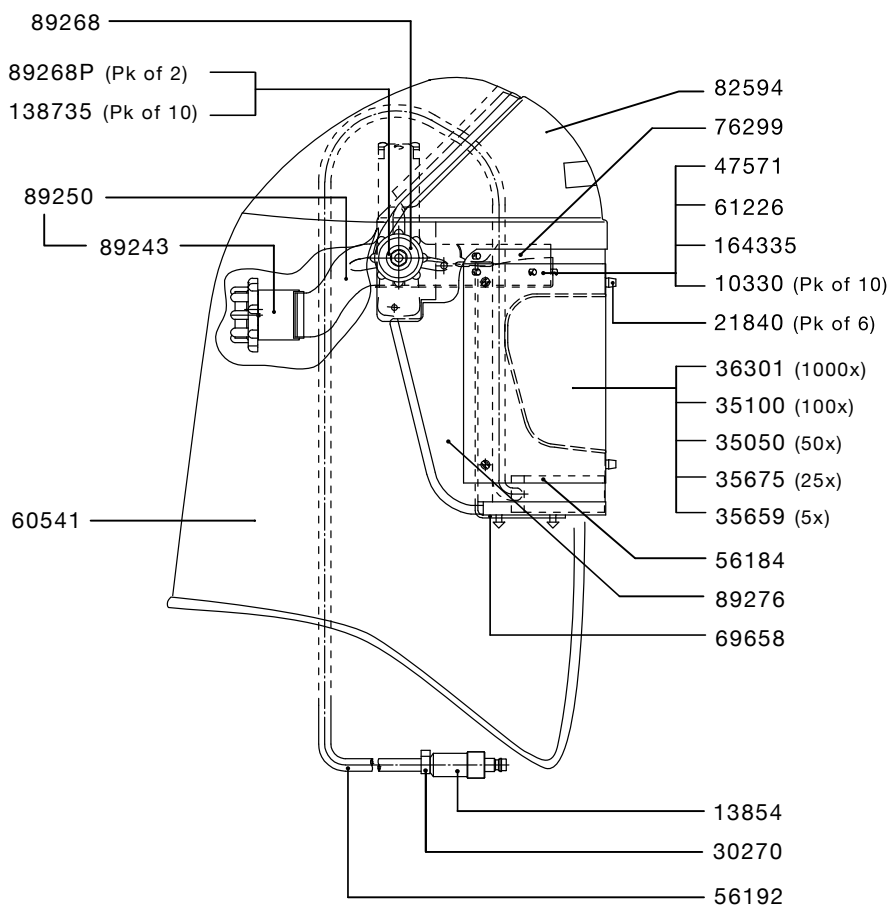

Charcoal Belt Unit, vision 2000

Part No. 37200

Order No./Desc.	
13904	Charcoal filter cartridge
13920	Waist belt only, no cushion
15412	Belt unit support straps
22947	O ring, housing
25171	Regulating valve, vision 2000
37200	Belt unit, complete vision 2000
37523	Gauge, vision 2000
49726	Protective filter cover
51110	T-Connection Kit, charcoal belt unit
51656	T-Connection only, charcoal belt unit
53934	Quick coupling
53942	Nipple
66852	Filter cover
149872	Belt cushion only

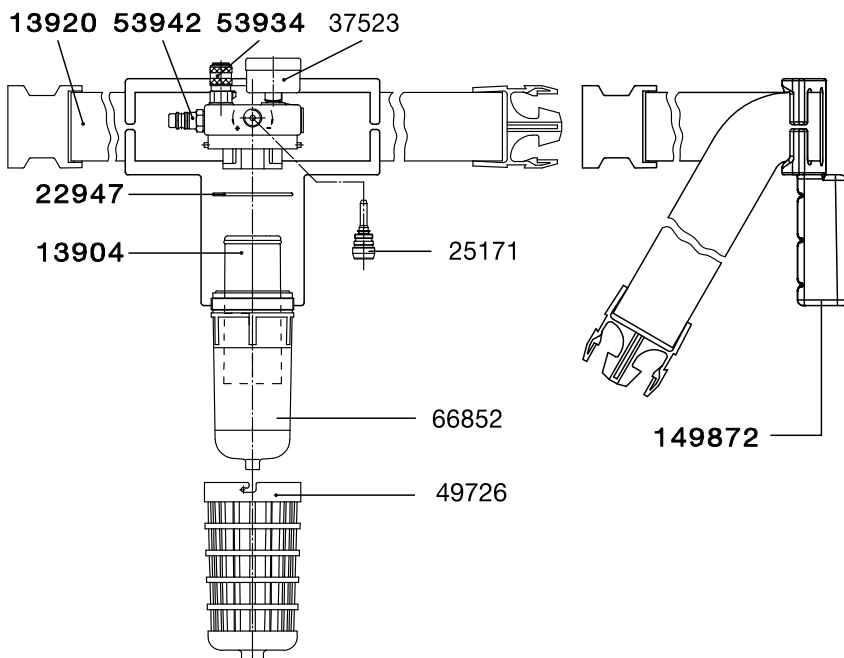

Technical modifications and printing errors reserved

SATA® air star C™ with Activated Charcoal Belt Unit







The SATA air star C™ half mask NIOSH approval number TC-19C-210. NIOSH approved respirators must be supplied with Type 1 Grade D air within the approved pressure range at the point of attachment of the respirator to the air delivery system. The activated charcoal belt unit is an auxiliary filter. Breathing air is filtered through activated charcoal. The activated charcoal purifies the air and removes any odor or hydrocarbon vapor. Airflow is regulated with a throttle valve. A pressure gauge is mounted on the belt unit to visually monitor correct airflow setting.



SATA air star C with charcoal belt unit

Technical Data	Operating pressure: 60 - 90 psi
	Air consumption: 5.6 - 13.4 cfm

Available versions

137547	<p>The SATA air star C and activated charcoal filter unit.</p> <p>The SATA air star C is a ventilated half-mask with adjustable continuous fresh-air supply. Body of mask made of natural rubber with anatomic formed sealing frame and matching nose seating. Built in exhausting valve. The SATA air star C half mask provides excellent vision with no internal heat buildup or moisture. The SATA air star C half mask offers a perfect face fit with four-point fixed head straps for seating the mask safely. Painters should bear in mind that half masks do not provide complete protection from dangerous Isocyanates that can be absorbed through the eyes and facial skin.</p> <p> NIOSH Approved</p>	
137653	SATA air star C respirator w/ breathing hose	
37192	Activated charcoal belt unit for air star C. SATA activated charcoal absorber belt unit is an auxiliary filter. Breathing air is filtered through activated charcoal. The activated charcoal purifies the air and removes any odor or hydrocarbon vapor. Airflow is regulated with a throttle valve. An airflow gauge is mounted on the belt unit to visually monitor correct airflow setting.	

Accessories

61242	SATA air warmer with air micrometer for SATA respirators	
89086	SATA top air breathing humidifier	

Spare Parts SATA® air star C™

SATA Air Star C half mask with air hose

Part Number 137653

Order No./ Desc.	
120469	Hose assembly, complete
120477	Air distribution foam, Pack of 2
134254	Head straps
134270	5-pk exhalation diaphragms + 10-pk inhalation diaphragms
137612	2-pk connections

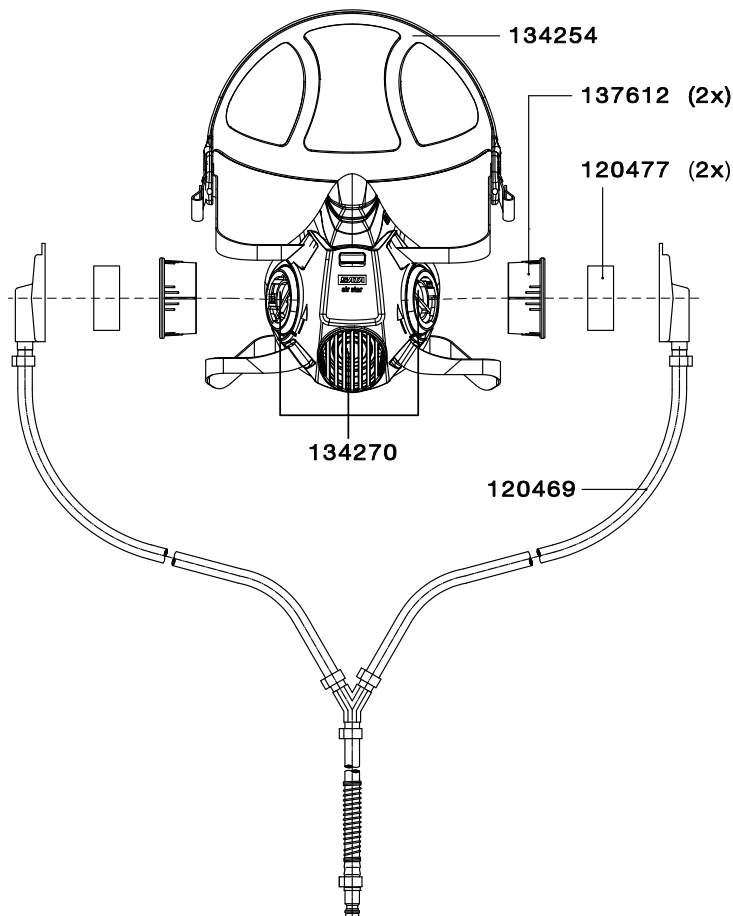

Charcoal Belt Unit, Half Mask

Part Number 37192

Order No./ Desc.	
13904	Charcoal filter cartridge
13920	Waist belt
15412	Belt unit support straps
22947	O ring, housing
25155	Regulating valve
37192	Belt unit, complete half mask
37507	Gauge, air pressure, HM belt unit
49726	Cover, protective filter
51110	T-Connection Kit, charcoal belt unit
51656	T-Connection only, charcoal belt unit
53942	Nipple, 1/4 male hi-flow
55640	52" Paint whip hose
67074	Filter cover
75176	Quick coupling, half mask
149872	Belt cushion only

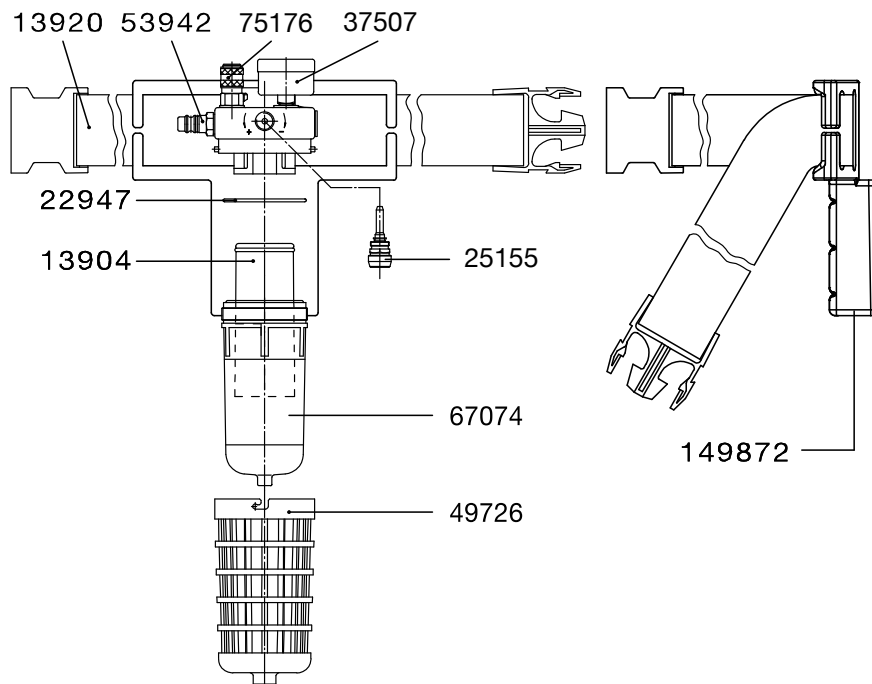

Technical modifications and printing errors reserved

SATA® vision™ 2000 with Industrial Belt Valve



Painting may generate excessive levels of overspray and solvent vapors. Some solvents cause poisonous toxic effects as they are absorbed into the bloodstream. Isocyanate hardeners are a specifically hazardous substance. The Type C continuous flow supplied air respirator with a full face shield provides complete protection for the eyes, skin and respiratory system.

The SATA vision 2000 NIOSH approval number is TC-19C-211. NIOSH approved respirators must be supplied with Type 1 Grade D air within the approved pressure range at the point of attachment of the respirator to the air delivery system. Airflow is controlled with a throttle valve.







SATA vision 2000 with belt valve

Technical Data



Operating pressure: 60 - 90 psi

Air consumption: 6.2 - 11.3 cfm

Available versions

<p>60707</p>  <p>NIOSH Approved</p>	<p>The SATA vision 2000 hood and SATA industrial belt valve. The SATA vision 2000 is a type C continuous flow supplied air respirator with full face shield. It is very comfortable to wear with an adjustable headband. Painters with reasonable beard length, mustaches or eyeglasses will appreciate the full hood protection with wide field of vision and single pane, non-glare anti-static visor. The hood is hygienic due to easily replaced linings and sweatband. It also features a tip-up visor making it unnecessary for the painter to remove the hood between coatings.</p>	
<p>51854</p>	<p>SATA vision 2000 full hood respirator only. The SATA vision 2000 is a type C continuous flow supplied air respirator with full face shield. It is very comfortable to wear with an adjustable headband. Painters with reasonable beard length, mustaches or eyeglasses will appreciate the full hood protection with wide field of vision and single pane, non-glare anti-static visor. The hood is hygienic due to easily replaced linings and sweatband. It also features a tip-up visor making it unnecessary for the painter to remove the hood between coatings.</p>	
<p>61002</p>	<p>SATA industrial belt valve for full hood The SATA industrial belt valve is to be used in conjunction with a triple stage filter with an activated charcoal filter, eg: SATA 484 Triple stage filter</p>	
<p>54825</p>	<p>SATA full hood respirator with cut-visor and full neck shield</p>	
<p>67595</p>	<p>SATA full hood respirator CE, head cloth and full neck shield The SATA hood is suitable for use when curing UV primers and clear coats which requires additional protection against UV light. The SATA hood, Art. No. 67595, is designed to protect against UV light sources emitting wave lengths below 380 nm,</p>	

Accessories

<p>61242</p>	<p>SATA air warmer with air micrometer for SATA respirators</p>	
<p>89086</p>	<p>SATA top air breathing humidifier</p>	

Technical modifications and printing errors reserved

Spare Parts SATA® vision™ 2000 and Ind. Belt Valve

vision 2000 Part No. 51854

Order No./Desc.	
10330	Sweat band, artificial leather, pk of 10
13854	Air silencer
21840	Visor pins, pk of 6
27821	Headband adjusting nut
30270	Hose clamp
35050	Visor tear off sheet, pk of 50
35100	Visor tear off sheet, pk of 100
35659	Visor tear off sheet, pk of 5
35675	Visor tear off sheet, pk of 25
36301	Visor tear off sheet, pk of 1000
47571	Sweat band, artificial leather, ea
51854	vision 2000 hood, complete
56184	Foam sleeve, only
56192	Air hose with foam sleeve
60541	Hood/chest cloth, gray, anti-static
61226	Headband, natural sheep leather, ea.
69658	White lining, pk of 20
75358	SATA hood cleaner, pk of 10
76299	Headband foam strip, w/ adhesive
82594	Head piece with velcro
89243	Adjusting assembly, headband
89250	Headband, complete
89268	Nut assembly, headband
89268P	Pivot, headband adjusting, pk of 2
89276	Visor frame, complete
138735	Pivot, headband adjusting, pk of 10
164335	Sweat band, natural calf leather

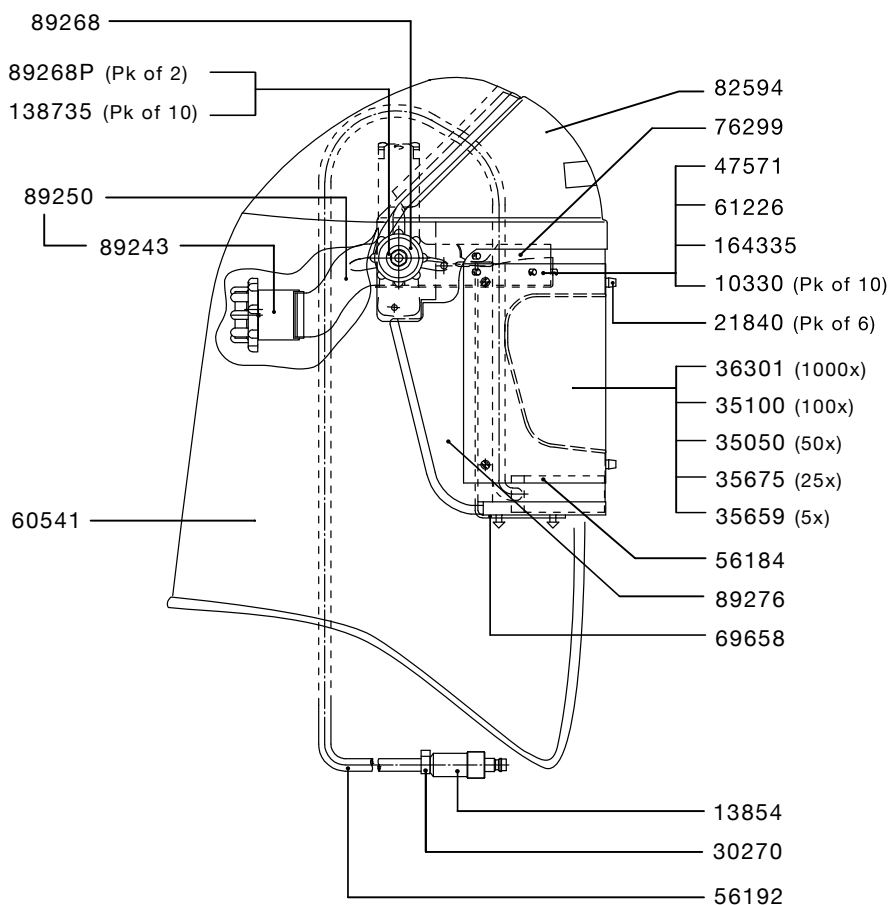

Industrial belt valve Part No. 61002

Order No./Desc.	
1503	Air control screw
13656	Female threaded nipple
13920	Waist belt
53934	Nipple, 1/4 male
54221	Fan control
54908	L Bracket
61002	Belt valve complete, vision 2000
65557	Knob, fan control
149872	Belt cushion only, foam
671070	T fitting, (supplied separately)

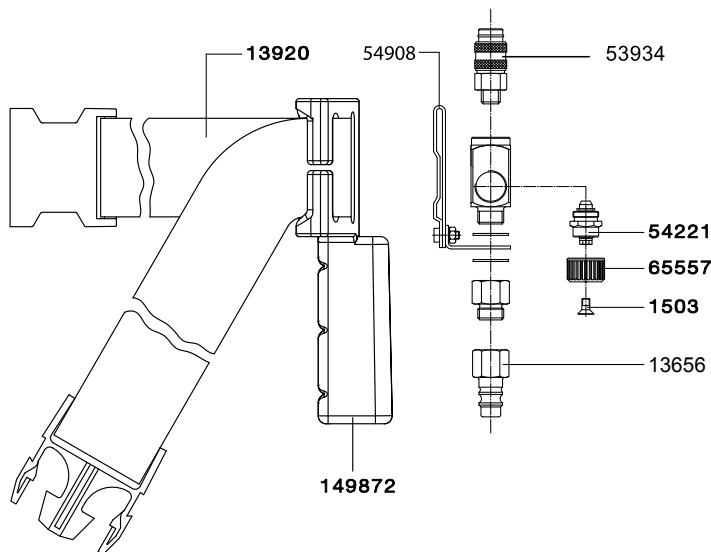

Technical modifications and printing errors reserved

SATA® air star C™ with Industrial Belt Valve



The SATA air star C™ half mask NIOSH approval number TC-19C-210. NIOSH approved respirators must be supplied with Type 1 Grade D air within the approved pressure range at the point of attachment of the respirator to the air delivery system. Airflow is regulated with a throttle valve.

SATA air star C with belt valve

Technical Data

Operating pressure: 60 – 90 psi

Air consumption: 4.4 – 12.7 cfm

Available versions

137745

The SATA air star C is a NIOSH approved ventilated half-mask with adjustable continuous fresh-air supply. Body of mask made of natural rubber with anatomic formed sealing frame and matching nose seating. Built in exhausting valve. The SATA air star C half mask provides excellent vision with no internal heat buildup or moisture. The SATA air star C half mask offers a perfect face fit with four-point fixed head straps for seating the mask safely. Painters should bear in mind that half masks do not provide complete protection from dangerous Isocyanates that can be absorbed through the eyes and facial skin.

SATA air star C does not need to be form fit.

NIOSH Approved



137653

SATA air star C respirator with breathing hose



138362

SATA industrial belt valve for half mask

The SATA industrial belt valve is to be used in conjunction with a triple stage filter with an activated charcoal filter, eg: SATA 484 Triple stage filter



Accessories

61242

SATA air warmer with air micrometer for SATA respirators



89086

SATA top air breathing humidifier



Spare Parts SATA® air star C™ and Ind. Belt Valve

SATA Air Star C half mask with air hose Part Number 137653

Order No./Desc.	
120469	Hose assembly, complete
120477	Air distribution foam, pack of 2
134254	Head straps
134270	5-pk exhalation diaphragms + 10-pk inhalation diaphragms
137612	2-pk connections

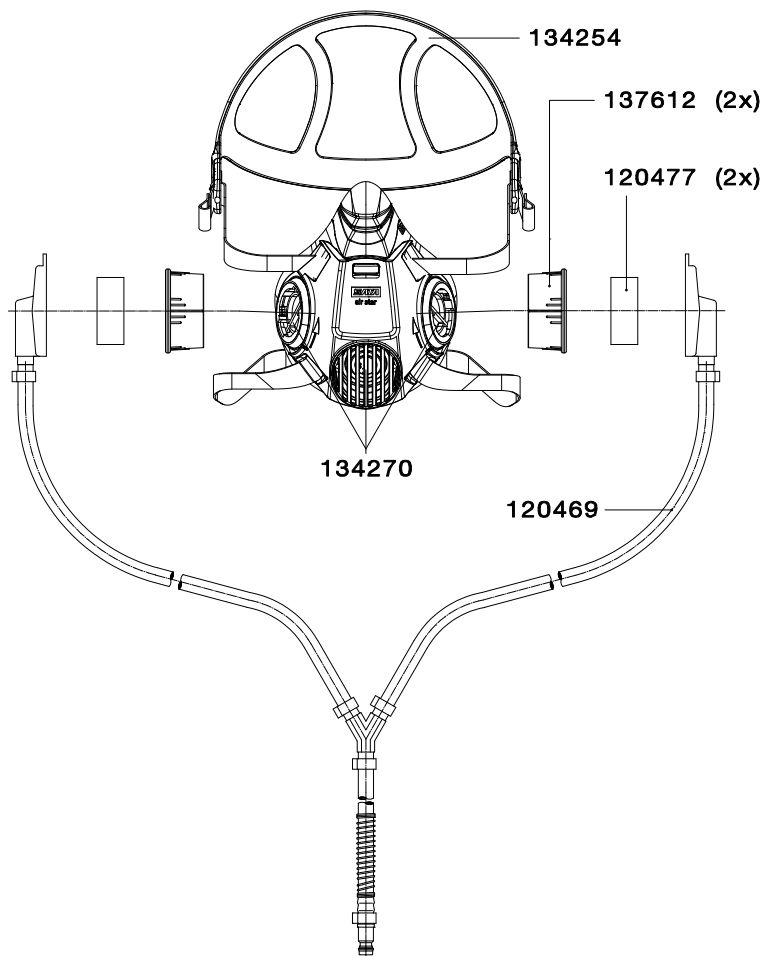





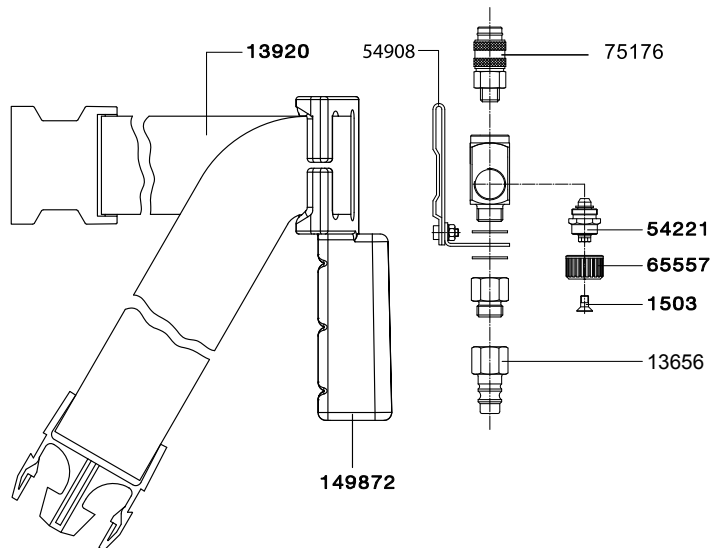







Industrial belt valve Part No. 138362

Order No./Desc.	
1503	Air control screw
13656	Female threaded nipple
13920	Waist belt
53934	Nipple, 1/4 male
54221	Fan control
54908	L Bracket
65557	Knob, fan control
66852	Filter cover
138362	Belt valve complete, half mask
149872	Belt cushion only, foam
671070	T fitting, (supplied separately)



Technical modifications and printing errors reserved

Accessories for Vision 2000/Air star C, Top air humidifier

Accessories for Belt Units		
13904	Activated charcoal filter cartridge for both full hood and half mask belt units. Recommend change interval is every 3 months.	
15412	Belt unit support straps, suspenders	
Accessories for all supplied air respirators		
89086	SATA top air breathing humidifier	
81158	Complete cartridge module for SATA top air humidifier	
61242	SATA air warmer with air micrometer for SATA respirators	
Cleaning Cloths		
75358	10-pk disinfecting tissues for SATA respirators	
Accessories for SATA vision 2000		
56762	Hood cloth only, gray industrial, for SATA vision 2000, with neck and chest protection	
35659	Tear off visor sheets, vision 2000, pack of 5	
35675	Tear off visor sheets, vision 2000, pack of 25	
35050	Tear off visor sheets, vision 2000, pack of 50	
35100	Tear off visor sheets, vision 2000, pack of 100	
36301	Tear off visor sheets, vision 2000, pack of 1000	
69658	Hygienic hood lining, vision 2000	
10330	Head band lining, artificial leather, vision 2000, pack of 10	
47571	Head band lining, artificial leather, vision 2000	
61226	Head band lining, natural leather (sheep), vision 2000	
164335	Head band lining, natural leather (calf), vision 2000	
Breathing Hoses available lengths 10-100 ft. See page 167		
CO Monitors for options see page 162		

Spare Parts SATA® top air™

SATA top air, 2011

Order No./Desc.	
24505	Safety quick coupling
24612	Nipple
24620	Head gasket
24919	O ring, module
24950	Safety valve, complete
46169	Threaded nipple
53975	Hose clamp, 10.5
63214	Screw, filling cap
70789	O ring, filling cap
72611	Valve, complete
81158	Cartridge
82917	Air hose
86777	Head
86785	Receptacle
97311	Hose, PVC (cut to length)
163535	Holder
163543	Container with acme thread
176420	O-Ring 68 x 2.0 (before July 2013)
199729	O-Ring 71 x 2.0 (after July 2013)

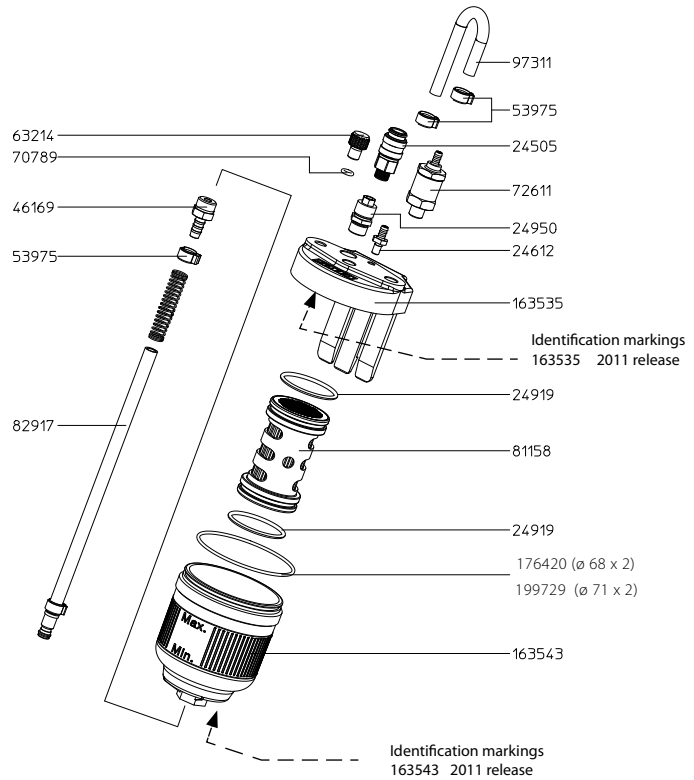

SATA top air, pre 2011

All parts not listed are common to the new version

Order No./Desc.	
24620	Head gasket
70789	O ring, filling cap
82917	Air Hose
86777	Head NLA
86785	Receptacle NLA

NLA = No Longer Available

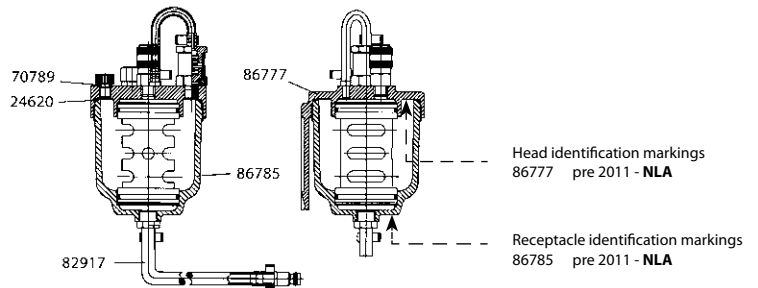

SATA air warmer

New and old version

Order No./Desc.	
1503	Screw, fan control
11551	O Ring
29413	Stainless steel nipple
53934	Safety quick coupling
61242	Air warmer with adjusting valve
65557	Knob, fan control

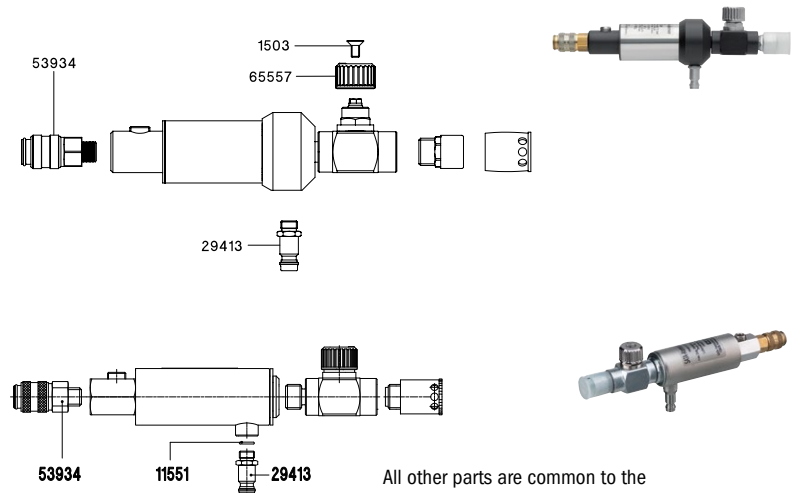



All other parts are common to the newer version if not indicated

Technical modifications and printing errors reserved



SATA® air star F™



Filtering mask for short usage periods during small paint jobs

SATA air star F		
134353	SATA air star F, filter A2:P3 R D, 2 pre-filter holders and 10 pre-filters	
134288	SATA air star F, filter A2:P3 R D, 2 pre-filter holders and 10 pre-filters with hygiene box	

Accessories		
75358	10-pk disinfecting tissues for SATA respirators	

Spare Parts for SATA air star F		
134262	10-pk pre-filters for SATA air star F	
134239	50-pk pre-filters for SATA air star F	
134296	1 pair special filter A2:P3 R D for SATA air star F	
134312	3 pair special filter A2:P3 R D for SATA air star F	
134304	6 pair special filter A2:P3 R D for SATA air star F	
134247	2 pre-filter holders (red) and 10 pre-filters for SATA air star F	

Technical modifications and printing errors reserved



Filtration



SATA® filter 414™/ 424™/ 434™/ 464™

SATA filter 414/424/434/464

Technical Data

Air inlet: G1/2, female thread
Air outlet: G1/2, female thread and/or G 1/4 male thread
Max. inlet operating pressure: 15.0 bar / 217 psi
Max. outlet operating pressure: 10.0 bar / 145 psi
Air flow at 6.0 bar: 3,600 NI/min / 129 cfm @ 90 psi
Max. ambient temperature: 248° F
Max. ambient temperature w/ activated charcoal: 140° F



Pressure Regulator/water separator

92288	SATA 420 Line Pressure Regulator High air volume of 141 cfm, up to 225 psi inlet, G 1/2 internal inlet & outlet thread	
92213	SATA filter 414 5 micron oil / water separator with automatic condensation discharge, with ball valve air connection module but without regulator. 1/2 inch internal inlet thread and two 1/4 inch external outlet thread. (2 x G 1/4 male thread)	
92254	SATA filter 414L (in-line) 5 micron oil / water separator with automatic condensation discharge, in-line installation. 1/2 inch internal inlet/outlet thread. (G 1/2 female thread)	
92221	SATA filter 424 5 micron oil / water separator unit with automatic condensation discharge, pressure regulator and ball valve air connection module. 1/2 inch internal inlet thread and two 1/4 inch external outlet thread. (2 x G 1/4 male thread)	
92262	SATA filter 424 L (in-line) 5 micron oil/water separator unit with automatic condensation discharge and pressure regulator. 1/2 inch internal inlet/outlet thread.	

Fine filter

92239	SATA filter 434 0.01 micron filter unit with ball valve air connection module. Provides 99.998% clean air. Compressed air must be pre-filtered when using this unit. 1/2 inch internal inlet thread and two 1/4 inch external outlet thread. (2 x G 1/4 male thread)	
92270	SATA filter 434L (in-line) 0.01 micron filter unit. Provides 99.998% clean air. Compressed air must be pre-filtered when using this unit. 1/2 inch internal inlet/outlet thread.	

Activated charcoal filter

92247	SATA filter 464 Single-stage activated charcoal filter, with outlet module (2 x G 1/4 male thread)	
141473	SATA filter 464A Add-on unit with fittings without module. To retrofit SATA filter 444 to 484	
92247L	SATA filter 464L (in-line) Line filter unit without fitting and module.	

Technical modifications and printing errors reserved

Spare Parts SATA® filter 414™/ 424™/ 434™/ 464™

Order No./ Desc.

2949	Diaphragm
15511	Auto. condensate valve only
22046	Pressure gauge
22087	"O" ring
22129	Teflon ball valve
22137	Cyclone tube
22152	"O" ring
22160	Sintered bronze filter
23804	Pressure valve, complete
24471	PVC nut with "O" rings
24489	Mounting rod with pressure valve
24521	Baffle with "O" ring
24554	Housing tube with auto. cond. valve
24562	Adapter with "O" ring
28506	"O" ring
28514	"O" ring
73890	Threaded rod
80457	Spindle, complete
81810	Fine filter
84749	"O" ring, 33 x 2
84871	Housing Tube, 2nd Stage
85142	"O" ring, 30 x 1.5
85373	Activated charcoal cartridge
94979	Repair kit, 400
95000	Union fitting, 1/2"
95851	Countersunk screw
96578	Valve housing
96750	Packing Kit
96883	Regulator adjusting knob
158808	Manifold, 2 drop

SATA filter 424

● Stage 1

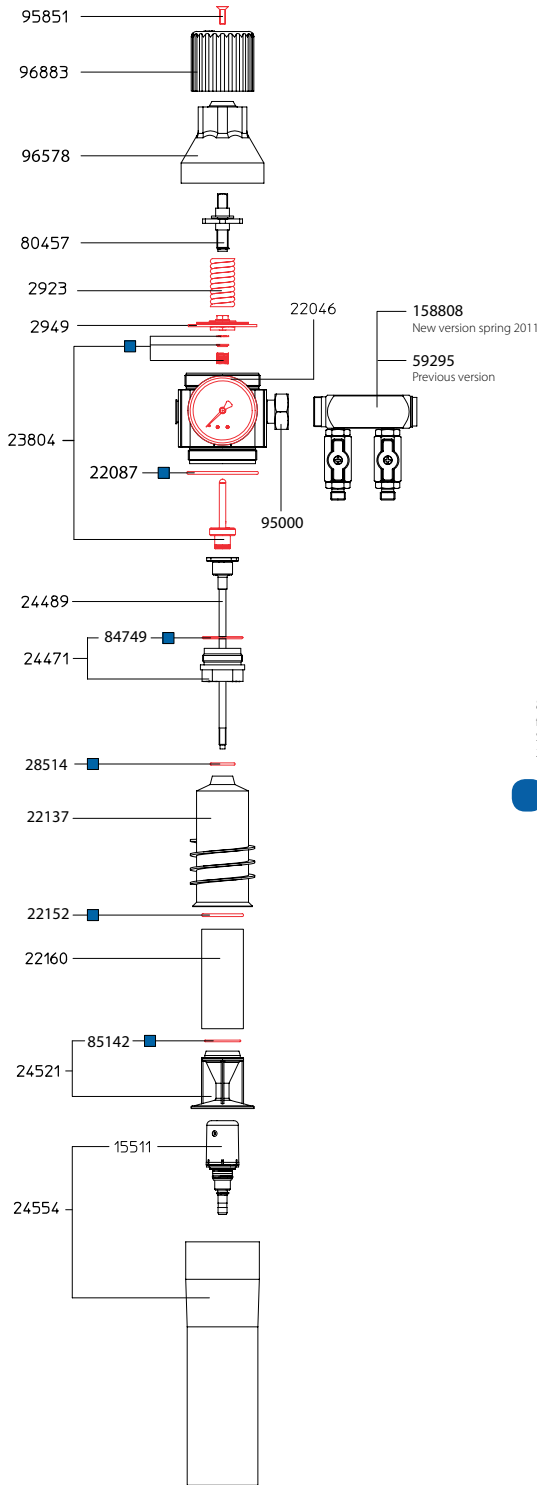

SATA filter 434

● Stage 2

SATA filter 464

● Stage 3

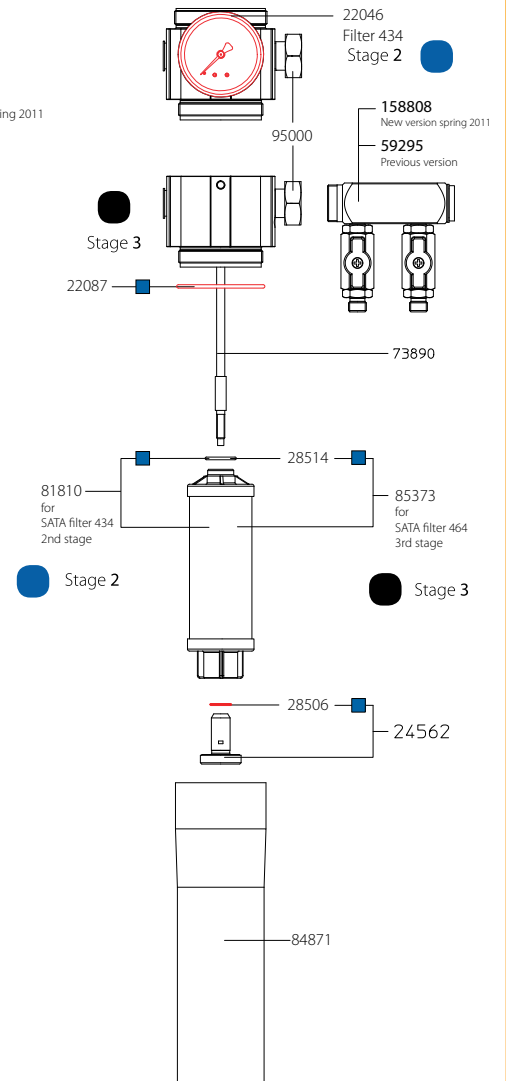

Order No./ Desc.

94979	Repair kit
96750	Packing set

Technical modifications and printing errors reserved

SATA® filter 444™/ 484™

The SATA 400 modular filter series is designed to meet the highest standards of quality and performance. The modular system allows the user to adapt to varying shop conditions and requirements. Easy to service and maintain with no desiccant related problems. Dual gauge monitor pressure differential, thus a pressure variation of 10 to 15 psi or more indicate filter maintenance is required.

- High air volume capacity of 129.6 cfm at 90 psi
- Fully automatic condensation discharge
- Anti-corrosion proof
- Temperature resistant up to 248° F (charcoal units up to 140° F)
- No desiccant maintenance
- Rugged all metal housing for long service life







SATA combination filter systems are especially suitable for use with supplied air respirators providing 100% (technically 99.998%) clean breathing air.

SATA filter 400

Technical Data

Air inlet: G 1/2 internal	Air flow at 6.0 bar: 3,600 NI/min / 129 cfm @ 90 psi
Air outlet: G 1/2 internal and/or G 1/4 external	Max. ambient temperature: 248° C
Max. inlet operating pressure: 15.0 bar / 217 psi	Max. ambient temperature w/ activated charcoal: 140° F
Max. outlet operating pressure: 10.0 bar / 145 psi	Air flow at 6.0 bar: 3,600 NI/min / 129 cfm @ 90 psi

Combination Filter

92296	SATA filter 444 Double-stage sinter filter/fine filter with pressure regulator and outlet module (2 x G 1/4 male thread)	
92296-4	With 4 drop manifold	
92833	SATA filter 444 with floor carrying support	
28076	Stand only	
92296L	SATA filter 442 (in-line) Inline version of the SATA 444, double stage filter unit No regulator or manifold. 1/2" internal inlet & outlet threads	
92320	SATA 484 filter Triple-stage sinter filter/fine filter/activated charcoal filter with pressure regulator and outlet module (2 x G 1/4 male thread)	
92320-4	With 4 drop manifold	
92320L	SATA 482 filter (in-line) In-line version of the SATA 484 triple stage filter unit. No regulator or manifold. 1/2 inch internal inlet and outlet threads	

Spare Parts SATA® filter 444™/ 484™

Order No./Desc.	
2923	Spring
2949	Diaphragm
15511	Auto condensate valve only
22046	Pressure gauge
22087	"O" ring
22129	Teflon ball valve
22137	Cyclone tube
22152	"O" ring
22160	Sintered bronze filter
23804	Pressure valve, complete
24471	PVC nut with "O" rings
24489	Mounting rod with pres. valve
24521	Baffle with "O" ring
24554	Housing tube with auto. cond. valve
24562	Adapter with "O" ring
28506	"O" ring
59295	Outlet manifold, std
73890	Threaded rod
78360	Seal
80457	Spindle, complete
81810	Fine filter
84749	"O" ring, 33 x 2
84871	Housing Tube, 2nd Stage
85142	"O" ring, 30 x 1.5
85373	Activated charcoal cartridge
92163	Mounting bolt, 0/400
92569	Wall mounting kit (not illus.)
94979	Repair kit, 400
95000	Union fitting, 1/2"
95851	Countersunk screw
96578	Valve housing
96883	Regulator adjusting knob
158808	2 drop manifold, 2011 and after

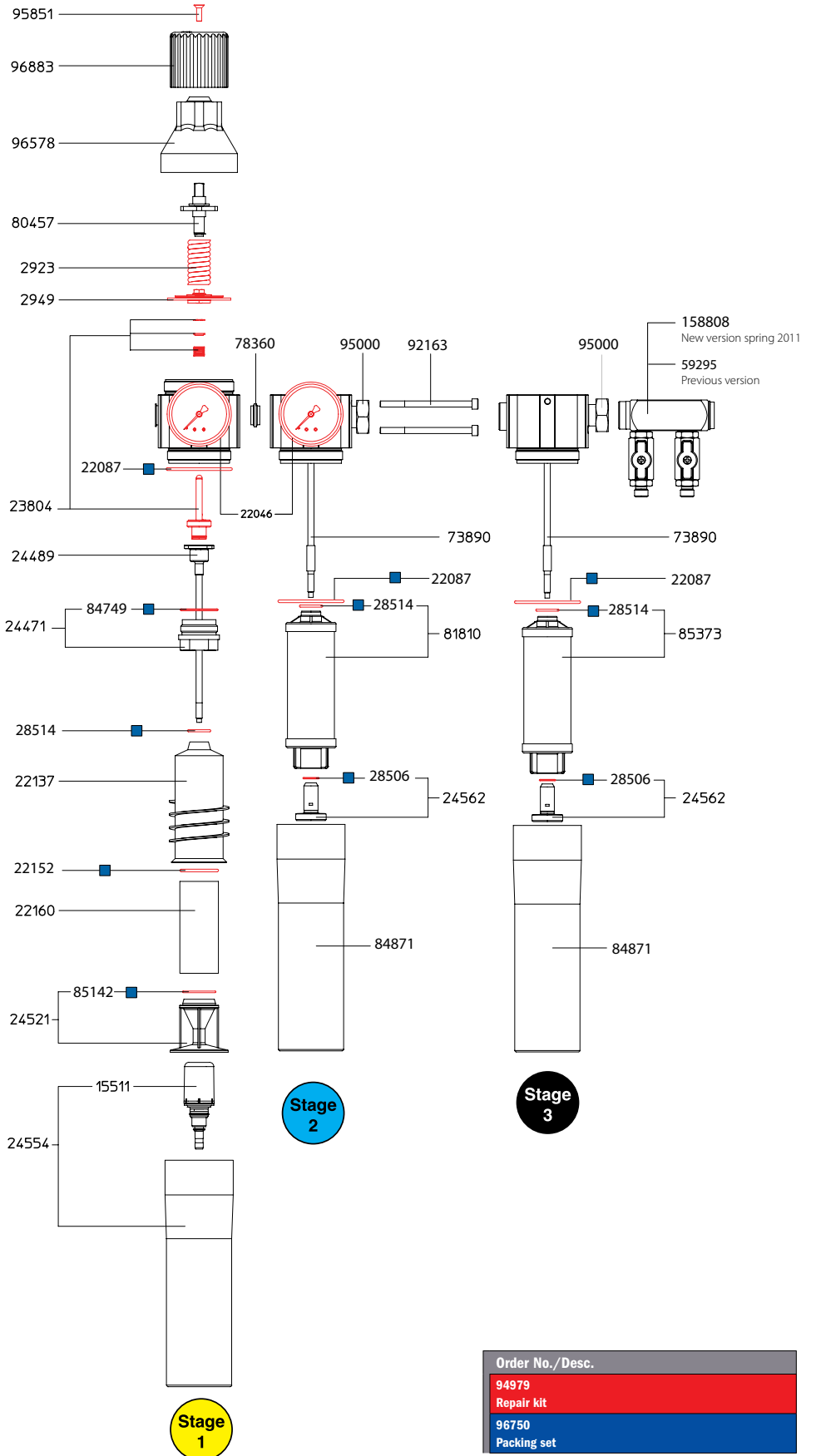

Order No./Desc.
94979
Repair kit
96750
Packing set







Technical modifications and printing errors reserved

SATA® filter 222™/242™/ 244™/ 284™

Along with the 400, the 200 filter series is the most versatile modular filter system currently on the market but at an unbeatable price. The 200 is rated at 72 cfm @ 90 psi, more than adequate for many small shops. It can be connected to compressed air pipes from either the right or left side. When atomized air leaves the spray gun, it must be clean, dry and free of condensation, silicone, oil or any other contamination. Otherwise, the finished result can have a dull finish, fish eyes, water or dust. Clean, pure air is also a must for breathing air.



SATA filter 200 series

Technical Data		
	Air inlet: G1/2 i, female thread	
	Air outlet: G1/2 i, female thread	
	Max. operating pressure: 10 bar / 145 psi	
	Max. ambient temperature: 248 °F	
	Air flow rate: 72 cfm @ 90 psi	
43687	SATA filter 222 Single Stage Single-stage sinter filter with pressure gauge, automatic condensate discharger, (G 1/2 female thread) 5 micron filter Use as an unregulated line filter	
44434	SATA filter 234 Single Stage (in-line) 0.01 micron filter unit. Provides 99.998% clean air. Compressed air must be pre-filtered when using this unit. 1/2 inch internal inlet/outlet thread.	
141226	SATA filter 264 Single Stage Activated charcoal unit removes oil vapor and organic odors. Pre-filtering compressed air is required.	
43752	SATA filter 242 Double Stage Double-stage sinter filter/fine filter with pressure regulator for air installation (G 1/2 female thread) Use as an unregulated line filter for very fine particle separation Filters down to 0.01 micron	
44404 44404-4	SATA filter 244 Double Stage Double-stage sinter filter/fine filter with pressure regulator and outlet module Use to connect regulated air to air tools and breathing air with 2 drop manifold with 4 drop manifold	
189290	SATA 282 Triple Stage (in-line) An economical three-stage filter unit. Stages include a 5 micron filter with automatic condensation discharger, a 0.01 micron fine filter and an activated charcoal filter for breathing air or spraying water borne. Used with the SATA supplied air respirator industrial belt valve or ensuring removal of oil residue when spraying water borne paint.	
141218 141218-4	SATA 284 Triple Stage (in-line) Triple-stage sinter filter/fine filter/activated charcoal with pressure regulator and outlet module Used in conjunction with the SATA supplied air respirator industrial belt valve or ensuring removal of oil residue for spraying water borne paint With 2 drop manifold With 4 drop manifold	

Technical modifications and printing errors reserved

Spare Parts SATA® filter 222™/242™/ 244™

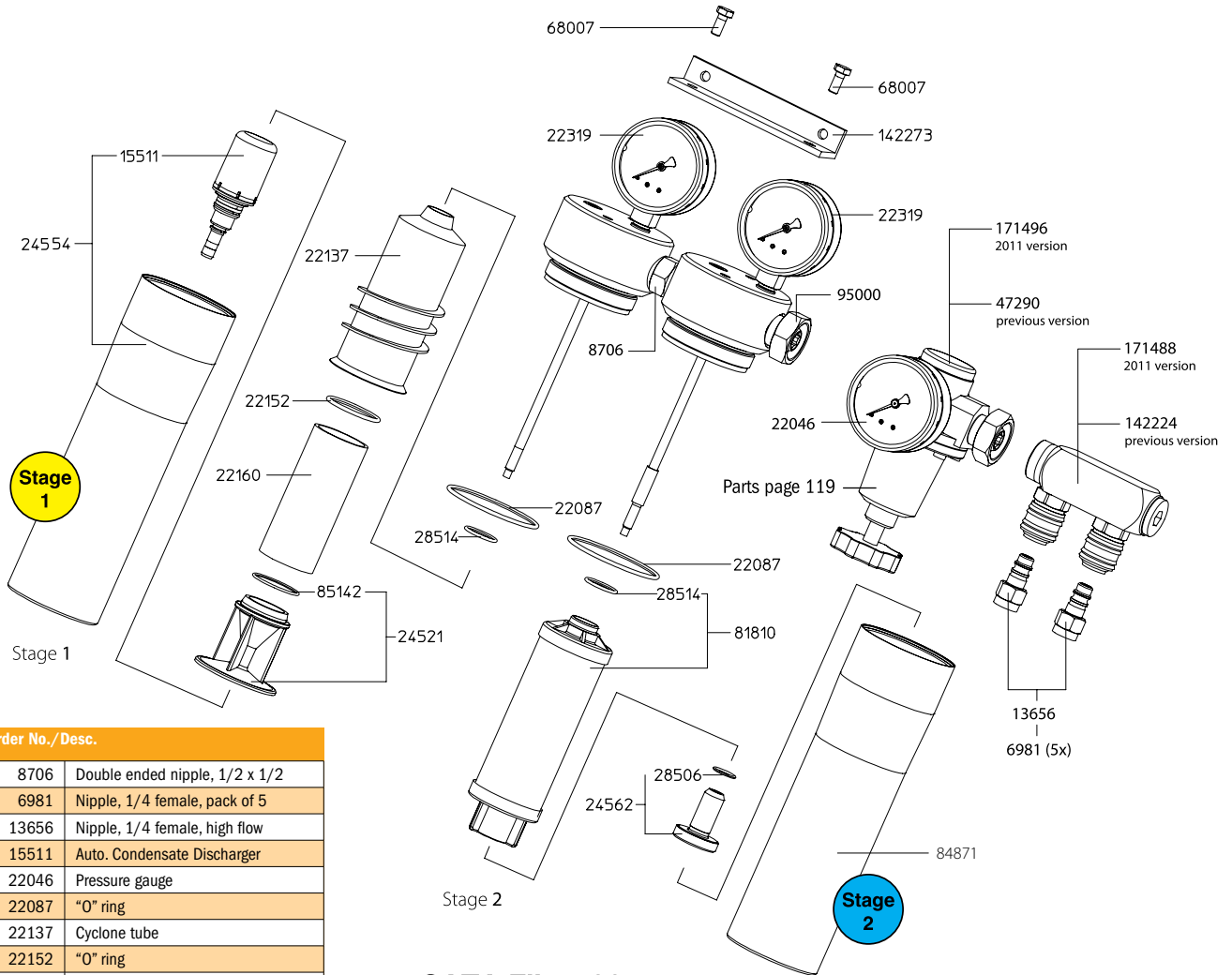



Order No./Desc.	
8706	Double ended nipple, 1/2 x 1/2
6981	Nipple, 1/4 female, pack of 5
13656	Nipple, 1/4 female, high flow
15511	Auto. Condensate Discharger
22046	Pressure gauge
22087	"O" ring
22137	Cyclone tube
22152	"O" ring
22160	Sintered bronze filter
22319	Pressure gauge, 134, 334
24521	Baffle with "O" ring
24554	Housing tube with auto. cond. dis.
24562	Adapter with "O" ring, 300
28506	"O" ring,
28514	"O" ring, 300 line
37622	Fixing angle, single filter
47290	Pressure regulator with gauge previous to 2011
68007	Hex screw, M6x14
81810	Fine filter, 134, 334
84806	Aluminum plug washer
84871	Housing tube, 2nd and 3rd stage
85142	"O" ring 30 x 1.5 300
85357	Housing spanner wrench (not illus.)
85373	Activated charcoal filter w/O-ring
95000	Union fitting
142224	Outlet manifold w/QC couplings and nipples, previous version
142273	Fixing angle, double filter
171488	Outlet manifold w/QC couplings and nipples, 2011 ver.
171496	Pressure reg. with gauge, 2011 ver

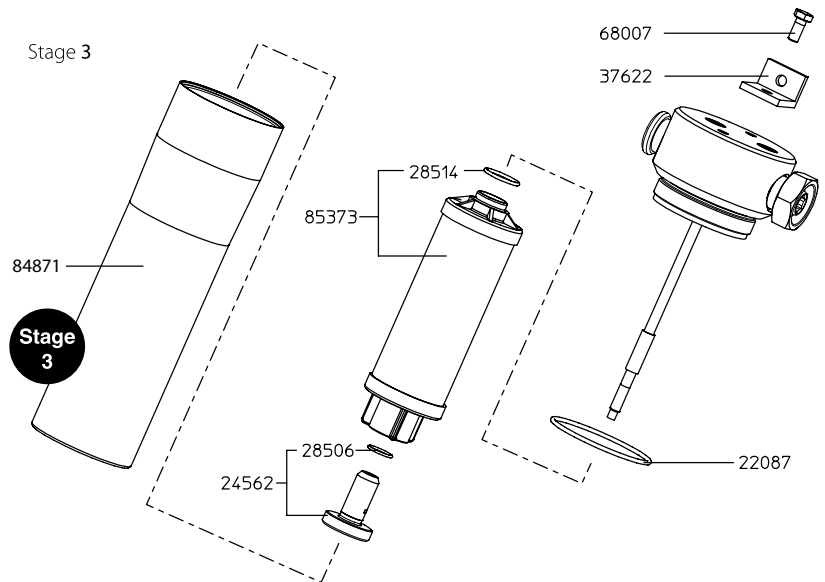







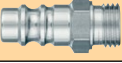

SATA Filter 264











Technical modifications and printing errors reserved



Accessories for SATA® filter series

SATA Filter cartridges		
22160	Sinter filter for SATA filter series 200, 300, 400	 stage 1
81810	Fine filter cartridge for SATA filter series 200, 300, 400	 stage 2
85365	Ultra fine filter	
85373	Activated charcoal cartridge for SATA filter series 200, 300, 400	 stage 3
214270	Service kit for filter cartridges: Includes (2) 81810 + (4) 85373	

SATA Filter accessories		
13656	SATA HVLP female nipple G 1/4 female thread (use 6981 for 5-pk)	
53942	SATA HVLP male nipple G 1/4 male thread	
13599	SATA HVLP female coupler G 1/4 female thread	
13623	SATA HVLP male coupler G 1/4 male thread	
59295	400 Series Manifold, Pre 2011 Version	
59295-4	Manifold, 2 drop	
158808	400 Series Manifold, After 2011 Version	
158808-4	Manifold, 2 drop	
158824	Manifold for 494 filter middle module only	
171488	Manifold, 2 drop, 200 series	
171488-4	Manifold, 4 drop, 200 series w/coupler and nipple	
171496	Pressure regulator, 200 series 1/2" connection Max. inlet pressure 140 ps After 2011 version	
47290	SATA Pressure Regulator 1/2" connection Max. inlet pressure 140 ps Pre 2011 version	
142224	200 Series manifold with couplings nipples, 1/2" connection	
142224-4	Manifold, 2 drop	
142224-4	Manifold, 4 drop	

SATA Filter accessories		
10934	Teflon ball tap G 1/2 inch male thread for air inlet and outlet, for SATA filters	
9878	Not a cheap throw-away. Dust, oil and condensation are filtered directly at the spray gun. 10 micron performance through sintered bronze. Condensate discharge valve. Weighs 4.4 oz.	
86892	SATA's Auto discharger is a fully automatic drain valve to eliminate condensation from your down pipes and airline drops. It is 1/2" NPT to easily connect to your drops. This requires no electricity, so can be place inside explosion proof areas.	
195222	SATA adam 2U dock only convert analog gauge to digital G1/8" Digital display sold separate, pg 80	
215053	SATA filter cover (4 pieces) fits 400 filter series A cover for both double-stage and triple-stage, protects filters from over spray, damages, dust	

Dan-Am Point of use Regulator		
675636	Dan-Am Airbrush Regulator Precise control of air flow and pressure with a 60 psi gauge, w/ bracket. 1/4"	
675635	Dan-Am In-Line Regulator Precise control of air flow and pressure with a 106 psi gauge. 1/2"	
675634	Dan-Am In-Line Regulator w/bracket Precise control of air flow and pressure with a 106 psi gauge. 1/2"	
675652	Dan-Am point of use regulator with 2 or 4 drop manifold, mounting bracket, 1/2"	
675654	Max inlet pressure: 216 psi Max. cfm: 140	

SATA Air quality control		
156299	SATA air tester, compressed air quick tester for contaminates	
7096	SATA Air Check Set-Compressed air testing device. Simply connect and allow air flow for 15 minutes or longer. Test paper traps dirt, oil and in-line contamination. Complete with test paper, tweezers, magnifying glass and exam light all in a compact carrying case.	
7666-10	Test paper, pack of 10	
7666-50	Test paper, pack of 50	
7666-100	Test paper, pack of 100	

SATA® filter timer

New SATA® filter timer

Safety at the push of a button



In order to maintain the efficiency of the filter, the unit must be regularly maintained, thus avoiding coating flaws and other quality issues and eventually expensive rework.

In order to maintain the efficiency of the filter, the unit must be regularly maintained, thus avoiding coating flaws and other quality issues and eventually expensive rework.

To remind users to exchange saturated filter elements regularly, from now on all SATA filter regulator units will be supplied with a set of SATA filter timers.

Using the SATA filter timer is extremely easy: When a new filter regulator unit is installed, each filter timer must be activated by pressing the button to "start" the servicing interval of the respective filter stage. Over time, the display window will gradually turn to red, indicating the passing of time and serving as a guide to the measure of filter saturation. Whenever a window has completely changed to red, the concerned filter cartridge needs to be replaced. In line with the two different recommended replacement intervals of approx. three (activated charcoal) or six months (fine and sintered filter) respectively, there will be two filter timer versions available.

Additionally, the replacement filter cartridges will be also supplied with SATA filter timers which have to be inserted in the self-adhesive cages on the filter canisters and activated once maintenance is completed.

Frequent malfunctions occurring without the use of compressed air filters or with insufficiently maintained filters:



- 206151 SATA filter timer only [for SATA sinter and fine filter, 6 mo.]
- 206284 SATA filter timer starter set [for SATA sinter filter, 6 mo.]
- 206292 SATA filter timer starter set [for SATA fine filter, 6 mo.]
- 206318 SATA filter timer starter set [for activated charcoal, 3 mo.]
- 206359 SATA filter timer starter set [for SATA filter 484], set of 3



1. Release of the SATA filter timer



2. The display window will gradually turn to red, indicating the passing of time



3. Once the display window has completely changed to red, the filter needs to be replaced.

Spare Parts

Pressure Regulator #47290

Order No./Desc.

2980	Diaphragm
13490	End screw cover
13912	Compression spring
14019	Valve Pin
14035	O Ring
14043	Valve seat
14068	Head piece
14076	O Ring (End Cap)
14522	O Ring 25 x 15
14530	Compression spring
16816	Bell housing
17251	Cylinder screw
17541	Counter nut M10 x 1
17590	Spindle
18077	Adjusting knob
18358	Nut, Adjusting knob
90951*	Diaphragm Repair Kit

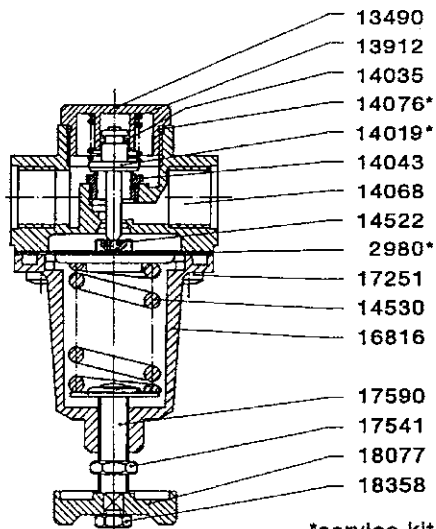

*service kit

Part No./Description

*90951
Diaphragm Repair Kit

Technical modifications and printing errors reserved

Filter Head Connection

Due to a design change on the SATA filter 400 series, the number of parts required for the connection between the 2nd and 3rd filter stage as well as between the 3rd filter stage and the outlet module has been reduced from three to only two parts.

The design of the filter head has been changed as well in order to slightly reduce the total weight of the filter unit (see illustration on the right under NEW).

SATA filter 400 series,
OLD filter head, Previous
3 piece connection



Top view filter
OLD head profile

SATA filter 400 series,
NEW filter head, Spring 2011
2 piece connection

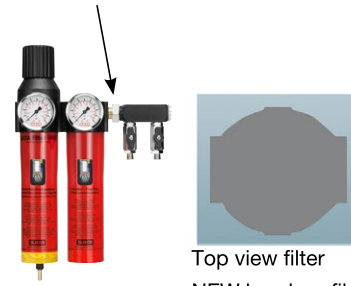

Top view filter
NEW head profile

Outlet module for SATA filter 200 & 400, released 2011

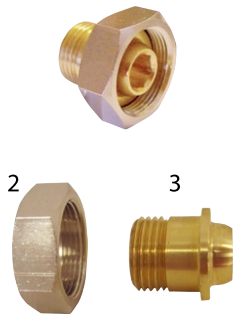

NEW Spring 2011

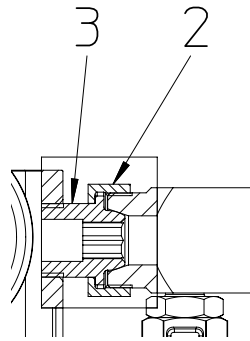

2 piece connection
Part # 95000

- 2. Union nut
- 3 Insert

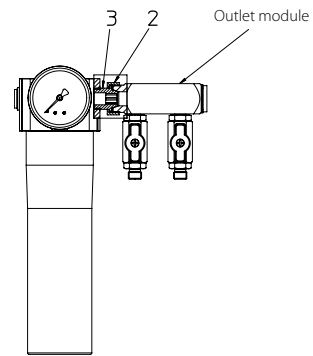

Outlet module

For the assembly of the new and old outlet module for the SATA filter 400 series, use Part No. 9500, new design modules already feature a male thread. The insert part is now installed on the opposite side, i.e. inside the activated charcoal filter unit, while the swivel-screw fitting (position 1 shown below), is no longer necessary.

Similar changes have been made to the SATA filter 200 series as well. Please refer to the respective parts breakdown for the correct module.

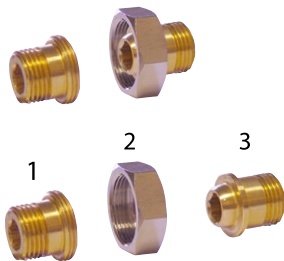

OLD

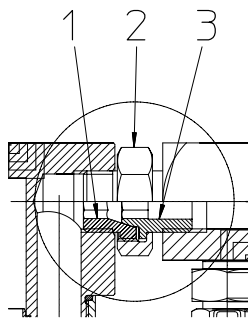

3 piece connection
Part # 95000

- 1. Swivel-screw fitting
- 2. Union nut
- 3 Insert

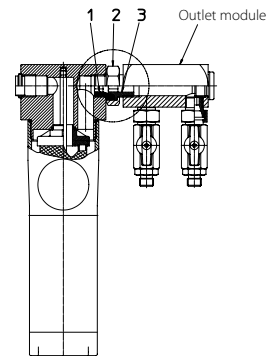

Outlet module

SATA 400 Series Filter Cutaway

Precise regulation of operating pressure

Air flow
130 cfm @ 90 psi

Reusable filter elements require little service

Cyclone separator

Sintered bronze filter
Part No. 22160

Stage 1

Stage 2

Stage 3

Low maintenance with high operating safety due to automatic condensation discharge

Corrosion-proof metal housing

Easily replaced fine filter cartridge
Part No. 81810

Activated charcoal filter cartridge
Part No. 85373

Differential pressure reading of fine filter saturation

Technical modifications and printing errors reserved

S.A.M.S.

(Supplied Air Monitoring System)

Dan-Am Company has made it easy and simple to comply with OSHA and NIOSH rules for breathing air quality and monitoring for Carbon Monoxide. S.A.M.S. is an acronym for Supplied Air Monitoring System. It is a complete breathing air system consisting of five parts: a SATA air filter, the SATA vision 2000 supplied air respirator, choice of Carbon Monoxide monitor, Premoflex breathing air hose, and all necessary couplings and fittings. One or two person systems are available. The S.A.M.S. system conforms to government regulations, delivers clean grade D air, monitors Carbon Monoxide levels, has a NIOSH approved Respirator, and has compressed air that is free of particles, oil and condensation.

Build your custom *S*A*M*S System from these components

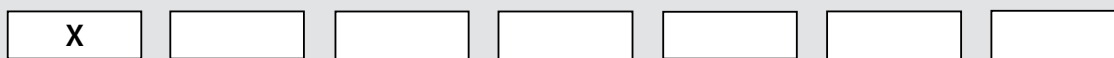

Filter Unit

- 2 244 Filter Unit (P/N 44404)
- 3 284 Filter Unit (P/N 141218)
- 4 444 Filter Unit (P/N 92296)
- 5 484 Filter Unit (P/N 92320)

CO Monitor

- 44 X144 ICOM (P/N X144)
- 67 X767 Guardian (P/N X767-PLUS)

Hose Length

- 35 35' Hose (P/N 3366-35)
- 50 50' Hose (P/N 6633-50)

1 or 2 Person

- 1 1 Person Setup
- 2 2 Person Setup (2 person receives only one X767 PLUS and only one filter unit)

All systems include whip hose (P/N 55640), Coupler (P/N 13599) & Nipples (P/N 13656) where required, Vision 2000 Full Hood and Activated Charcoal Belt Unit (P/N 36384)

EXAMPLE for part no. X 467352

This example includes:

This part number includes:

- (4) 1 - 0/444 Filter unit
- (67) 1 - X767 CO Monitor
- (35) 2 - 35' Hoses
- (2) 2 - Vision 2000 Full Hood with Charcoal belt units
- 2 - Whip hoses with Couplers and Nipples



Other system combinations are available on inquiry. Using the 3 stage charcoal filter units and longer hose lengths are other possibilities. If your ideal system is not listed above, please call 800-533-8016 for assistance.

Accessories



SATA® clean RCS™

- Safe and rapid color change with disposable cup use, even with critical changes (e.g. black / white)
- Mounts in the spray booth or in the preparation room
- Suitable for waterborne and solvent-based paint systems
- High cleaning power and residue-free removal of all paint remainders in the paint channel, even in places hard to access
- Collecting container for used cleaning liquid avoids additional soiling of the spray booth - lasting profitability and savings potentials due to increased booth filter life time
- No readjustment of the gun inlet pressure and no disconnecting required - automatic pressure adaptation when switching between "Spraying" and "Cleaning"
- Shelf space for prepared disposable cups during paint jobs
- Increases paint job frequency and capacity utilization of the spray booth

Only 2 cleaning steps:

1. Flushing and cleaning the paint channel and air cap (approx. 21 sec.)



2. Dry-blowing; used cleaning liquid is collected (approx. 4 sec.)

Technical Data

	SATA RCS turbo	SATA RCS compact	SATA RCS micro
Air consumption cleaning process		5 cfm (approx.)	
Air consumption drying process		4.5 cfm (approx.)	
Cleaning agent consumption per cleaning process		5 oz (approx.)	
Cleaning time per color change		21 sec (approx.)	
Drying time per color change		4 sec (approx.)	

SATA clean RCS

146944	SATA clean RCS - the turbo cleaner - Recommended for mounting in the spray booth - saves valuable time Optional: Conversion kit to connect large cleaning agent containers
Technical Data	Operating pressure: max. approx. 87 - 116 psi
	Dimensions: 12" w x 28" h x 9" d
	Net weight: 22 lbs



SATA clean RCS compact

192518	SATA clean RCS compact Recommended for wall mounting inside the mixing room, no need for spray air supply Supplied with one SATA RPS 0.9L disposable cup without sieve Optional: Conversion kit to connect large cleaning agent containers
Technical Data	Operating pressure: max. approx. 60 psi
	Dimensions: 12" w x 18.3" h x 9" d
	Net weight: 15.5 lbs















SATA clean RCS micro

202564	SATA clean RCS micro Recommended for wall mounting inside the mixing room, no need for spray air supply Supplied with one SATA RPS 0.9L disposable cup without sieve Optional: Conversion kit to connect large cleaning agent containers
Technical Data	Operating pressure: max. approx. 60 psi
	Dimensions: 7.3" w x 18.3" h x 8" d
	Net weight: 9 lbs



Errors, technical modifications and printing errors reserved.

Spare Parts and Accessories SATA clean RCS

Recommended connection set and Accessories		
10934	Teflon ball tap G 1/2 inch male thread for air in- and outlet	
146514	Air hose 13 mm, 500 mm long, with connection for SATA cleanRCS	
13581	SATA quick coupling 101.38 g 3/8 female thread	
640122	Grounding cable, 10 ft, 4 mm, assembled	
9886	SATA gravity gun holder for gravity cup spray guns	
146985	Repair kit SATA clean RCS	
146993	Splash guards and fixing rivets, pack of 5 each	
147017	Replacement brush, pack of 2	
147025	Replacement tubes, pack of 2	
153965	Replacement tubes, for use when using cup adapters for increased material passages. 95mm, pack of 2	
192633	Flexible tube, aluminum, 16', for suction of solvent vapors	
189472	Conversion kit external cleaning agent - suction and recirculation for SATA clean Conversion kit consists of 2x material hoses, installation guide	 <p>containers not included</p>

SATA clean RCS Turbo Air Flow parts

Pos.	Part No.	Description
1	158709	Complete top assembly, SATA RCS
2	*	Inlet fitting
3	146308	3 way selector valve w/knob
4	146720	Knob only, for #146308 valve
5	147140	Air valve for drying w/o knob, RCS
6	147108	Button knob only for #147140 valve
7	*	Regulator
8	*	Outlet fitting
9	145755	Black connection box (not shown)

* Inquire, call 1-800-533-8016
Any other parts please inquire

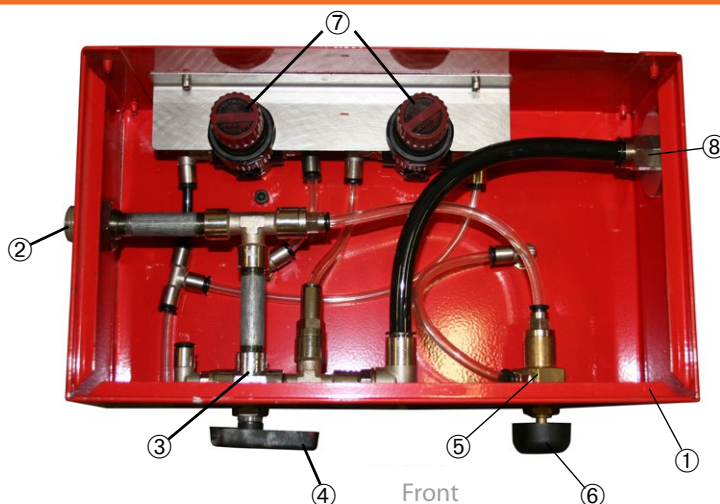

Errors, technical modifications and printing errors reserved.

SATA® dry jet 2™

SATA dry jet 2

Technical Data

Air consumption: 9.5 cfm
Recommended operating pressure: 29-35 psi
Max inlet pressure: 145 psi



Available version

217489	<p>SATA dry jet 2</p> <p>This practical, lightweight blow gun makes quick work of drying waterborne material. A special nozzle design multiplies air volume from ambient air using the Venturi injection principle. An air intake filter prevents contamination of the paint. Air consumption is only 9.5 cfm at 35 psi. The CFM is magnified x10 to give a 92.35 CFM output.</p> <p>SATA dry jet 2 blow gun w/valve.</p>
--------	---



SATA dry jet 2 parts

223834	SATA flat fan nozzle
222232	SATA dry-jet filter holder
222125	SATA spare flat sieve 125 µm, pastel blue (10 pieces)
13656	Quick connect female nipple, 1
6981	Quick connect female nipple, 5 pk

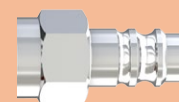

SATA dry jet 2 stand (adjustable height: 30 - 190 cm)

82198	Dry Jet stand only, complete without blow guns
223008	SATA Dry Jet 2 stand with height adjustable bracket and 2 blow guns (217489)
223503	SATA Dry Jet 2 Jumbo stand with height adjustable bracket w/4 SATA Dry Jet 2 blow guns
84145	Height extension, approx. 1.2 m (47.2") for SATA dry jet stand
86140	Width extension for SATA dry jet stand with one blow gun (217489)

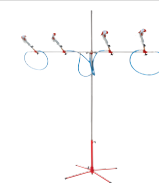
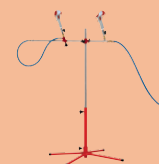

SATA® dry jet™

SATA dry jet

Technical Data	Air consumption: 10 cfm
	Recommended operating pressure: 29-36 psi
	Max inlet pressure: 174 psi



Available version

82222	SATA dry jet This practical, lightweight blow gun makes quick work of drying waterborne material. A special nozzle design multiplies air volume from ambient air using the Venturi injection principle. An air intake filter prevents contamination of the paint. The SATA dry jet blow gun is now available with or without the handle and shut-off valve. Air consumption is only 8.2 cfm at 29 psi. SATA dry jet blow gun w/ handle and valve.	
144105	The SATA dry-jet "S" is specifically designed for mounting on one of our blow gun stands. The dry-jet "S" makes drying waterborne very quick and convenient.	

SATA dry jet parts

81869	SATA dry-jet filter holder	
81836	SATA dry-jet ball valve	
82248	SATA dry-jet filter, pack of 3	

SATA dry jet stand (adjustable height: 30 - 190 cm)

82198	Dry-Jet stand only, complete without blow guns	
82230	SATA dry jet stand with height adjustable fixing and 2 blow guns (82222)	
161489	Jumbo stand w/4 SATA dry-jet blow guns	
84145	Height extension, approx. 1.2 m (47.2") for SATA dry jet stand	
86140	Width extension for SATA dry jet stand with one blow gun (82222)	

Errors, technical modifications and printing errors reserved.

Spare Parts SATA® dry jet™ Stand

Order No./Desc.
80200 Connection, dry-jet S
81380 Hose only, Sata dry-jet adjustment mount
82198 Stand w/o blow guns
83832 Cross bar connection
83840 Stand complete (can be disassembled)
84145 Vertical extension approx 1.2 m stainless steel
86165 Adjustable air connection, SATA dry-jet
86140 Horizontal extension w/third blow gun
123786 Cross connection, (complete), dry jet

Art. No. 82230
Illustration without SATA
dry jet blow guns

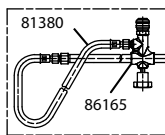
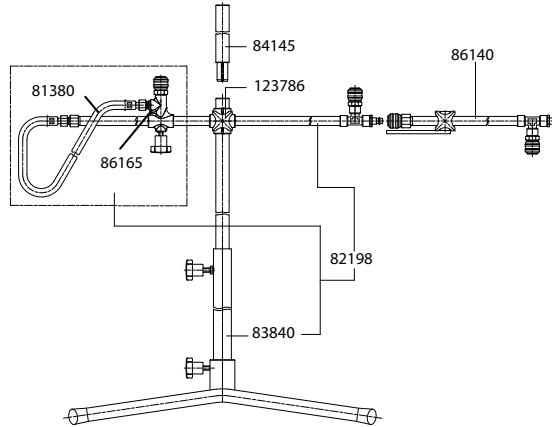

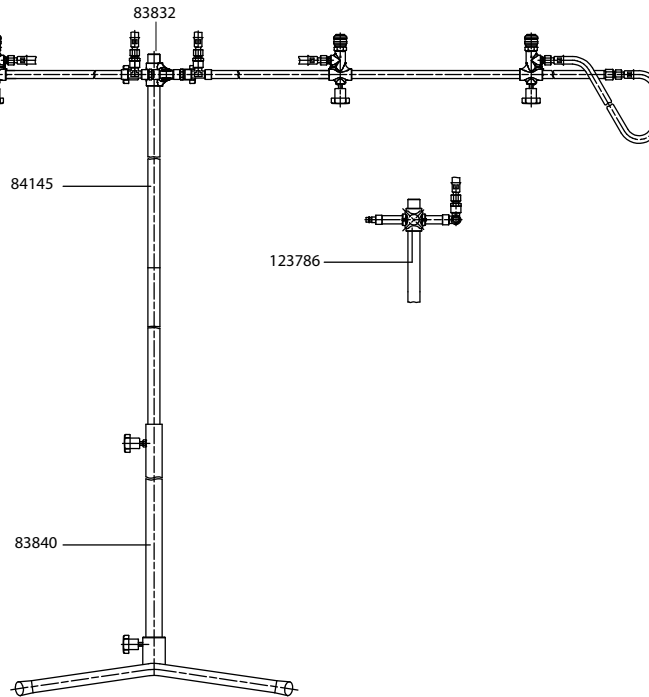

Art. No. 161489
Illustration without SATA
dry jet blow guns



Errors, technical modifications and printing errors reserved.

Dan-Am blow gun stands and parts







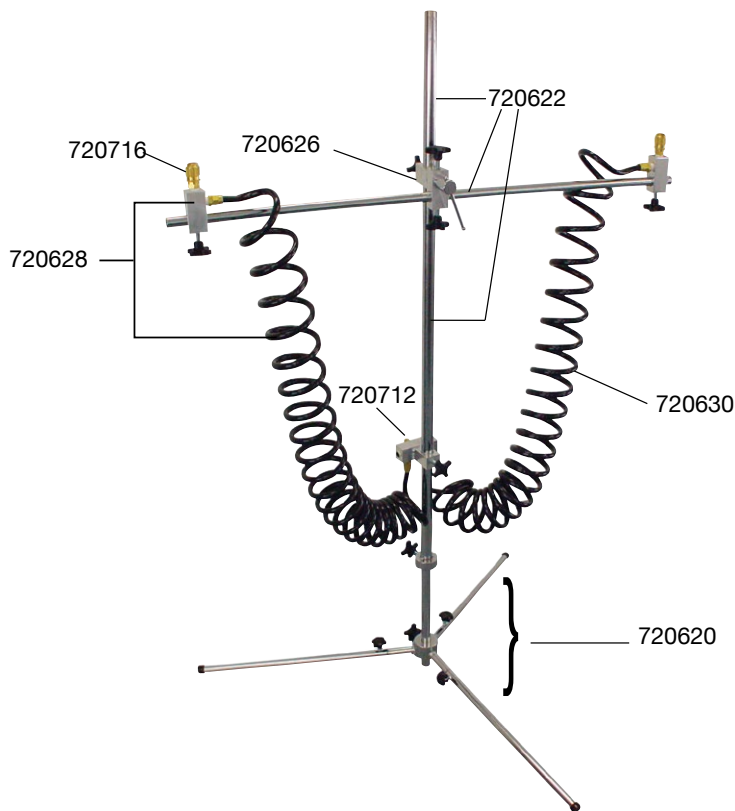



Econo-jet Blow Gun Stand		
<p>This economical mobile stand holds up to two SATA blow guns, adjustable gun height, with 360° swivel or tilt. Supplied with high flow connections and tubing for maximum performance of the blow gun. It is easily set up and compact for storage. It is fully compatible with SATA's dry-jet or dry-jet 2 blow gun. The stand will be offered as a package with two guns.</p> <p>This is a must have tool for drying waterborne paint, as waterborne dries substantially faster with air flow, saving time for more added production.</p>		
720580	Econo-Jet stand only	
720640	Econo-Jet stand w/ 2 SATA dry-jet 2 blow guns (217489)	
720610	Econo-Jet stand w/ 2 SATAdry-jet "S" blow guns (144105)	
720600	Econo-Jet stand w/ 2 SATAdry-jet blow guns (82222)	

Dan-Am Econo-Jet Stand

Order No./Desc.	
720620	Base Assembly
720622	3 pc. Pipe Set
720624	Knob, set of 4
720626	Swivel Cross Assembly
720628	Air Delivery Component Set
720630	Coil Air Hose
720712	Hi Flow Nipple
720716	Hi Flow Coupler



Grit Blasting Equipment / Blow Guns

Grit blasting equipment		
17335	SATA grit blasting gun super version spraying pipe w/ carbide insert	
39172	SATA sandblasting set: sand blast gun with carbide pipe, mask, gloves, blast material special order item only	
17699	SATA sandblasting hood	
<p>SATA blow guns reduce costs by saving compressed air. Three types of nozzles are available in standard, noiseless and multi nozzle. The high efficiency multi nozzle design triples the air volume by means of a <i>following-up effect</i>. The noiseless type lowers the noise level to 79 db at 60 psi. Straight and curved nozzle extensions are available for special requirements. Air consumption of about 5 cfm at 45 psi. SATA Multi and Noiseless nozzle versions prevent pressure build-up if tip is blocked or "dead ended" Complies with OSHA requirements 1910.242b and 1910.95 when used on an air line of 150 psi or less. The standard version does not have safety by-pass and must use regulated pressure not exceeding 30 psi.</p>		
15156	SATA blow gun with standard nozzle	
26070	Standard nozzle for SATA blow gun 15156 (blow gun)	
15180	SATA blow gun with low noise metal nozzle	
77586	Special low noise nozzle for SATA blow gun 15180 (blow gun)	
15214	SATA blow gun with multi nozzle	
26047	Metal multi-nozzle M14 x 1	
133306	SATA turbo blow with quick coupling nipple	
59675	Dosenboy, heavy-duty accessory provides easy removal of paint and solvent container tins lids. For ease of flattening of the container Adjustable to 14" height, replaceable blade	

Errors, technical modifications and printing errors reserved.

Spare Parts SATA Grit Blasting, Blow gun, UBE undercoating, Dosen-Boy

Order No./Desc.	
12831	Hexagon nut SPO ascending pipe
17699	SATA HMO head protection hood
21154	Blast pipe w/carbide insert
21451	Lid for 0.6 l PVC suction cup
25411	Blast pipe w/ carbide insert
38141	SATA SGE gun with carbide spray pipe
64394	Screen, pack of 5
64402	Glass visor screens, pack of 5

SATA grit blasting gun

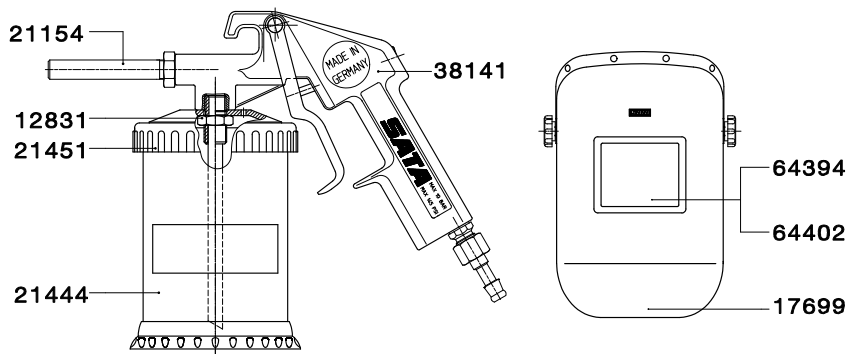

Order No./Desc.	
109	Air inlet fitting
15156	Blow gun, standard
15180	Blow gun, noiseless
15214	Blow gun, multi-nozzle
26047	Head, multi-nozzle
26070	Head, standard
55269	Gun body
77586	Head, noiseless

SATA Blow Gun

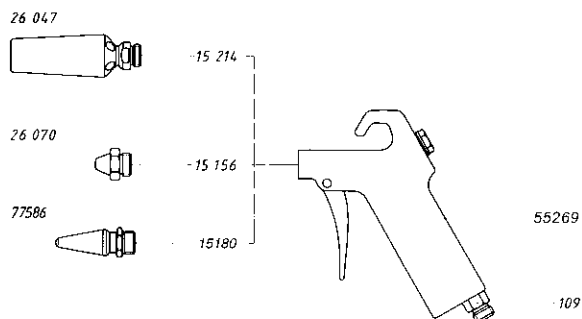

Order No./Desc.	
4788	Trigger
11098	Packing, air piston
11437	End screw
12864	Spray tube
26054	Pressure spring
53082	O ring, air piston
65979	Air piston
65987	Trigger pin
65995	Pickup tube
66001	Nozzle
66019	Circlip

SATA UBE Undercoating Gun (#12740 for one way cans-euro)

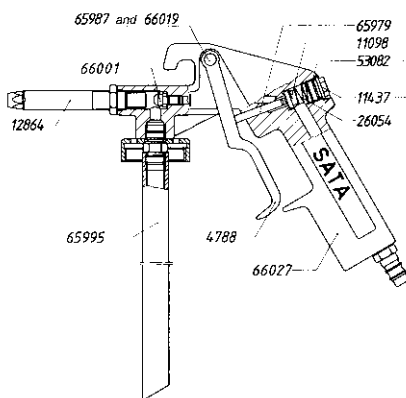

SATA Dosen-Boy (tin can opener)

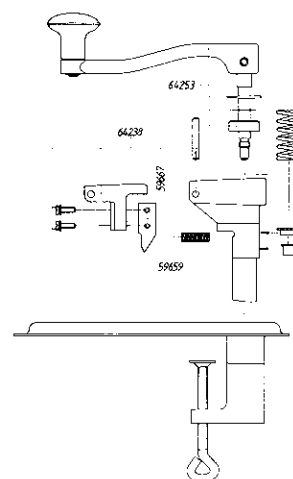

Order No./Desc.	
59659	Transport gear
59667	Blade
64238	Blade assembly
64253	Handle assembly

Errors, technical modifications and printing errors reserved.

Rustproofing Equipment

Cavity preservation, Type 1		
9795	SATA HRS pressurized cup spray gun, Type 1, with 1.0 l cup with wands, flexible nylon, door and hook wand Special equipment for hollow cavity corrosion protection. Refillable 1 liter pressurized cup to 150 psi. May be used free spraying or connected to wands. Fine atomization from mixing cap and pressurized cup. The standard model uses Type 1 connection (small wand coupling). Complete with cup, quick coupling, steel door wand #16071, flexible nylon wand #16113 and hook wand #16139	
12658	SATA HRS pressurized cup spray gun with 1.0 l cup, material flow control, without wands, Type 1	
11072	SATA HRS pressurized cup spray gun with 1.0 l cup, material coupling, without material flow control, without wands, Type 1	
16071	Fixed door wand (steel), Type I, 1.1 m long, 8 mm, with radial nozzle 360 ° radial fan	
16113	Flexible nylon wand, 1.3 m long, Type I, 8 mm, with radial nozzle 360 ° radial fan	
11866	Venturi hook wand, 4 mm, with flexible guideway hose, Venturi spraying tube, for cavity and surface application	
11874	Flexible nylon wand 1.5 m long, 6 mm, with radial nozzle 360 ° radial fan and diagonal spray	
16139	Venturi hook wand, .7mm with flexible rubber hose	
24372	Flat hook nozzle for HRS	
25486	Round spray nozzle for surface application and under body protection	
8359	Material coupling for clear passage for wand systems	
16048	Quick coupling nipple for wands 80-4133 G 1/4	
196832	Door wand, nickel-plated steel, 6" effective length, 0.8 mm, with radial nozzle 360° for radial fan and forward spraying, 39" flexible guide hose	
Cavity preservation, Type 2		
27565	SATA HRS Rust Protection, Type 2 Economy version with 1 liter pressurized cup to 150 psi., with one nylon wand (#77941) and one hooked nylon wand (#54460)	
77941	Flexible Nylon wand, 1500mm, Type 2, w #16170 coupling	
16154	Rigid nylon wand, 1100, Type 2, 1.100 mm Ø 8 mm, with radial nozzle 360 ° radial fan and diagonal	
54460	Hook wand, 750mm, Type 2	
16170	Coupling, Type 2	
16055	Hook wand nipple, Type 2	
11213	Round spray nozzle, Type 2	
Under body protection		
12740	SATA UBE suction gun for underbody protection from disposable containers Type 1, European containers (9.5" pick-up tube)	
H823W	Dan-Am undercoating gun for efficient means of rust prevention. U.S. throw away containers	

Spare Parts SATA® HRS™

Order No./Desc.	
3426	Safety washer 4 mm DIN 6799 stainless steel for trigger
8300	Suction pipe, drilled"
8318	Sealing ring
8359	Material coupling for clean passage for want systems, Type I
11437	End screw
11445	Compression spring
11460	Air piston
11494	Cam rod, complete with O-ring
11502	Paint needle 1.5, complete with needle sleeve
11510	Mixing cap, completely machined
11544	Compression spring for paint needle
12591	Bracket bolt for SATA paint spray guns except SATAminijet
15438	Paint needle packing
16071	Fixed door wand (steel) 1.300 mm Ø 8 mm, with radial nozzle 360 ° radial fan, Type 1
16113	Flexible nylon wand 1.300 mm Ø 8 mm, with radial nozzle 360 ° radial fan, Type 1
16139	Venturi hook wand, .7mm with flexible rubber hose, w/ radial nozzle 360° radial fan + spraying diagonally backwards + forwards, Type 1
16170	Wand coupling, large, Type 2
24372	Flat hook nozzle for HRS
25486	Round spray nozzle for surface application and underbody protection
41806	1.0 l aluminum pressure pot max pressure 10 bar / 150 psi complete with threaded ring
53082	O-ring 12 x 1.5 mm made of Perbunan
68890	Valve, cpl."
133983	Air connection piece G 1/4a
157305	Trigger
193060	Bushing seal for cup

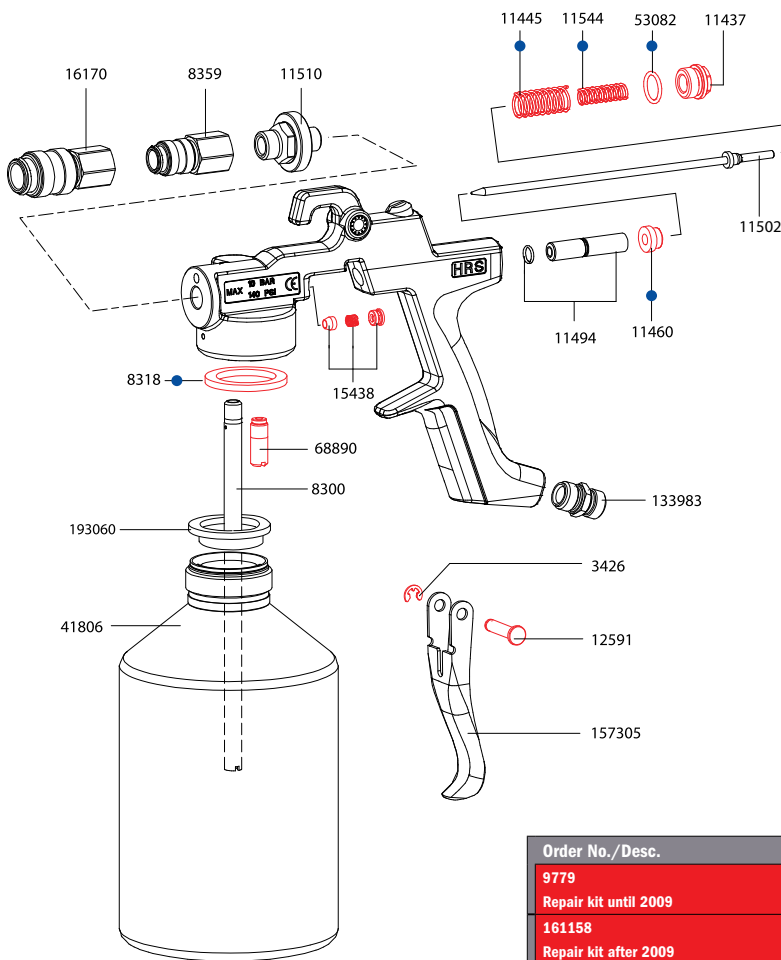

Order No./Desc.
9779
Repair kit until 2009
161158
Repair kit after 2009
50617
Air piston service set

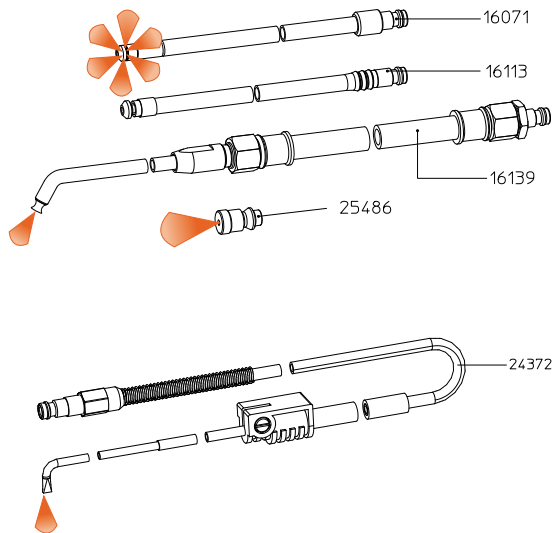

Errors, technical modifications and printing errors reserved.

Rustproofing Equipment

Barrel pump unit for cavity preservation

14555 SATA HKU pump unit 1:3 cpl., consisting of pump 3:1, with pair of hoses 10 m, jet 1000 KK spray gun, 3 wand set, type 1 connection

HKU Technical Details

Pump volume with nozzles:	app. 0.036 cfm
Air consumption spray gun:	7.1 cfm
Air consumption pump at 72.5 psi inlet pressure:	8.2 cfm
Air connection thread:	G 1/4 outs. thread
Total weight:	24.2 lb / 11 kg
Max. air pressure:	150 psi
Min. air pressure:	37.5 psi
Max. material pressure:	450 psi

HKU Technical Details

Bursting pressure:	2250 psi
Free material flow:	approx. 22 l/m
Air Connection:	G 1/4 int.
Material outlet:	G 3/4 int.
Material outlet:	suction pipe G 3/4
Noise emission at 0.MPa (105 psi):	79 dB (A)2
Barrel connection with 2" thread is supplied with the pump.	

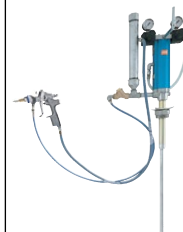

34389 SATA HKU barrel pump unit, 200 l, consisting of pump 3:1, hose pair 10 m long, jet 1000 KK spray gun, 3 wands with type 1 connection

153700 SATAjet 1000 K 1.5 paint tube G 1/4a, special connection with coupling (8359) page 26 & 27 for details



17251WS Wand set, Type 1, set of 3
 1) nylon wand #16113 - 8 x 1300mm, 1) door wand #16071- 8 x 1100mm,
 1) hook wand #11866- venturi 750mm

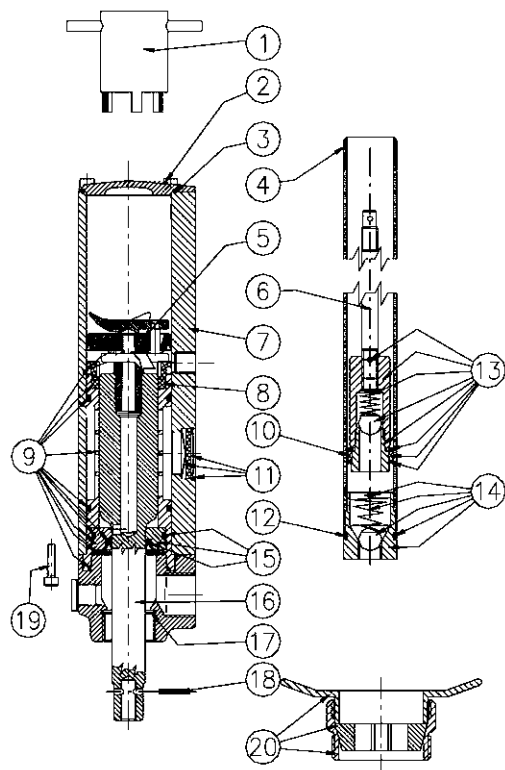

HKU pump unit

Order No./Desc.	Pos.
51961 Packing kit	8, 10, 12, 15, 17, 18
51979 Air motor repair kit	2, 3, 9, 16, 18, 19
57406 Pump tube repair kit	13, 17, 18
16063 Guiding hose	
23291 Reduction nipple	
30437 Pressure compensation containers, cpl.	
34819 SATA material-feed pump 1:3 60 l with control unit	
38679 Suction pipe for 60 ltr. Barrel	
39594 Sieve insert	
39727 Barrel-screwing	20
49494 SATA material feed pump 1:3 for 200 l, with control unit	
55517 Valve mechanism cpl.	5
57471 Bottom valve cpl.	14
57521 Piston rod	6, 18
70086 Suction tube for 200 ltr. barrel	
80622 Pump fittings	

Spare Parts SATA® HKU™ pump

See Index for Spray-Mix Material Nozzles

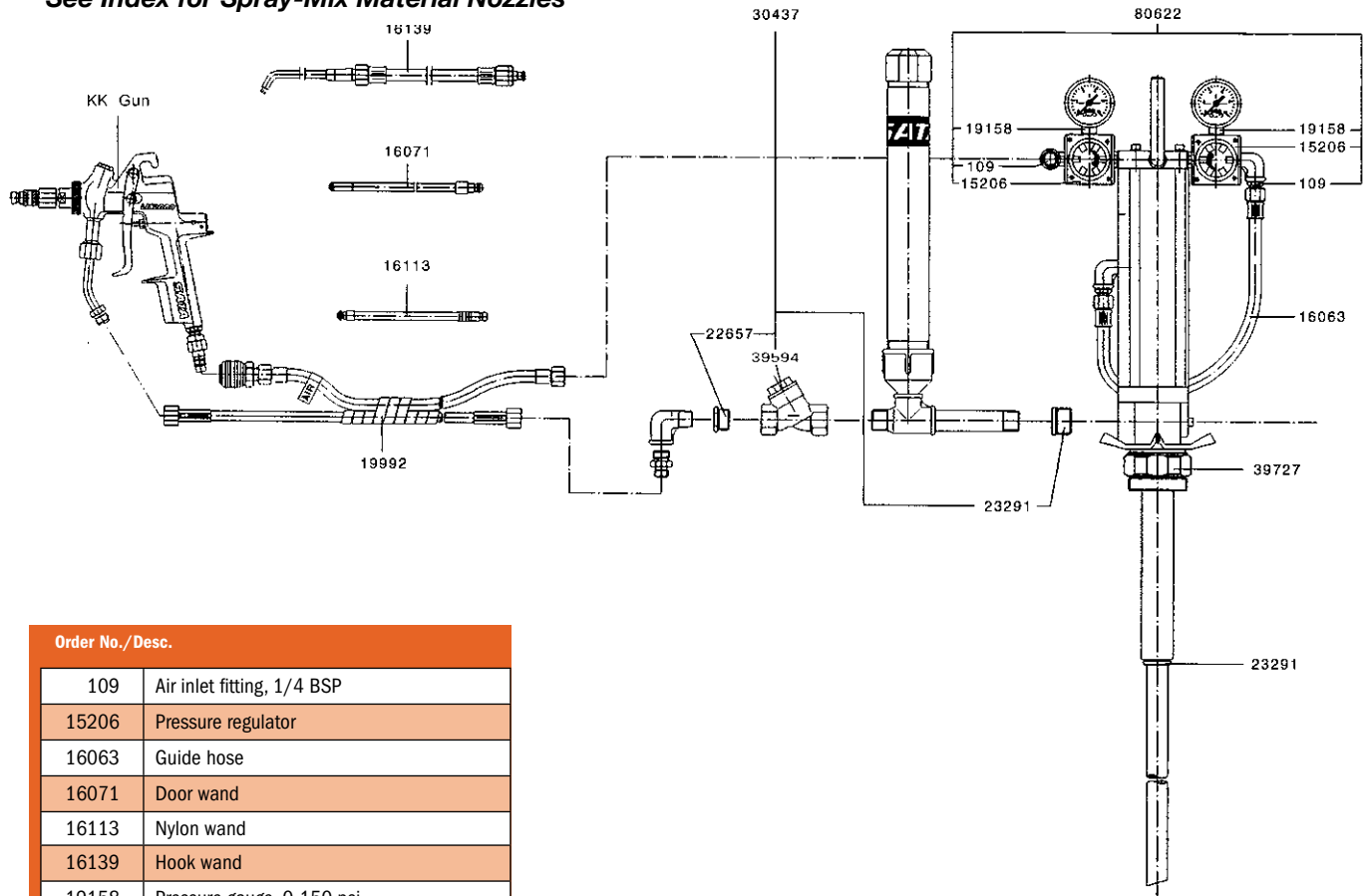

Order No./Desc.	
109	Air inlet fitting, 1/4 BSP
15206	Pressure regulator
16063	Guide hose
16071	Door wand
16113	Nylon wand
16139	Hook wand
19158	Pressure gauge, 0-150 psi
19992	10 meter combination hose, with fittings
22657	Bushing, 3/8 x 1/2
23291	Reducing nipple, 3/4 x 1/2
30437	Pressure compensation container
38679	Suction pipe, 60 liter
39594	Sieve insert
39727	Barrel screw
51961	Packing kit (#8, 10, 12, 15, 17, 18)
51979	Air motor repair kit (#2, 3, 9, 16, 18, 19)
55517	Valve mechanism, cpl. (#5) (N/A separately)
57406	Pump tube repair kit (#13, 17, 18)
57471	Bottom valve, cpl. (#14)
57521	Piston rod (#6, 18) (N/A separately)
80622	Pump regulator and fittings

Errors, technical modifications and printing errors reserved.

SATA® vario top spray™



SATA vario top spray

Technical Data	Pump ratio: 1:1
	Material Pressure: 8.0 bar / 116 psi
	Material flow volume (at 220 DH): 32 l/min
	Air inlet pressure min: 0.8 bar / 11.6 psi
	Air inlet pressure max: 8.0 bar / 116 psi
	Version and weight without add-on components Aluminum: 6 kg / 13 lb Stainless steel: 12 kg / 26 lb

SATA vario top spray - Pumps

56010	Double diaphragm pump 1:1, industrial version, material connection G 3/8" (female thread), air inlet G 1/4" (female thread), without grounding cable	
90662	Double diaphragm pump 1:1, stainless steel, industrial version, material connection G 3/8" (female thread), air inlet G 1/4" (female thread), without grounding cable	

Aluminum versions

81661	SATA vario top spray S, double diaphragm pump 1:1, with stand, material fine pressure regulator, without spray gun and hoses	
61507	SATA vario top spray W, double diaphragm pump 1:1, for wall mounting, with material fine pressure regulator, suction tube and 1 spray gun connection, without spray gun and hoses	
61515	SATA vario top spray F, on trolley, double diaphragm pump 1:1, with material fine pressure regulator, with suction tube	
138941	SATA vario top spray FFB, double diaphragm pump 1:1, on trolley, with gravity flow container, material fine pressure regulator, without suction tube, 1 spray gun connection, without spray gun and hoses	
62745	SATA vario top spray FFB, double diaphragm pump 1:1, on trolley, with gravity flow container, material fine pressure regulator, suction tube, 1 spray gun connection, without spray gun and hoses	

Stainless Steel Versions - pump and material passages made of stainless steel

81406	SATA vario top spray S, for waterborne paints, w/ stand and material fine pressure regulator, suction tube and one spray gun connection	
72678	SATA vario top spray W, for waterborne paints, wall mounted version, with suction tube, w/o gun or hoses	
72694	SATA vario top spray F, for waterborne paints, on trolley, with suction tube, w/o gun or hoses	
138958	SATA vario top spray FFB, double diaphragm pump 1:1, stainless steel version, on trolley, with gravity flow container, fine material pressure regulator, without suction tube and 1 spray gun connection, without spray gun and hoses.	
95109	SATA vario top spray FFB, double diaphragm pump 1:1, stainless steel version, on trolley, with gravity flow container, material fine pressure regulator, suction tube and 1 spray gun connection, without spray gun and hoses	

Additional pumps and pressure pots on pages 174-190

Spare Parts SATA® vario top spray™

Order No./Desc.
17483 Trolley complete
19158 Pressure gauge 1-10 bar, 50 mm G 1/4 (0-150 psi)
19851 10-pk sieves
23986 Spray gun connection (air)
24240 Single pressure reducer w/ gauge 0-10 bars / 0-150 psi
74187 Suction globe complete, for waterborne materials
81604 Wing shaped handle
82107 Double pressure reducer, complete with gauge 0-10 bar / 0-150 psi
89169 Goose neck
149716 6.0 l gravity flow cup with lid
149732 Container stud
149740 Sealing A 33 x l 23
149948 2-pk flat sieve 20 mesh

	Standard version	Stainless steel version
1	61192 Double diaphragm pump for SATA vario top spray, coated version	88641 Double diaphragm pump for SATA vario top spray, for waterborne paints, w/ material connection M 25 x 1.5 outside thread / G 1/4 outside thread
2	24422 Material fine pressure regulator, cpl., for SATA vario top spray	25338 Material fine pressure regulator cpl. for SATA vario top spray, all parts made of V2A stainless steel
3	72918 Spray gun connection (material) cpl.	57570 Spray gun connection (material) cpl. to material fine pressure regulator for second gun
4	62232 Suction hose complete for Top-Spray	45047 Suction hose cpl., for waterborne paints, for SATA vario top spray
5	73866 Ascending pipe cpl. w/ suction cap and sieve insert for SATA vario top spray	74203 Suction tube cpl., for SATA vario top spray, for waterborne paints, on trolley, w/ gravity flow container
6	79921 Suction tube cpl. w/ suction globe and sieve insert for SATA vario top spray	80879 Suction pipe cpl., for vario top spray mobile, w/o gravity recipient, for waterborne paints
7	74245 Sieve unit, mesh size 1.0, for SATA vario top spray, for waterborne paints	74237 Sieve unit, mesh size 0.5, for SATA vario top spray, for waterborne paints
8	8706 Nipple 1/2" x 1/2" BSP	82941 Double nipple G 1/2 outside thread, for sleeve ball tap, for SATA vario top spray, for waterborne materials
9	41368 Angle A 1, G 1/2 GF No. 90 galvanized version	56564 Angle 90 degree Rp 1/2 V2A, Wst.1.14436 for SATA vario top spray waterborne version
10	82909 Conversion set for gravity container SATA vario top spray	74211 Conversion kit for gravity flow container SATA vario top spray, for waterborne paints
11	37986 Add-on kit for 6 l plastic gravity container, complete with three-way ball tap and holder	37226 Add-on kit for 6 l plastic gravity container, cpl w. 3-way ball tap and holder

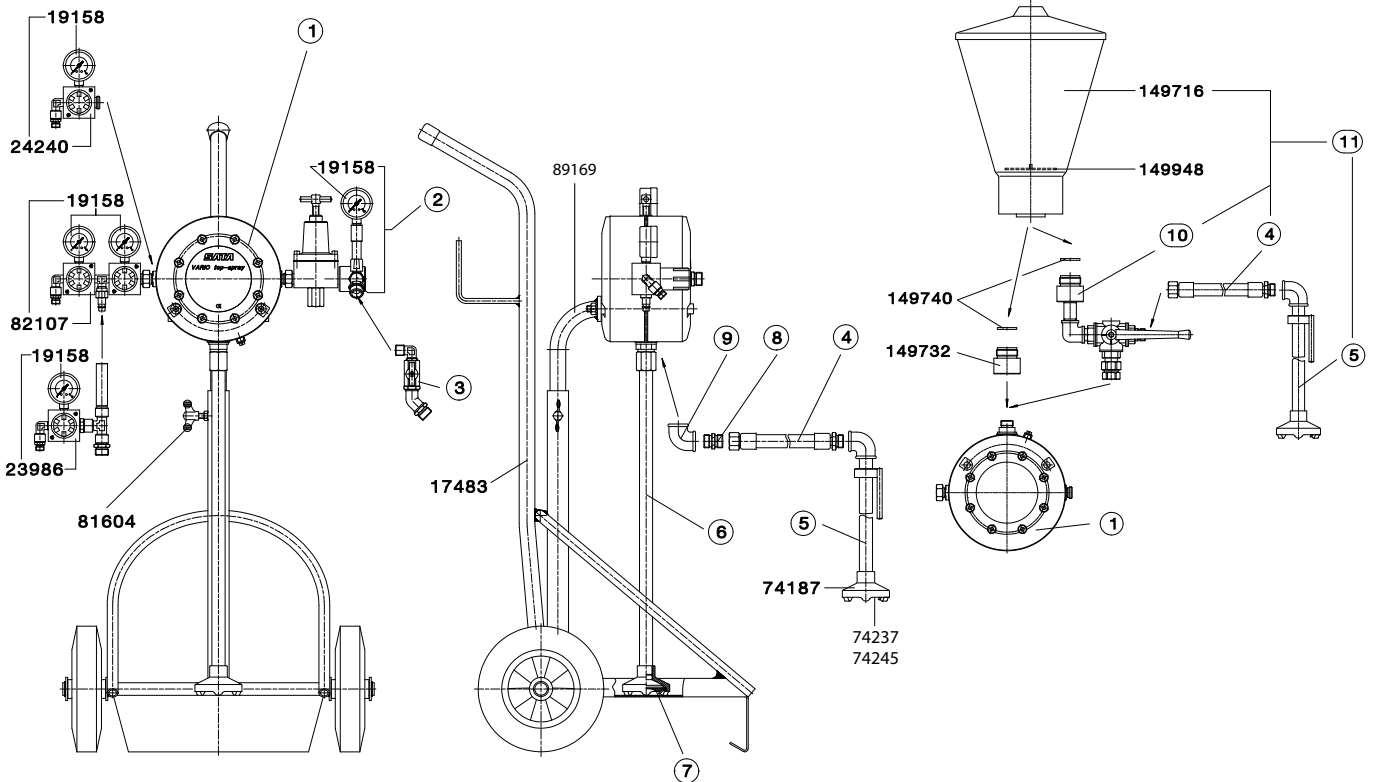

Errors, technical modifications and printing errors reserved.

Spare Parts SATA® vario top spray™ Pump

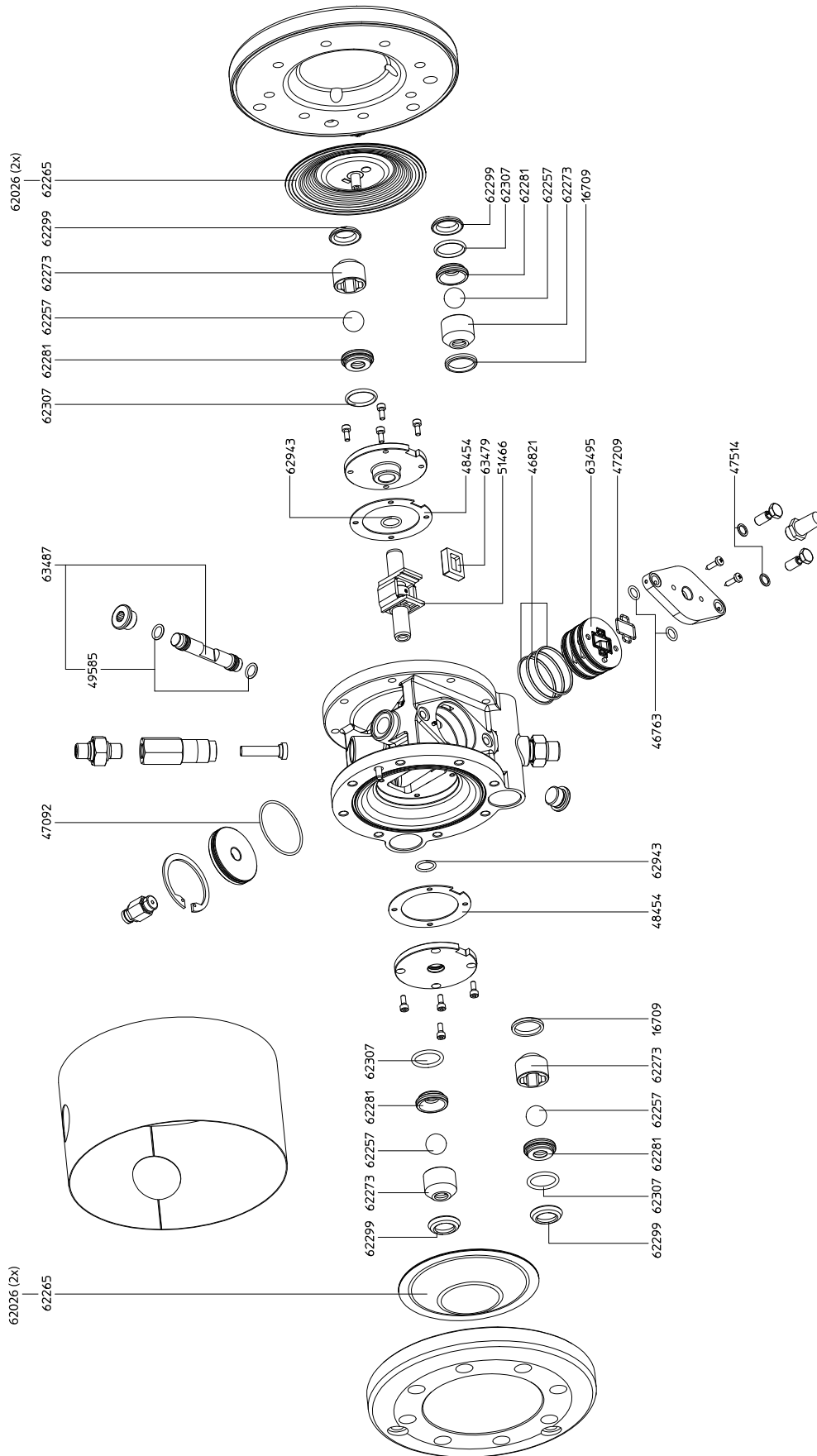

Spare Parts SATA® vario top spray™ Pump

Order No./Desc.	Kit
45195 Set of sealings, complete, for top spray double diaphragm pump	1
60012 Diaphragm repair kit for SATA vario top spray	2
60038 Control repair kit for SATA vario top spray	3
60228 Valve repair kit for SATA vario top spray	4
60301 Carrier rod repair kit for SATA vario top spray	5
60657 Carrier repair kit SATA vario top spray	6

We generally recommend using aforementioned seal and repair kits as well as exchanging all essential seals and components

Single components of the seal and repair kits

Order No./Desc.	Contained in the kit:
16709 Sealing for vario top spray industrial version	4
46763 O-ring 9 x 2 B for double diaphragm pump top spray	1 3 5
46821 O-ring 42 x 2 for double diaphragm pump top spray	1 3 5
47092 O-ring 48 x 2 for double diaphragm pump top spray	1
47209 Shape seal for double diaphragm pump top spray	1 3
47514 Sealing ring 8.2 x 11.4 x 1 for double diaphragm pump top spray	1 3 5
48454 Flat seal D 72 x T 1 for double diaphragm pump top spray	1 6
49585 O-ring 10 x 2 mm, made from Perbunan 10 shore	1
51466 Driving pin double diaphragm pump top spray	6
62257 Ball 18 mm for double diaphragm pump top spray	4
62265 Diaphragm complete D123 for SATA double diaphragm pump top spray	2
62273 Ball-bearing for double diaphragm pump top spray	4
62281 Valve seat D12 short for double diaphragm pump top spray	4
62299 Profile packing 17.2 x 28.2 x 5.4 for double diaphragm pump top spray	1 2 3 4 5 6
62307 O-ring 22 x 3 mm, FP 7010, for double diaphragm pump top spray	1 4
62943 O-ring 14 x 2 mm, Perbunan, for double diaphragm pump top spray	1 6
63479 Flat valve 24 x 19 mm, for SATA double diaphragm pump top spray	3
63487 Carrier rod D 13, 9L for SATA vario top spray, complete w/ O-ring 10.82 x 1.78	5
63495 Valve seal D 48 mm for SATA vario top spray double diaphragm pump	3

Errors, technical modifications and printing errors reserved.

Spare Parts Material Fine Pressure Regulator

Order No./Desc.	
7989	Ball tap (Teflon) with grip, without connection
21998	Pressure plate
22376	Compression screw
78766	Sleeve nut for material fine pressure reducer Vario-Top-Spray
78774	Insert part for material fine pressure regulator SATA vario top spray
78824	Pressure spring for material fine pressure regulator SATA vario top spray
78832	Tappet for material fine pressure reducer Vario-Top-Spray
80283	Diaphragm
80291	Tappet kit, cpl., for SATA material fine pressure reducer no. 80176
19158	Pressure gauge 0-6 bar, 50 mm, g 1/4, scale line each at 0.1 bar



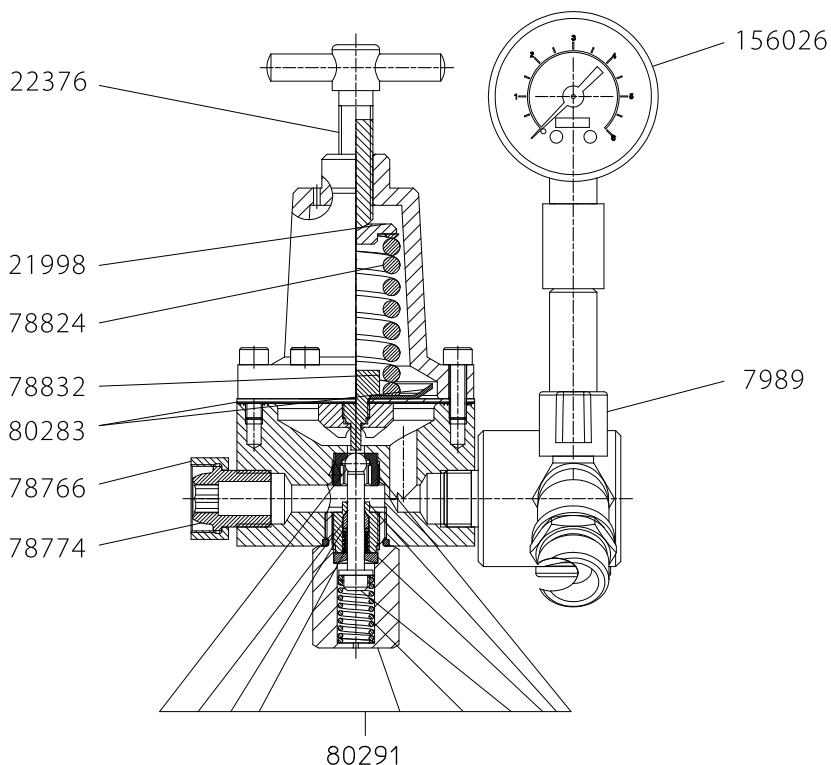

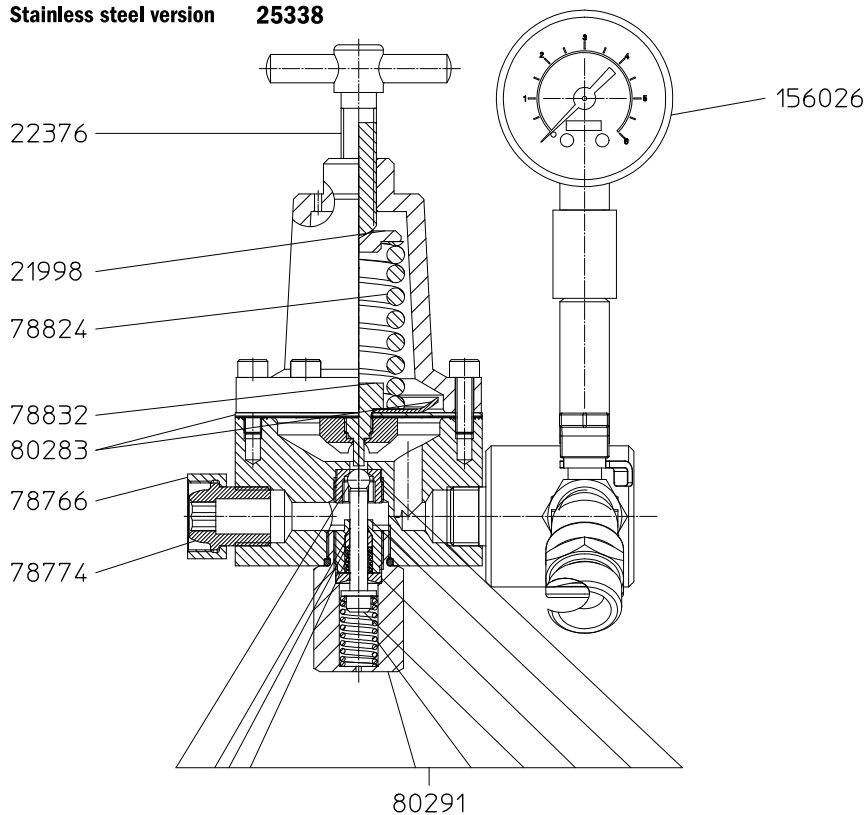

Standard version 24422

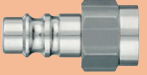

Stainless steel version 25338

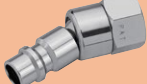

SATA® Quick Couplings

Individual components for the quick coupling system		
6981	SATA HVLP female nipple - 5-pk Quick coupling nipple G 1/4 female thread	
13656	SATA HVLP female nipple - Quick coupling nipple G 1/4 female thread	
53942	SATA HVLP male nipple - Quick coupling nipple G 1/4 male thread	
13599	SATA HVLP female QC - SATA quick coupling 100.14 G 1/4 female thread	
13623	SATA HVLP male QC - Quick coupling 100.14 G 1/4 male thread	
7237	Pack of 2 quick couplings, socket 9 mm, 2 quick coupling nipples G 1/4 female thread, 60 degrees cone.	
13508	Nipple for SATA quick coupling 104/38 G 3/8 male thread	
13557	Hose olive, 9 mm for air quick coupling	
13581	SATA quick coupling 101.38 G 3/8 female thread	
99895	SATA hose connection swivel	

Errors, technical modifications and printing errors reserved.

A close-up photograph of a textured surface, possibly a metal or plastic part, covered in numerous small, clear water droplets. The droplets are of various sizes and are scattered across the surface, which has a fine, grid-like or woven texture. The lighting is soft, creating a gentle gradient from light to dark across the scene.

Dan-Am Co.
**Quality Paint Spray Equipment
and Accessories**

DanAmAir®



DanAm Air is,
Advanced Air Piping System for compressed dry and clean air.

For the professional, home, agriculture shops,
or anywhere you need a clean, efficient air supply.

Easy to install yourself



***SAVINGS of 30-50%
compared to copper installation**



Measure & Cut • Push to Connect

DanAm Air's benefits;

- Energy efficient
- Lower installation costs
- Push-to-connect technology
- Immediate pressurization
- Removable and reusable
- Modular design
- No corrosion
- Leak-free guarantee
- Full bore design
- 1/2" - 6" pipe sizes

DanAm Air is an aluminum compressed airline system that is easily installed with push-to-connect technology, is modular, can be used and reused, and can connect to existing airlines.

Easy Do-It-Yourself Installation

- No pipes to thread
- No soldering

Aluminum is an Efficient Alternative

DanAm Air offers a cost effective, innovative and energy efficient aluminum compressed air pipe system that is easy to assemble, change and expand.

With DAA, self installation is easy. The materials and modular design of a DanAm Air air pipe system makes it quicker and less expensive to install than traditional systems.

DanAm Air's aluminum piping is easier to lift and handle than standard steel piping. The push-to-connect fittings secure connections with a simple push, which is much quicker and safer than soldering copper.



For more information visit:

www.DanAmAir.com

and view our digital catalog

DAA is not only efficient, but also very clean looking, functional and modular so it can be designed for use in any shop.

For a FREE quote call: 800-533-8016

*Savings may vary.

Renovate Your Steel System with DanAm Air

DanAm Air's aluminum pipe ensures a total absence of corrosion. The inner pipe surface consistently delivers clean compressed air. DanAm Air prevents the problems caused by rust, which affects galvanized steel systems. Due to consistent clean quality air, from compressor outlets to machines, DanAm Air's aluminum pipe ensures higher longevity of equipment and avoids frequent changes of filtration elements. DanAm Air can also be integrated into existing copper and steel piping without compromising performance, making it perfect for upgrades or expansion projects. DanAm Air's additional benefits include:



Significant Energy Savings

Compressed air represents one of the largest opportunities for immediate energy savings. Plant management is often surprised to hear that compressed air can represent 20-50% of a plant's electric bill. Plant management is truly amazed when they find out that using an efficient piping system specifically designed for compressed air can reduce their energy bill by 30-60%, many times within a 24-month period.

For instance, a large industrial plant recently redesigned their compressed air system with DanAm Air. This accounted for 35% savings in the plant's monthly energy bill, which paid for the system in 15 months. The plant continues to save by:

- Increased air system reliability
- Reduced maintenance cost and extended equipment life
- Reduced system downtime, increased production rates

The results speak for themselves and show that DanAm Air is the best performing system and the best long-term choice, no matter whether the project is for an extension, the modification of an existing pipe system or a new installation.



An Energy Efficient Solution



Savings Chart	DanAm Air	Threaded Carbon Steel	Copper
	Painted Alum.	Sch 40	Type L
Pipe Schedule			
Material			
Pipe	\$ 3,081.00	\$ 2,970.00	\$ 8,880.00
Fittings	\$ 1,727.00	\$ 642.00	\$ 481.00
Material Total	\$ 4,808.00	\$ 3,612.00	\$ 8,921.00
Labor Hours	22.35	82.21	60.42
Labor Cost at \$65/man hour	\$ 1,459.90	\$ 5,343.65	\$ 3,927.30
Total cost	\$ 6,267.70	\$ 8,955.65	\$ 12,848.30
DanAm Air			
Manhour Savings			
vs Threaded Carbon Steel	73%		
vs Copper	63%		
Total Installed Cost Savings			
vs Threaded Carbon Steel	30%		
vs Copper	51%		
MATERIAL LIST: 500 feet of pipe, 16 elbows, 7 tees, and 10 couplings (unions). Comparison is DanAm Air 1 1/2" s" (40mm) versus 2" pipe. Labor rates from MCAA manual are factored by 0.70, which is typical for estimating field jobs. Pricing subject to change without notice. Alterations Reserved			

For more information visit, DanAmAir.com

Carbon Monoxide Monitors

Carbon Monoxide Monitors

Ensures grade D air quality for personal protection





Technical Data: X767 CO Monitor

Gas detected: CO in compressed air	Power: 110 volt AC
Detection Principle: 3 electrode electrochemical	Operating Temp: 30° - 120°
Alarm: preset to 10 ppm	Dimensions: 4" x 6" x 3.5"
Continuous lifetime operation	Weight: 4.2 lbs
Warranty: 1 year	Powered coated metal housing

Carbon Monoxide Monitor Versions

X767-PLUS	<p>110 volt AC Carbon Monoxide Monitor.</p> <p>Alarm set at 10 ppm with an LCD display</p> <p>Meets 29 CFR 1910.134 requirements for CO monitoring of compressed breathing air.</p> <p>Audible and visual alarms for high CO or sensor failure.</p> <p>RFI filtered from interference of cell phones, two-way radios, etc.</p> <p>LCD digital readout in 1 ppm increments with response time of 10 seconds to 95%</p> <p>Proven reliable performance electrochemical sensor.</p> <p>Calibration recommended every 6 months.</p> <p>Remote alarm options available</p>	
-----------	---	---

Carbon Monoxide Monitor Accessories

X81-1231K	Calibration kit for Carbon Monoxide Monitor	
XA176	Standard 85 db remote alarm for Carbon Monoxide Monitor	
XA176A	Extra loud 100 db remote alarm for Carbon Monoxide Monitor	
XA176B	<p>Extra loud 120 db air horn w/ regulator for Carbon Monoxide Monitor</p> <p>Call for availability (this alarm only)</p>	
XA166	Siren alarm with strobe light	

X144 "ICOM" Individual Carbon Monoxide Monitor

X144	<p>"ICOM", Individual CO Monitor</p> <ul style="list-style-type: none"> ■ Mounts inside the respirator hood ■ Battery powered stand alone unit ■ Weighs less than 1 ounce <p>The battery powered X144 ICOM is a high performance, simple and effective tool for monitoring Carbon Monoxide. A control chip is factory set and programmed to alarm (76db) when the CO level in compressed air exceeds the OSHA standard of 10 ppm. Because it is so tiny, it mounts on the inside of the SATA vision 2000 supplied air respirator hood with a Velcro strip. The X144 ICOM is designed specifically to be affordable and easy to use in any shop. The X144 is small - only 2.4 x 1.4 x 0.6 inches and it weighs less than an ounce. Monitor accuracy is +/-10% of reading at standard conditions between 32° - 122°F. Normal operating life is one year and that can be extended by replacement of the battery and sensor.</p> <p>The instrument may also be returned annually for calibration and battery change at customer expense.</p>	
CR2450N	Battery replacement, purchase locally	

Spare parts Carbon Monoxide Monitors

Part Number	Description	Key #	X747	X757	X758	X767
13623	Male coupling, 1/4"			X		
13656	Female nipple, 1/4"			X		
1816-MC	Male coupling, 1/2" Milton			X		
1817-MN	Male nipple, 1/2" Milton			X		
84798	Plug, brass hollow hex 1/2"			X		
X06-1105	Air Tubing (per foot)	4	X		X	X
X07-6122	O Ring, sensor		X	X		X
X10-0279	Case screw, X758	1			X	
X14-A259	Screwdriver guide bushing			X		
X16-0285K	Bushing, 1/2" x 1/8", brass					X
X17-0001	Air inlet fitting, 1/8" MPT x 1/4" tube	5				X
X17-0005	Elbow fitting, 1/8" MPT x 1/4" tube					X
X17-0282K	Calibration gas inlet	13	X	X	X	X
X17-0285	Flow restrictor, porous metal	7	X		X	X
X17-6251K	Inlet fitting, straight w/porous plug	19			X	
X20-0110K	Case, calibration kit	14				X
X31-0003	Flow meter, replacement	3	X			
X35-6015K	Flow block	12				X
X43-0940	Switch, battery on/off					X
X45-2401K	Plug, repeater buzzer					X
X45-8012K	Battery housing, w/holder					X
X45-8013K	Battery holder					X
X47-1012K	Power cord (X767-PLUS only)	18				X
X47-4012K	Sensor wiring harness, X747		X			
X47-4120K	Sensor cable w/circuit board				X	X
X47-4156	Cord, 50' Buzzer extension					
X52-1020	Alarm buzzer	2	X			
X52-1051K	Alarm buzzer w/18' cable for remote breathing unit					X
X52-A279	Alarm Buzzer w/cable and plug	10				X
X57-A279	Circuit board, main	11				X
X65-2400K	Cell, CO detector	6	X	X	X	X
X81-0062K	Carbon Monoxide test gas cylinder, 10ppm			X	X	
X81-0065K	Carbon Monoxide test gas cylinder, 100ppm	17	X			X
X81-0078K	Nitrogen test gas cylinder 100%	15	X			X
X81-1001K	Regulator Valve	16	X	X	X	X
X81-1051K	Calibration tube, w/monitor connection		X			
X81-1052K	Calibration tube, w/flow meter connection			X	X	X
X81-1230K	Calibration kit, X747 Carbon Monoxide monitor		X			
X81-1231K	Calibration kit, X767 Carbon Monoxide monitor					X
X81-1235K	Calibration kit, X757 & X758 CO monitor			X	X	
X82-0005K	Calibration screwdriver, jewelers			X	X	
X82-0091	Calibration screwdriver, dbl. ended		X			X

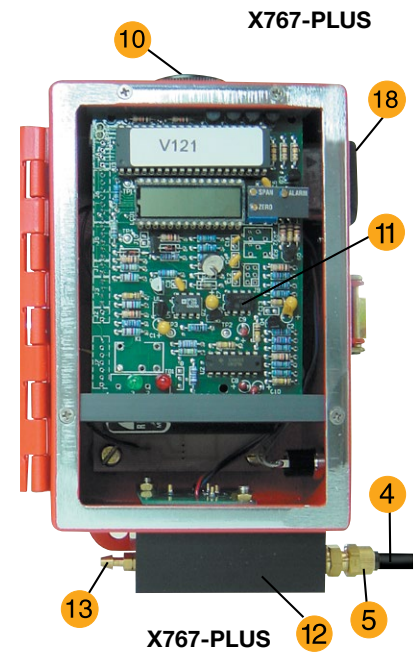

Calibration Kit

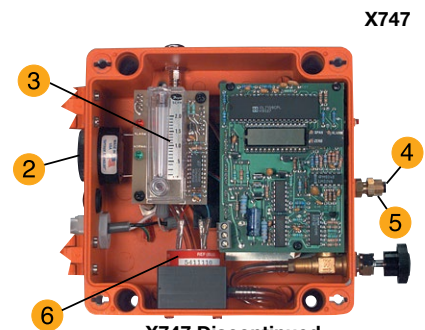

X747 Discontinued and Replaced with X767

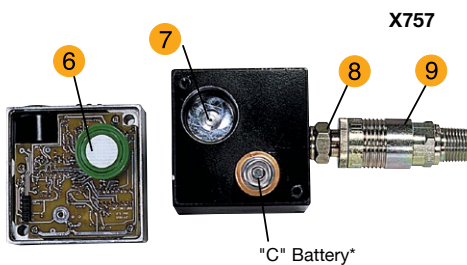



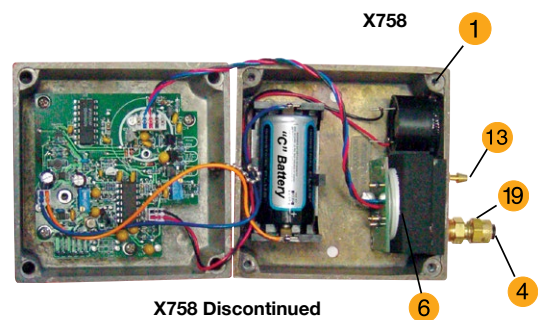





X757 Discontinued



X758 Discontinued
*PURCHASE BATTERIES LOCALLY

Errors, technical modifications and printing errors reserved

Dan-Am Accessories

Gun Cabinets		
95	<p>Large double door lockable gun cabinet</p> <p>Material: 20 gauge steel</p> <p>Storage: 2 shelves, locker, hangers for 7 gravity fed spray guns</p> <p>Measurements: 46 in w x 35 in h x 12 in d / 116 cm x 89 cm x 30.5 cm</p> <p><u>Must be shipped by truck, please call for a freight quote.</u></p> <p><u>FREIGHT CHARGES NOT INCLUDED</u></p>	
96	<p>Small single lockable gun cabinet</p> <p>Material: 20 gauge steel</p> <p>Storage: 1 shelf, and hangers for 7 gravity fed spray guns</p> <p>Measurements: 25 in w x 35 in h x 12 in d / 63 cm x 89 cm x 30.5 cm</p>	
9898-3A	<p>Extra gun shelf holders are available that hold 3 guns or 4 guns. The shelves must be staggered in any order 4 gun or 3 gun so the spray guns are not resting on each other. Fits both cabinets</p> <p>Cabinet three (3) gun holder shelf</p>	
9898-4	<p>Cabinet four (4) gun holder shelf</p>	
Gun Holders		
9890-M	<p>Gun holder for SATAMinijet 3000 B HVLP</p> <p>Suitable for wall mounting, mounting in cabinet or mounting on a 9898 gun holder</p>	
9898-3	Wall mounted 3 gun holder	
9898-4	Wall mounted 4 gun holder	
9898-6	2 x wall mounted 3 gun holder, holds 6 guns total	
9890	<p>Dan-Am Company Bench Mounted Gravity Gun Holder With Built-in Strainer Holder</p> <p>Holds gravity gun perfectly straight for easy straining/refilling. Anodized black aluminum construction. Special plastic channel guide protects air cap horns. Screws to workbench.</p>	
9890-A	Special portable version with heavy metal base for on-site work (shown)	
9890-B	Metal base only	
SATA gun holders		
40188	<p>SATA Wall or Bench Mount Heavy Duty Gravity Gun Holder. Red solvent resistant coating. Also works great for the SATA Mini-Jet. Gravity cup is held in the vertical position for easy refilling. Complete with mounting screws.</p>	
9886	<p>SATA universal wall mount gravity gun holder.</p> <p>This type may be screwed to the wall at various locations for convenient storage.</p>	
Dan-Am Electric Drain Valve		
640525 (1/4")	<p>The EDV has been designed for general purpose applications. The unit is suited for all compressed air system components (after-coolers, dryers, filters, pressure vessels and piping), regardless of their size or capacity—simply adjust the interval and discharge times to suit the particular compressed air system. FPM seals for systems where synthetic lubricants are used are standard. 115 volt. 1 year warranty</p>	
640533 (3/8")		
640550 (1/2")		

Dan-Am Accessories

Dan-Am Kneeler

KNE0002

This handy padded Dan-Am Kneeler will work great for any job requiring you to kneel down on hard surfaces.

Extremely comfortable when working on.....

- Grated paint booth or concrete floors for masking in and painting vehicles
- Collision repair or mechanical jobs low on a vehicle
- Washing or detailing vehicles
- Gardening projects
- Carpentry projects including carpet laying, installing wooden floors, or installing trim
- Plumbing projects when working under cabinets

Very light weight, durable, comfortable, easy to clean with soap and water.

Does not break down in thinner or acetone when wiping off paint overspray.



Dan-Am Hosemate

10102 pair

Designed to guide twisted hoses and electrical cords effortlessly around wheels, the Hosemate slips quickly and easily on any standard size tire. When painting or washing a vehicle the hose glides easily over the surface of the Hosemate. This means the painter can maneuver quickly and freely while applying costly time-sensitive coatings. It also reduces wear and tear on expensive hoses and saves prep and work time.

10101 single

The Hosemate has a multitude of uses. Use it for storing compressed air hoses, garden hoses, ropes, chains, or extension cords. It's not only a great accessory for the body shop, but it can be used around the home and on the farm. Using the Hosemate as a hanger prevents condensation in compressed air hoses. It also reduces the chance of accidents and keeps the work area neat and organized.



Dan-Am Accessories

DanAm Air Vac

DAA1001K

DanAm Air Vac removes foreign objects from wet paint/clearcoat. Eliminate dirt nibs, bugs, lint, hair or other airborne debris right after it lands.

The DAA Vac simply connects to your existing airline in the booth. Open the valve and the air creates a vacuum through the tool. Use the fine clear disposable tips to remove the debris from the wet paint/clearcoat, and use the disposable dropper to put a drop of paint/clearcoat back into the void. The paint/clearcoat will melt into the wet surface and you may have very light sanding and polish for perfection, if any at all.



Kit includes

- 1 DanAm Air Vac w/ball valve
- 1 4' suction hose w/tip
- 12 Tips, clear vacuum
- 1 Dropper





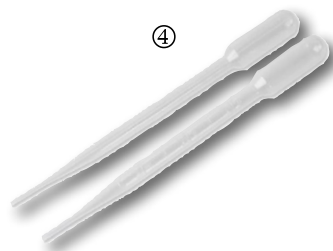
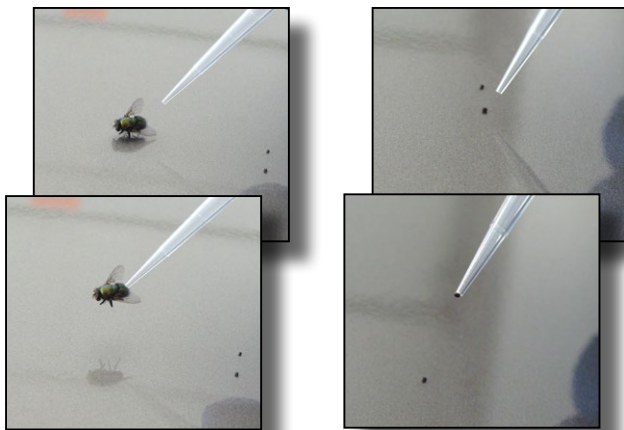



Parts for DanAm Air Vac

Position	Part No.	Description
1	DAA1001K	DanAm Air Vac complete
2	DAA1002T	Clear tips, disposable, 20 pk
3	DAA1003H	Black suction hose, 4'
4	DAA1004D	Dropper, disposable, 5 pk
5	DAA1005V	Ball valve
6	DAA1006BT	Tip, black hose, ea



Errors, technical modifications and printing errors reserved

Dan-Am Hoses

Air Hoses - for use with SPRAY GUNS and supplied air respirators	Vision 2000 1/4" NPT Male Thread	NEW Air Vision 5000 w/Coupler & Nipple	NEW Hose Only with 1/4" BSP Male Thread	
52 in / 1.3 m paint whip hose - to connect SATA spray gun and belt unit	55640	676004	678004	
10 ft / 4.6 m Premoflex non-gassing hose - 3/8 in ID	3366-10	676010	678010	
15 ft / 4.6 m Premoflex non-gassing hose - 3/8 in ID	3366-15	676015	678015	
20 ft / 4.6 m Premoflex non-gassing hose - 3/8 in ID	3366-20	676020	678020	
25 ft / 7.6 m Premoflex non-gassing hose - 3/8 in ID	3366-25	676025	678025	
35 ft / 10.7 m Premoflex non-gassing hose - 3/8 in ID	3366-35	676035	678035	
50 ft / 15.3 m Premoflex non-gassing hose - 3/8 in ID	6633-50	676050	678050	
60 ft / 18.3 m Premoflex non-gassing hose - 3/8 in ID	6633-60	Call	Call	
75 ft / 22.8 m Premoflex non-gassing hose - 3/8 in ID	6633-75	676075	678075	
100 ft / 30.5 m Premoflex non-gassing hose - 3/8 in ID	6633-100	676100	678100	
High Quality Combination Hoses for 2 - 40 l Pressure Tanks and 1:1 Pumps				
675206	6 ft dual hose - 3/8" air hose, 1/4" material hose, female fittings			
675215	15 ft dual hose - 3/8" air hose, 1/4" material hose, female fittings			
675225	25 ft dual hose - 3/8" air hose, 1/4" material hose, female fittings			
675250	50 ft dual hose - 3/8" air hose, 1/4" material hose, female fittings			
675406	6 ft dual hose - 3/8" air hose, 3/8" material hose, female fittings			
675415	15 ft dual hose - 3/8" air hose, 3/8" material hose, female fittings			
675425	25 ft dual hose - 3/8" air hose, 3/8" material hose, female fittings			
675450	50 ft dual hose - 3/8" air hose, 3/8" material hose, female fittings			
675510	10 ft combination hose for SATAminijet 3000 PT, 1/4" air hose, 6mm material tubing, female fittings (SATAminijet 3000 PT only)			
675706	6 ft combination hose for SATAminijet 1000 K (only), 1/4" air hose, 6mm material tubing, female fittings			
675710	10 ft combination hose for SATAminijet 1000 K (only), 1/4" air hose, 6mm material tubing, female fittings			
675715	15 ft combination hose for SATAminijet 1000 K (only), 1/4" air hose, 6mm material tubing, female fittings			
675725	25 ft combination hose for SATAminijet 1000 K (only), 1/4" air hose, 6mm material tubing, female fittings			
High Quality Combination Hoses for High Pressure Pumps				
640225	25 ft / 7.6 m dual hose - 1/4" air hose, 3/16" material hose, female fittings			
640250	50 ft / 15.3 m dual hose - 1/4" air hose, 3/16" material hose, female fittings			
Air and Combination Hoses for SATAminijet 3000 B, SATAgraph 1, 2, 3 & 4, SATAjet 20 B				
32987	9.8 ft / 3 m x 4 mm PVC compressed air hose for SATAgraph and SATAjet 20 B			
S040	6 ft braided hose, 1/8" X 1/4"			
S041	10 foot braided air hose 1/8" X 1/4",			
S042	6 ft braided hose w/moisture trap			
S045	8 ft braided hose w/quick disconnect (shown)			
54353	6.5 ft / 2 m clear PVC compressed air hose for SATAminijet and SATA 20 B. 6 ID x 1/4 female fittings			

For fittings and couplers please see page 157

* Custom hose lengths available - Please call for quote*

EASY-FLEX Panel /Paint Stand

Save Time, Money, and Work with Easy Flex

The FLEXIBLE stand was introduced more than 20 years ago with quality, stability and flexibility in mind with nothing left to chance. Approved and used by several car manufacturers, the FLEXIBLE paint stand saves time, money and makes the painters life easier. Virtually any panel may be painted inside and out in one operation.

Four flexible hook holders ensure a positive grip on the panel. The panel may be rotated to any angle up to nearly 360 degrees. No need to mask and unmask the car making the stand even more economical. Both sides of the panel may be primed or painted. When finished, the stand with the mounted panel can be baked - not the entire car. The FLEXIBLE stand is adjustable from 35 to 55 inches in height. Large, heavy-duty wheels make the stand easy to move about.

Several accessories are available including the Trim and Spoiler kit that allows threaded items to be mounted. Or with the Snap grip accessory, the painter can hang anything - and rotate it. The FLEXIBLE stand with wheels includes horizontal bar, two vertical bars, two vertical extensions, clamps and four mounting hooks. The stand is made of Electro-Galvanized steel and weighs slightly more than 26 lbs and holds up to 220 lbs.



EF190

MULTIFLEX I

MultiFlex I

Flexibility/Versatility

- Pivoting Multi-Directional Bumper Positioning
- Adjustable to nearly 360 degrees
- No pin locking
- Adjusts Vertically/Horizontally to fit any bumper of any size/shape etc
- 5 Securing Options:
 - Vice Grip & Support Plate
 - Vice Grip
 - Steel Wire
 - Strip/Tie Wrap
 - Nut & Bolt

- Maximizing efficiency and workflow

Set up in a few seconds

Adjustable during use, Entire Repair Process can be done with Bumper on Stand

Can be used for smaller parts as well as Bumpers - using our small parts attachments

Like nothing else available! The Most Flexible, Versatile and Efficient Bumper Stand Anywhere!



EF150

MULTIFLEX II

MultiFlex II

Flexibility/Versatility

Any Bumper Position to nearly 360 degrees

Moves one handed

No pin locking

Stops and holds anywhere you need!

Adjusts Vertically/Horizontally to fit any Bumper of any size/shape etc

Quick Securing using Vice Grips - increasing efficiency and maximizing workflow

Set up in a few seconds

Can be used for smaller parts as well as Bumpers - using our small parts attachments

Adjustable during use, entire repair process can be done using stand

More Flexible, Versatile and Efficient than any competing bumper stand in the US Market!



EF110

EASYFLEX

Easy Flex Paint Stand

Flexibility/Versatility

Any panel position nearly 360 degrees

Moves one handed

No pin locking

Stops and holds anywhere you need!

Adjusts Vertically/Horizontally to fit any panel of any size/shape etc

Any Panel and most bumpers - Really Universal!

No need for additional stands for doors, hoods, or fenders, this takes them all!

Unless a shop does a serious amount of bumpers this is the only stand they will need

Can be used for smaller parts as well as panels - using our small parts attachments

Adjustable during use, entire repair process can be done using stand only

The Most Flexible, Versatile and Efficient Universal Panel Stand Anywhere!















Tailgates



EASY-FLEX panel /paint stand

Accessories for Easy Flex Paint Stand

EF200	<p>Trim and Spoiler Kit Includes 4 threaded rods for holding threaded accessories such as spoilers, mirrors, door handles etc, thread adapters and two mounting clamps.</p>		
EF215	<p>Squeeze-out Tension Clamp Kit Spring loaded pressure clamp spreads open to hold parts from the inside. Includes mounting clamp. Excellent for helmets!</p>		
EF230	<p>Hook, extra long, 7"</p>		
EF250	<p>Motorcycle Tank Kit U-shaped hanger with outside lip, grips tank through the filler opening. A threaded eyebolt with counter nut locks gas tank hanger securely for easy painting. Kit includes a 16 1/2" extension bar</p>		
EF260	<p>Wheel Rim Holder Cone shaped design accommodates most any size wheel. The wheel holder mounts on the horizontal bar and locked down. Swivels 180°</p>		
EF270	<p>Locking pliers kit for securely fastening bumpers or other objects</p>		
EF275	<p>Snapgrip Kit Snapgrip mounted on rod firmly holds smaller items in place. Includes mounting clamp.</p>		
EF2300	<p>Xmas tree paint stand only (5 rod holder) Used to mount 5 different mounting brackets that hold small parts for painting at one time</p>		
EF2400	<p>Xmas tree paint stand with 5 holders 3) EF215 Squeeze-out Tension Clamps 2) EF275 Snapgrips</p>		
EF2303	<p>Xmas tree paint stand only, (3 rod holder) Used to mount 3 different mounting brackets that hold small parts for painting at one time</p>		
EF2403	<p>Xmas tree paint stand with 3 holders 1) EF215 Squeeze-out Tension Clamp 2) EF275 Snapgrips</p>		

Spare parts EF110 / EF150 / EF190 EASY-FLEX panel /paint stand

Order No./Desc.	
EF150A	Bumper arm kit (x2) Convert 110 to 150
EF230	7" extra long hook
EF270	Snap grip kit
EF215	Squeeze out clamp
EF240	Hook (single part)
EF275	Snapgrip kit
EF1101	Wheel Leg
EF1102	Wheels (2)
EF1103	Wheel Bolts (2)
EF1104	Leg Brace
EF1105	Frame Bolts (2)
EF1106	Leg
EF1107	Wheel Leg Brace
EF1108	Set Screws (2)
EF1109	Knob (3)
EF1110	Height Bar
EF1111	Cross Bar
EF1112	Counter Nut
EF1113	Brass Plug
EF1114	Locking Knob
EF1115	Cross Bar seals (2), End plug (1)
EF1116	Tool Holder (2)
EF1117	Hooks (4) of EF240
EF1118	Extensions (2)
EF1119	Bumper pad (x2)
EF1120	Tilt clamp
EF1121	Bumper arm holder 90
EF1122	Bumper arm
EF1123	Bumper holding rod
EF1125	Tilt rod
EF1124	Locking Pliers
EF1126	Swivel rod center
EF1127	Small knob for EF1121
EF2312	Xmas tree bracket holder
EF2314	Xmas tree pole
EF2310	Xmas tree base

Base Unit for EF110/EF150/EF190

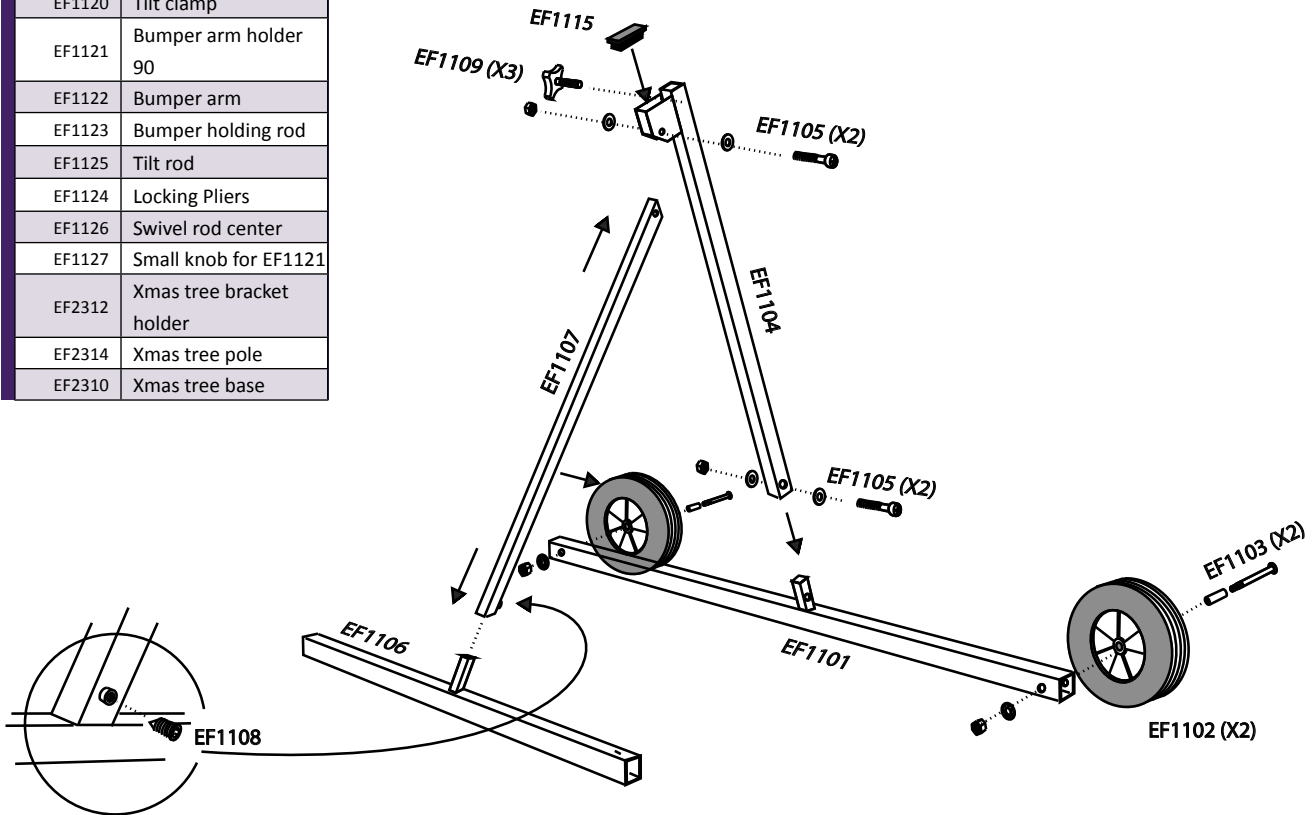
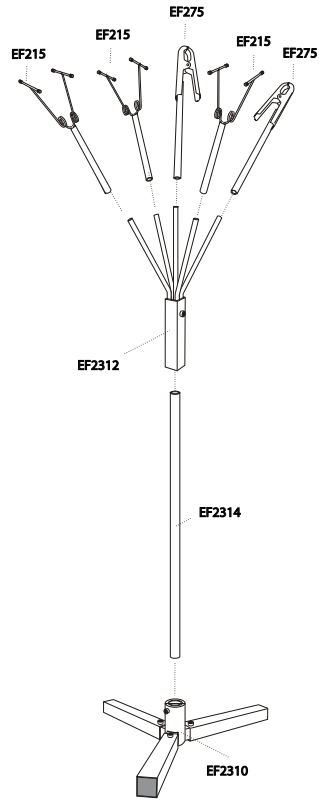

Errors, technical modifications and printing errors reserved

Spare parts EF110 / EF150 / EF190

Upper Unit for EF190

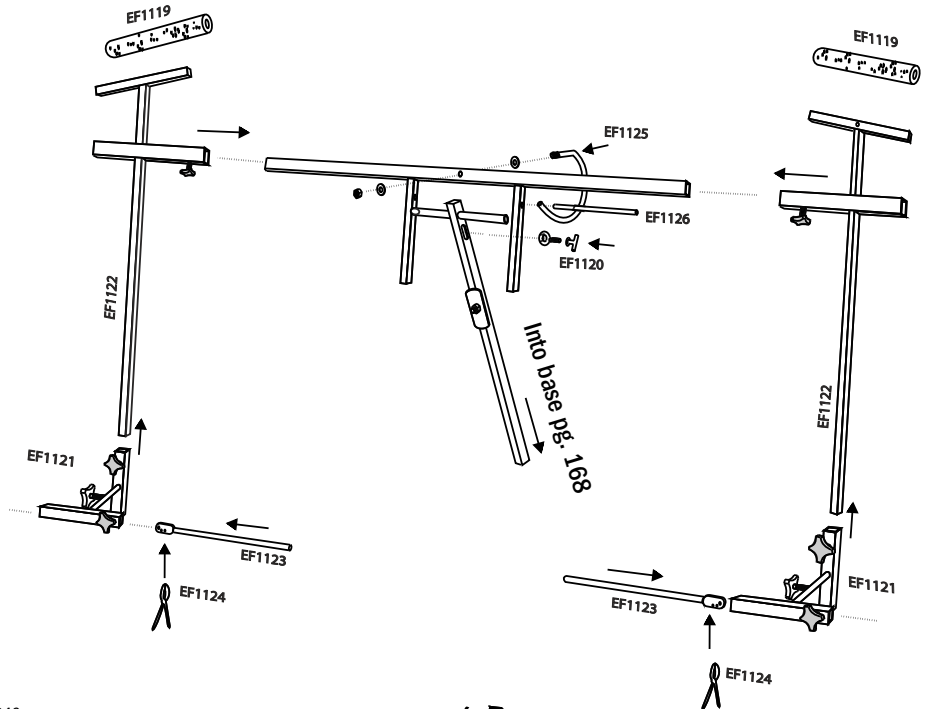

Upper Unit for EF110

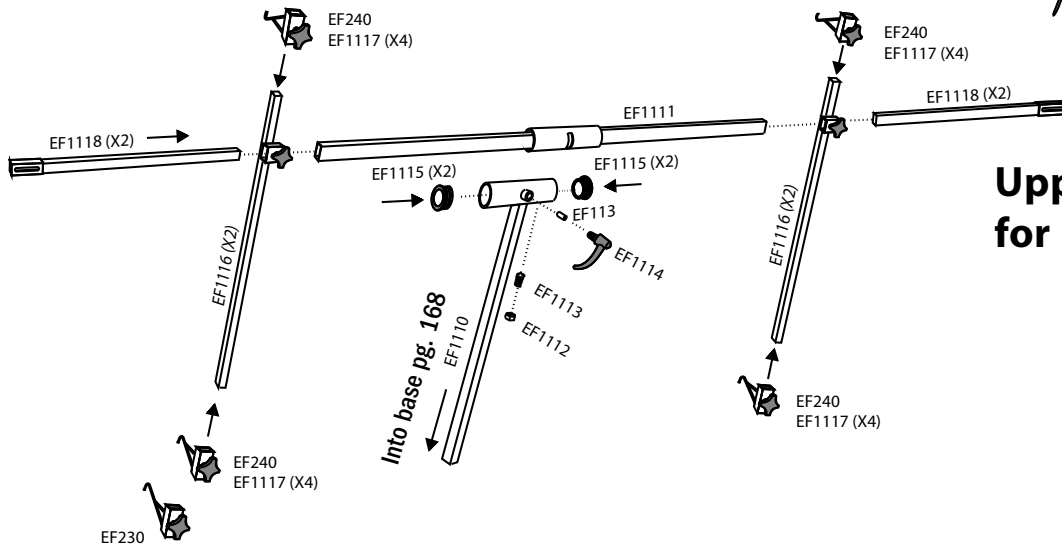

Upper Unit for EF150

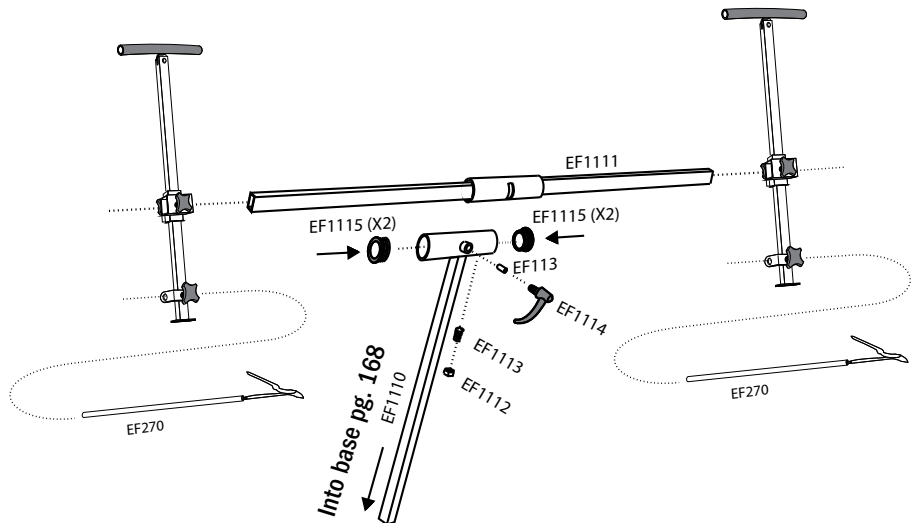

Errors, technical modifications and printing errors reserved

Dan-Am Handy Stand 702100

Dan-Am Handy stand uses;

- Bodywork
- Sanding
- Priming
- Painting
- Polishing

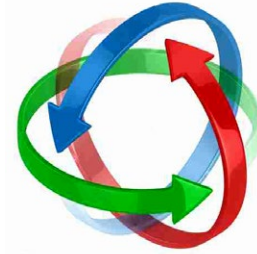

702100

Dan-Am Handy paint stand

Flexibility/Versatility

- Pivoting Multi-Directional Part Positioning
 - Adjustable to nearly 360 degrees horizontal and vertical
 - Maximizing efficiency and workflow
 - Set up in a few seconds
 - Adjustable during use, entire process can be done with object on stand
 - Can be used for smaller parts as well as fender, tanks and helmets
 - Locking casters so Handy Stand will not move during use
 - Rubber tipped adjustment rods are removable for full access during painting and polishing
 - Tripod base folds up for storage or easy maneuvering through doors
- Like nothing else available!



Parts Dan-Am Handy Stand 702100

DA 702100		
Position	Part No.	Description
1	702101	Tripod base
2	702102	Stand leg
3	702103	Mid tube
4	702104	Swivel coupler
5	702105	Knuckle
6	702106	Pivot bracket
7	702107	Knuckle bushing
8	702108	Crossbar
9	702109	Handle rod
10	702110	Spring clamp, 3"
11	702111	Caster wheel w/lock down, 3"
12	702112	Comfort grip ball knob
13	702113	Knob, three arm
14	702114	Hex flange lock nut, 1/2-13
15	702115	Washer, flat, 3/8"
16	702116	Hex cap screw 3/8-16 x 2.50
17	702117	Hex cap screw 3/8-16 x 2.00
18	702118	Hex cap screw 3/8-16 x 1.75
19	702119	Hex nylon nut, 3/8-16
20	702120	Hex skt cap screw, 3/8-16 x 1.5
21	702121	Toggle screw
22	702122	Clamp spacer
9 & 12	702130	Handle rod w/cushion ball knob
	702132	Spring clamp w/hardware, 3", (1x)
	702134	Pivot head assembly complete

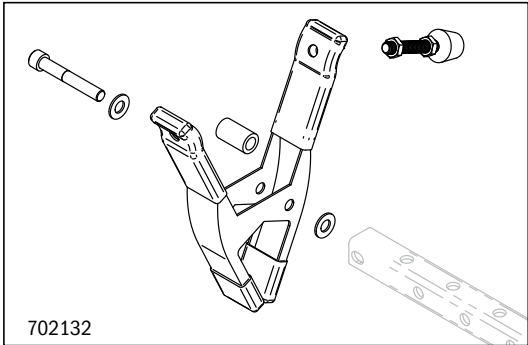
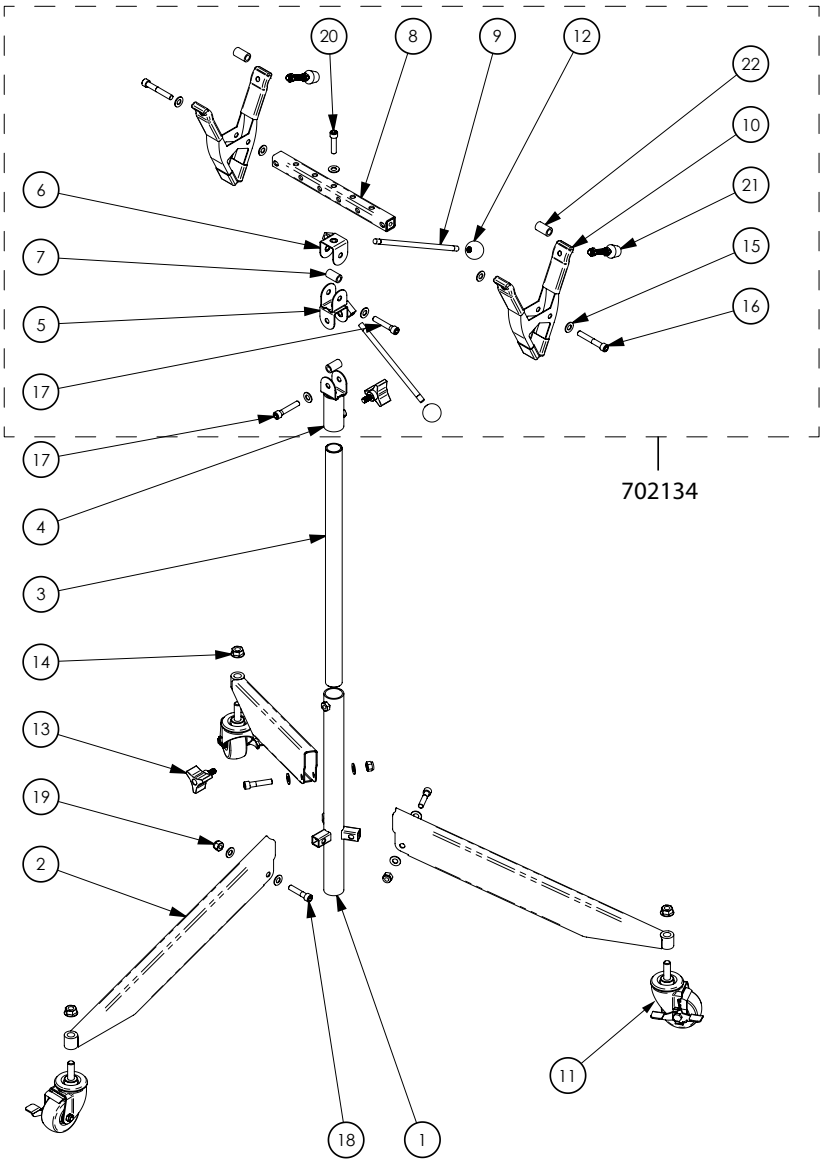

Errors, technical modifications and printing errors reserved

Dan-Am Pressure Pots

2.0L pressure pots

Pressure tanks are a system for direct material storage and delivering a continuous pressurized material flow to the spray gun. A pressure tank system offers the advantages of large surface performance, low weight of the spray gun and continuous operation without refilling. Dan-Am pressure tanks are supplied complete with pressure regulator and over pressure valve. Conventional or HVLP guns may be used with pressure tanks.

2.0L pressure pot - Aluminum

670200 Dan-Am 2 liter aluminum pressure pot, complete with deck, regulator and tank



2.0L pressure pot - Stainless Steel

670400 Dan-Am 2 liter stainless steel pot, complete with deck, regulator and tank



Technical

Specifications	Std Version	SS Version
Max Cup Pressure	50 psi/3.5 BAR	50 psi/3.5 BAR
Max Operating Pressure	35 psi/2.4 BAR	35 psi/2.4 BAR
Overall Height	17 3/4" / 450 mm	19" / 485 mm
Base Diameter	5 1/8" / 130 mm	5 1/8" / 130 mm
Air Inlet	1/4 NPS male	1/4 NPS male
Air Outlet	1/4 NPS male	1/4 NPS male
Material Outlet	3/8 NPS male	3/8 NPS male
Fluid Capacity	2.1 qt/2 Liter	2.1 qt/2 Liter
Weight	3 lbs 14 oz/1.76 kg	5 lbs 8 oz/2.5 kg

2-Liter Shoulder Harness

Special shoulder harness and waist belt holds and stabilizes the 2-liter pressure tank. It allows hands free work by the painter

Order Number 5868

Waist Belt Only

Order Number 13920



Hoses page 167

2.0L Aluminum Pressure tank w/Sata Spray gun and 6 ft dual hose

Spray gun/Nozzle size	.05	0.8	1.0	1.1	1.2	1.3	Specify different nozzle
SATAjet 3000 K HVLP	—	670297	670296	—	670298	—	670296
SATAjet 3000 K RP	—	670293	—	670294	—	670295	670294
SATAjet 1000 K HVLP	—	670260	670261	—	670262	—	670260
SATAjet 1000 K RP	—	670265	—	670266	—	670267	670265
SATAminijet 1000 K HVLP	670270	670271	670272	—	670273	—	
SATAminijet 1000 K RP	670275	670276	670277	—	670278	—	

Includes: 1) Spray gun, 1) 670200, 2.0L aluminum pressure pot, 1) Stainless steel paint pipe, 1) 6ft dual hose

Spare Parts Dan-Am Pressure Pots

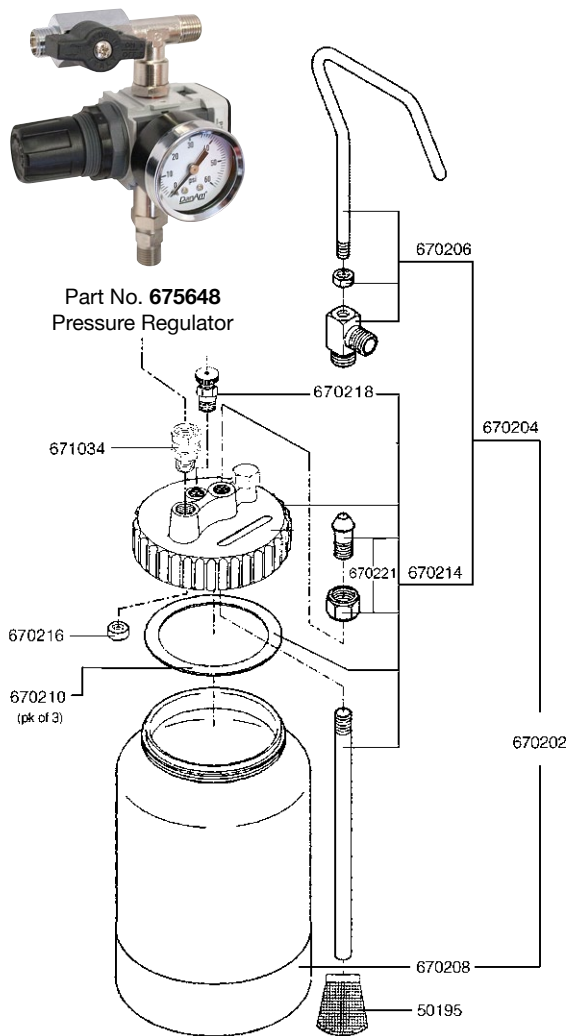

670200 Aluminum 2.0L pot

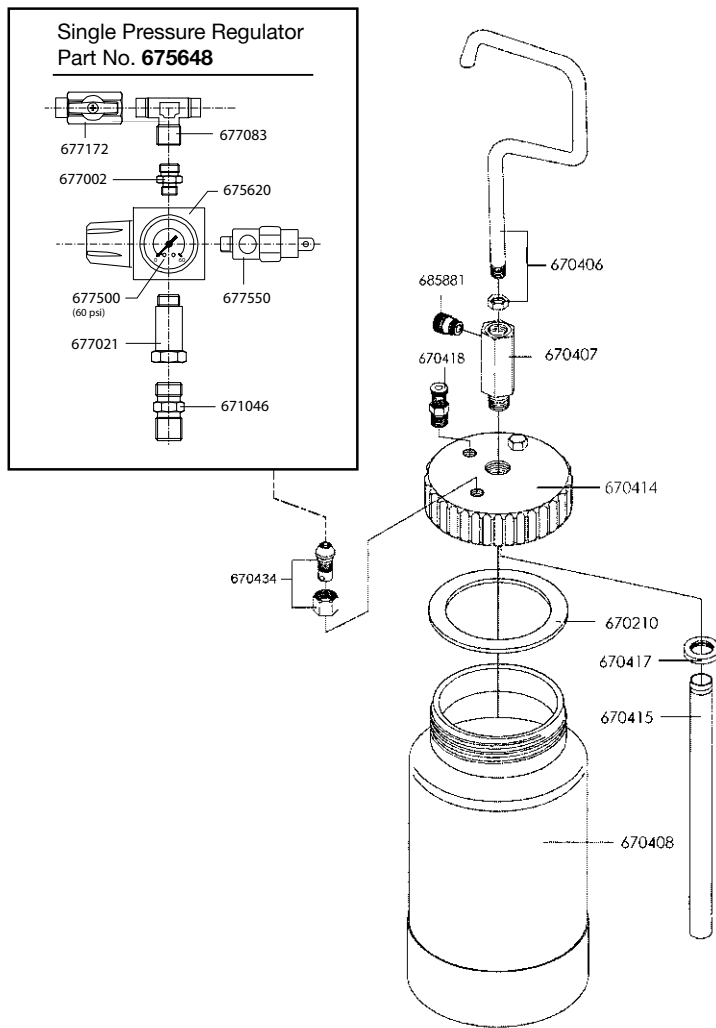

670400 Stainless Steel pot

670200 Aluminum 2.0L pot	
50195	Sieve, pk of 2 (optional)
670202	Pot complete w/o regulator
670204	Deck complete w/o regulator
670206	Material outlet/handle assem.
670208	Pressure cup, 2 liter
670210	Deck gasket, pk of 3
670214	Deck Assembly
670216	Check valve insert (optional)
670218	Pressure release valve
670219	Viton O-ring for 670218
670221	Material outlet fitting
671046	Check valve
675620	Regulator body, 1/4"
677002	Male hex nipple, 1/4"
677021	Extension, 1/4"
677062	Street elbow, 1/8"
677063	Street elbow, 1/4"
677083	Tee fitting, 1/4"
677172	Mini ball valve, 1/4"
677500	Gauge, 1-1/2", 60 psi
677550	Over pressure valve, 35 psi
675648	Regulator assembly, complete

670400 Stainless Steel 2.0L pot	
670400	Pressure pot cpl., w/regulator
670406	Handle w/nut
670407	Material outlet
670408	Tank only
670414	Deck only
670415	Fluid pick-up tube
670417	Nut, fluid pick-up tube
670418	Pressure release valve
670430	Regulator assembly, complete
670434	Air inlet fitting
671046	Check valve
671046	Check valve, 1/4"
671050	Regulator repair kit
675620	Regulator body, 1/4"
675648	Regulator assembly, complete
677002	Male hex nipple, 1/4"
677021	Extension, 1/4"
677083	Tee fitting, 1/4"
677172	Mini ball valve, 1/4"
677500	Gauge, 1-1/2", 60 psi
675648	Regulator assembly, complete
685881	Material outlet fitting

Use for pots with serial number above 2-00001

Errors, technical modifications and printing errors reserved

Dan-Am 10 - 20 Liter Pressure Tanks

10 - 20 Liter Pressure Tank

Dan-Am Company offers a quality line of pressure tanks from 10 to 40 liter. These cost-effective tanks are supplied complete with a quality regulator, over-pressure valve, back-check valve and fluid shut-off valve. Dan-Am models include 10 liter pressure tanks with single or double pressure regulator either plain, with manual stirrer or with pneumatic stirrer. Other 20 and 40 liter variations are also offered with single or double pressure regulator. Tanks are mounted on wheels for ease of handling and mobility.

10 Liter pressure tank

671100	10 l pressure pot w/ single regulator, over-pressure valve, back check valve, fluid shut off valve w/o stirrer	
681100	10 l pressure pot w/ double regulator, over-pressure valve, back check valve, fluid shut off valve w/o stirrer	
671200	10 l pressure pot w/ single regulator, over-pressure valve, back check valve, fluid shut off valve and manual agitator	
681200	10 l pressure pot w/ double regulator, over-pressure valve, back check valve, fluid shut off valve and manual agitator	
671300	10 l pressure pot w/ single regulator, over-pressure valve, back check valve, fluid shut off valve and pneumatic agitator	
681300	10 l pressure pot w/ double regulator, over-pressure valve, back check valve, fluid shut off valve and pneumatic agitator	



20 Liter pressure tank

682100	20L pressure pot w/ double regulator, over-pressure valve, back check valve, fluid shut off valve w/o stirrer	
672200	20L pressure pot w/ single regulator, over-pressure valve, back check valve, fluid shut off valve and manual agitator	
682200	20L pressure pot w/ double regulator, over-pressure valve, back check valve, fluid shut off valve and manual agitator	
672300	20L pressure pot w/ single regulator, over-pressure valve, back check valve, fluid shut off valve and pneumatic agitator	
682300	20L pressure pot w/ double regulator, over-pressure valve, back check valve, fluid shut off valve and pneumatic agitator	

40 Liter pressure tank

674300	40L pressure pot w/ single regulator, over-pressure valve, back check valve, fluid shut off valve and pneumatic agitator	
684300	40L pressure pot w/ double regulator, over-pressure valve, back check valve, fluid shut off valve and pneumatic agitator	

Accessories for pressure tanks

671012	10L Pressure tank disposable liner, 12 pack	
671060	10L Pressure tank disposable liner, 60 pack	
672012	20L Pressure tank disposable liner, 12 pack	
672024	20L Pressure tank disposable liner, 24 pack	

See page 167 for hoses

Spare Parts Dan-Am 10 Liter Pressure Tank

Order No./Desc.	
671001	Pressure tank, 10 L
671002HD	Wheel assembly
671003	Swing bolt assembly
671004	Fluid tube
671005	Fluid sieve kit
671006	Tank lid
671007	Lid gasket
671008	Handle
671009	Pressure relief valve
671010	Secondary over pressure release valve
671011	Fluid Valve Assembly, single
671012	Disposable liner, 10L, Pk of 12
671034	Swivel Connector, Male/Female
671045C	10L deck, w/o regulator, complete
671060	Disposable liner, 10L, Pk of 60
671071	Fluid outlet
671072	Fluid sieve housing

671045C 10 Liter deck, W/O regulator, (includes everything shown below)

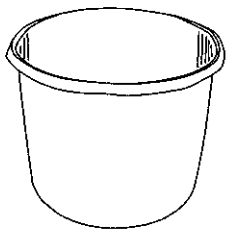
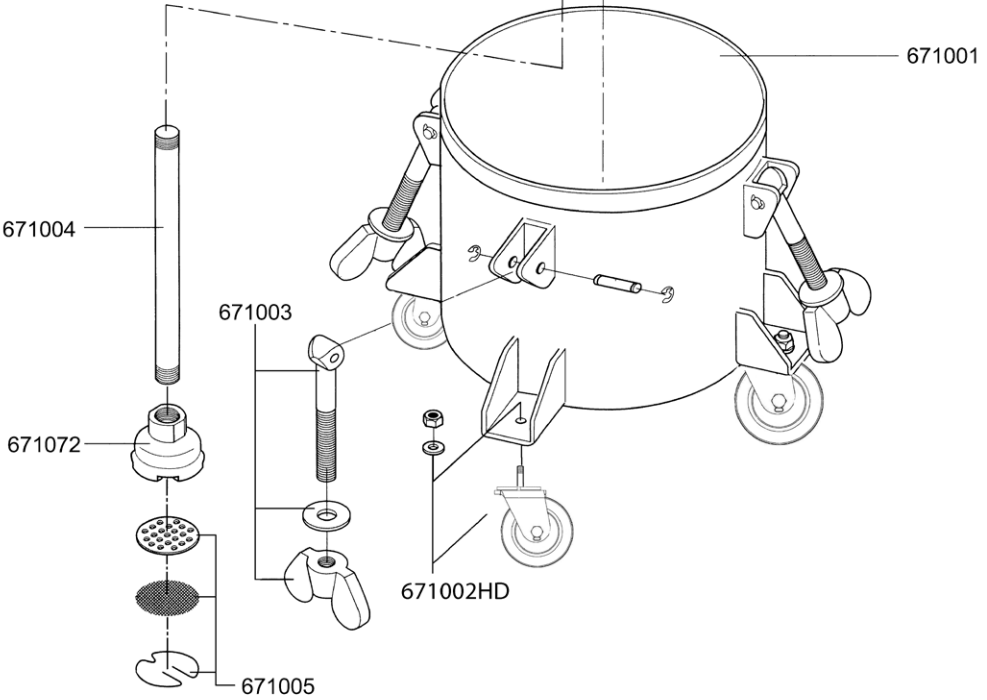
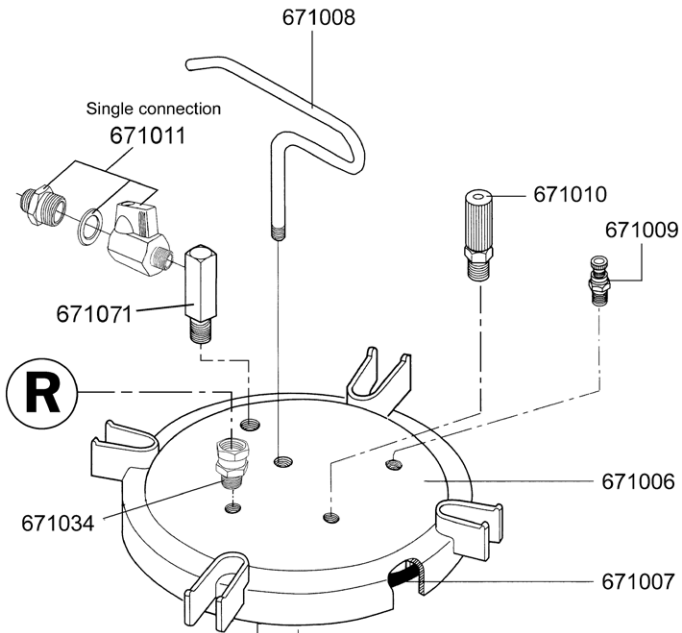

10L disposable liners

671012 Pk of 12
671060 Pk of 60

(R) = Regulator
See page 180, 181

Errors, technical modifications and printing errors reserved

Spare Parts Dan-Am 10 Liter Pressure Tank Lid

Order No./Desc.	
671007	Lid gasket
671009	Pressure relief valve
671010	Secondary over pressure release valve
671011	Fluid valve assembly
671019	Manual agitator shaft
671020	Manual crank base
671021	Manual crank handle assembly
671022	Parts guard assembly
671023	Pneumatic agitator shaft
371024	Motor base assembly
671025	Connecting bushing assembly
671026	Air motor
671033	Agitator air line assembly
671034	Swivel connector, male/female
671035	Tank lid
671071	Fluid outlet
671045	10L deck w/crank w/o reg, complete lid
671045A	10L deck w/air agitator, w/o reg, complete lid
671073	Manual agitator propeller w/bolt
671074	Pneumatic agitator propeller w/bolt
671075	Agitator base nut
671076	Manual agitator shaft lock collar w/bolt
671077	Agitator base gaskets
671078	Pneumatic agitator shaft lock collar assembly
671079	O-ring, Manual agitator base, pack of 2
671080	O-ring, Pneumatic agitator base, pack of 2

Manual Crank Agitator Version

671045 10 Liter deck, W/crank, W/O regulator, (includes everything shown below)

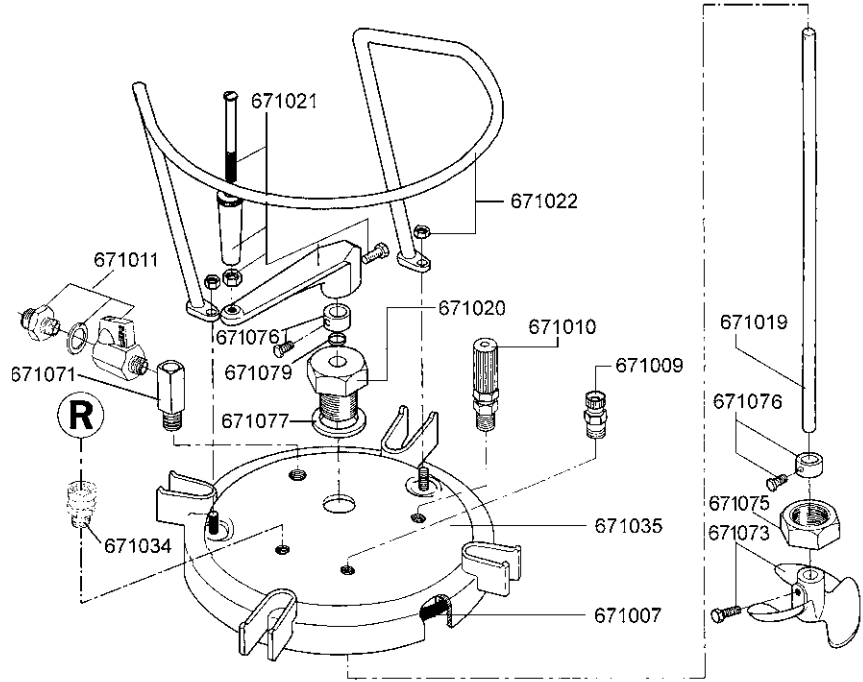

Pneumatic Air Agitator Version

671045A 10 Liter deck, W/air agitator, W/O regulator, (includes everything shown below)

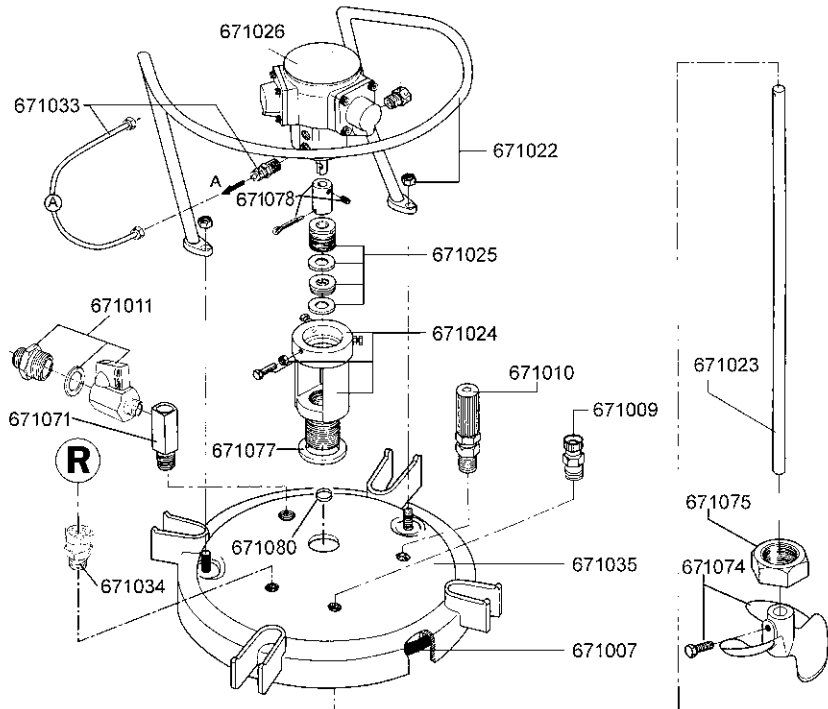

(R) = Regulator
See page 180, 181

Errors, technical modifications and printing errors reserved

Spare Parts Dan-Am 20 & 40 Liter Pressure Tank Lid

Order No./Desc.	
671002HD	Wheel assembly
671003	Swing bolt assembly
671008	Handle
671009	Pressure relief valve
671010	Secondary over-pressure release valve
671011	Fluid valve assembly
671020	Manual crank base
671021	Manual crank handle
671024	Motor base assemble
671025	Connecting bushing assm.
671026	Air motor
671030	Plug, male
671033	Agitator air line assembly
671034	Swivel connector, male/female
671036	Muffler
671075	Agitator base nut
671076	Manual agitator shaft lock
671077	Agitator base gasket
671078	Pneumatic agitator shaft
671079	O ring, Manual agitator base, (pk of 2)
671080	O ring, Air agitator base, (pk of 2)
672001	Pressure tank, 20-Liter
672002	Fluid tube, 20L
672003	Fluid sieve kit, 20L
672005	Tank lid
672006	Lid gasket
672008	Cap screw
672009	O Ring
672010	Manual agitator shaft, 20-Liter
672011	Parts guard assembly
672012	Disposable liner, 20L Pk of 12
672013	Pneumatic agitator shaft
672024	Disposable liner, 20L Pk of 60
672071	Fluid outlet
672072	Fluid sieve housing
672073	Hand agitator paddle, w/bolt
672074	Pneumatic agitator propeller
674001	Pressure tank, 40-Liter
674002	Fluid tube, 40L
674004	Manual agitator shaft, 40-Liter
674005	Pneumatic agitator shaft, 40L

Errors, technical modifications and printing errors reserved

(R) = Regulator, see page 180, 181

20 Liter Manual Crank Agitators (20L only)

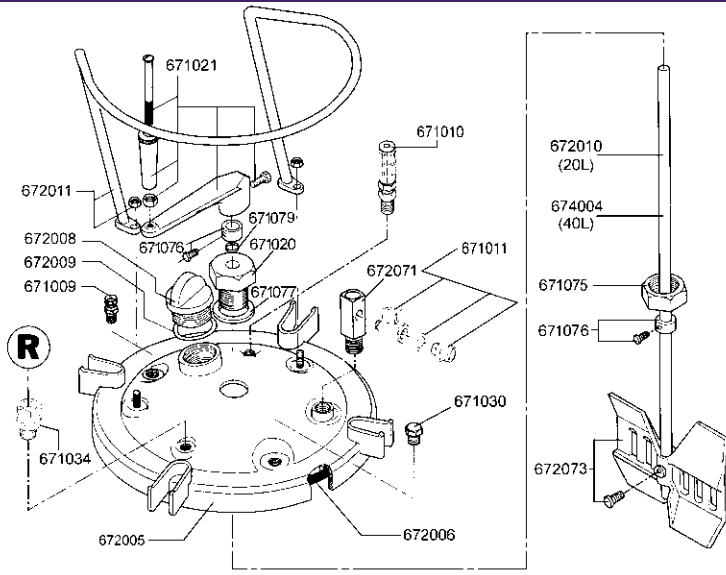

Pneumatic Air Agitator 20L or 40L

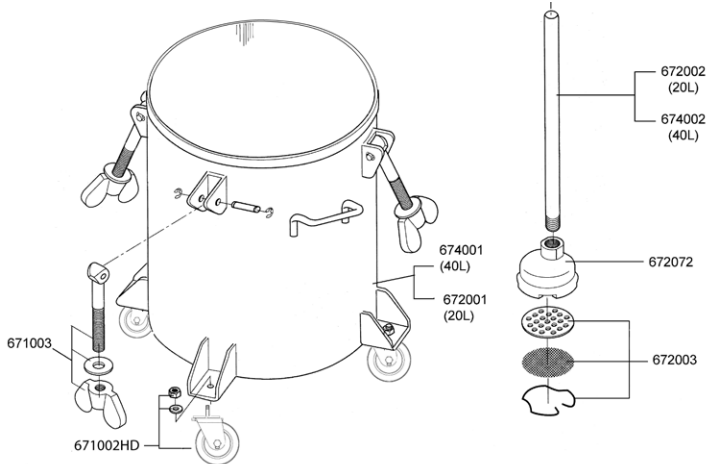
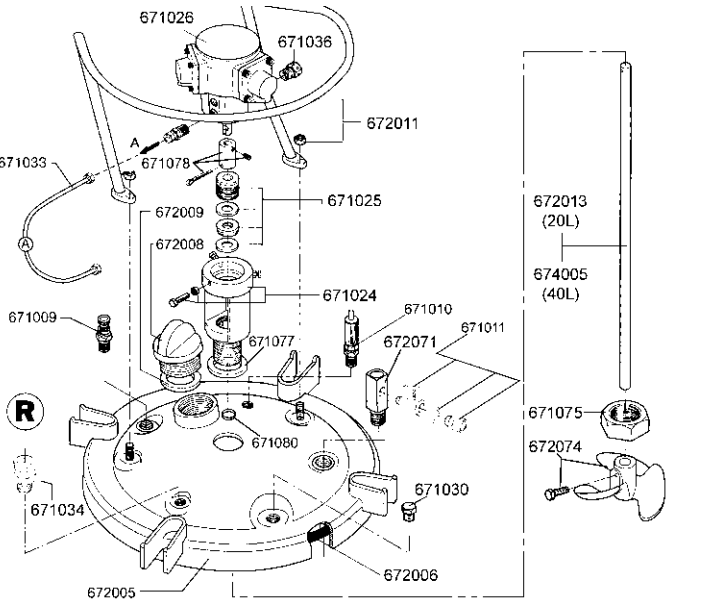

Parts Pressure tank regulators 675640 & 675642

New body style - April 2013



675640 Single regulator for Std and manual stir tanks, 10, 20, & 40L

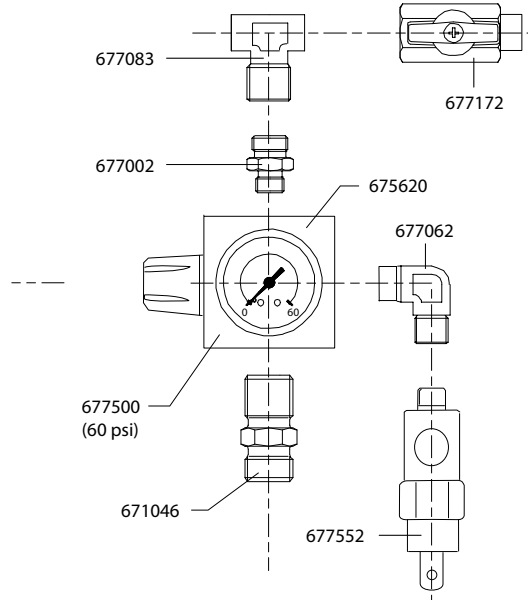

Order No./Desc.

671046	Check valve
675620	Regulator body, 1/4"
677002	Male hex nipple, 1/4"
677062	Street elbow, 1/8"
677063	Street elbow, 1/4"
677083	Tee fitting, 1/4"
677172	Mini ball valve, 1/4"
677500	Gauge, 1-1/2", 60 PSI
677502	Gauge, 1-1/2", 100 PSI
677552	Over pressure valve, 60psi

675642 Dual regulator for std and manual stir tank

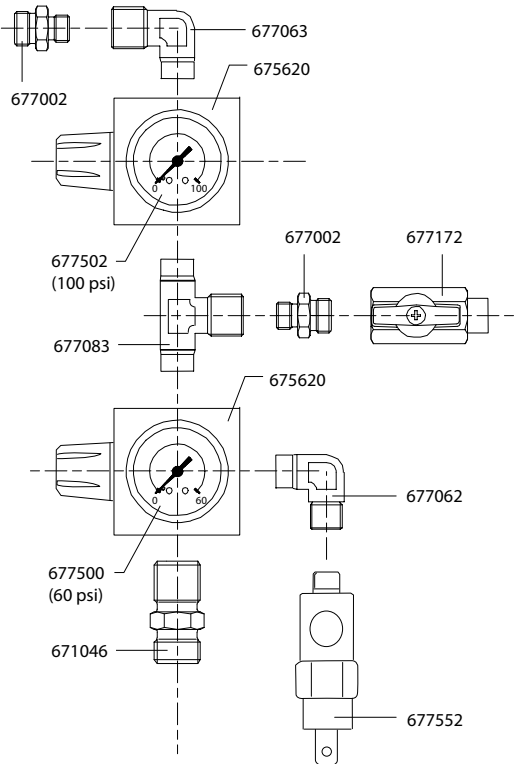

Errors, technical modifications and printing errors reserved

Parts Pressure tank regulators 675644 & 675646

New body style - April 2013



675644 Single regulator for Air Agitated tanks, 10, 20, & 40L

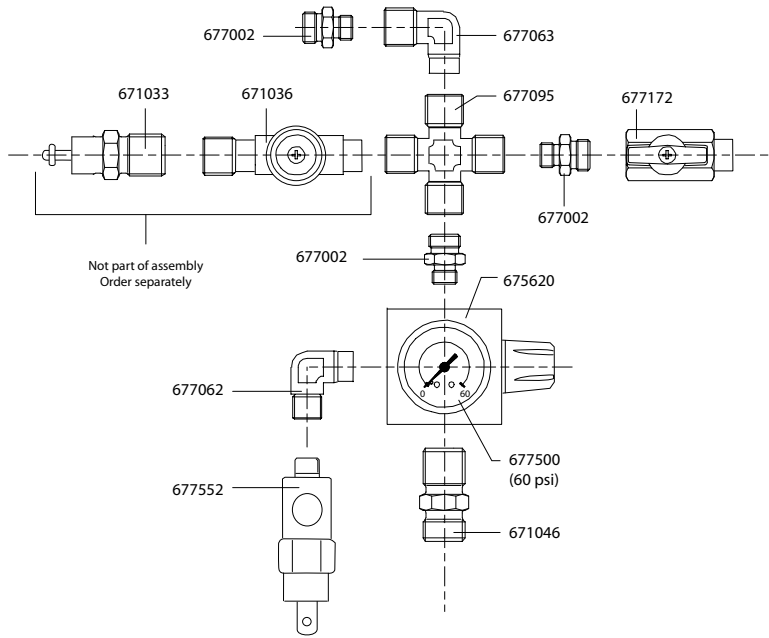

Order No./Desc.	
671033	Agitator airline assembly (includes hose and fasteners)
671036	Agitator shut off valve
671046	Check valve
675620	Regulator body, 1/4"
677002	Hex nipple, 1/4"
677062	Street elbow, 1/8"
677063	Street elbow, 1/4"
677095	Female cross
677172	Mini ball valve, 1/4"
677500	Gauge, 60 PSI, 1-1/2"
677502	Gauge, 100 PSI, 1-1/2"
677552	Over pressure valve, 60psi

675646 Dual regulator for Air Agitated tanks

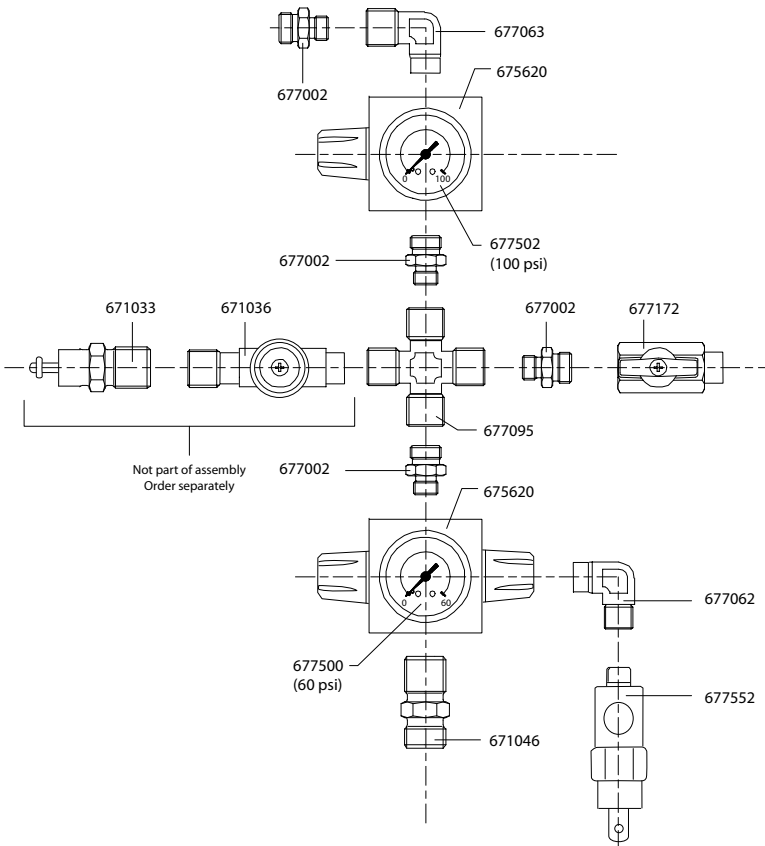

Errors, technical modifications and printing errors reserved

Dan-Am 7232 high pressure pump

Dan-Am 7232

The Dan-Am air-assisted airless piston pump allows the applicator to coat large surfaces rapidly regardless of materials used. That makes the Dan-Am air-assisted airless piston pump suitable for the marine, aviation and miscellaneous motor manufacturing industry.

The Dan-Am air-assisted airless pump system provides low overspray and features stainless steel construction making it suitable for waterborne material.

Trouble free handling, long service and cleaning simplicity is what characterizes the Dan-Am Air Assisted Airless system.

Dan-Am 7232

0641371 Dan-Am Air Assist high pressure pump stainless steel version, w/ cart, High-pressure filter, single gun connection, and grounding wire

Technical Data

Model	7232
Max. free-flow output in liters/min (gal./min)	11 (2.9)
Pressure ratio	32:1
Output per cycle in ccm (fl.oz.)	72 (2.5)
Max. inlet air pressure in bar (psi)	8 (116)
Max. material outlet pressure in bar (psi)	256 (3731)
Approx. air consumption in liter/min. (cu.ft./min)*	311 (11)

*40 cycles per minute at 6 bar (87 psi) inlet pressure



SATAjet 3000 K spray mix

Technical Data	Max. operating pressure atomization air: 10.0 bar / 145 psi
	Max. operating pressure material: 250.0 bar / 3,625 psi
	Weight incl. material filter: 650 g / 23 oz.

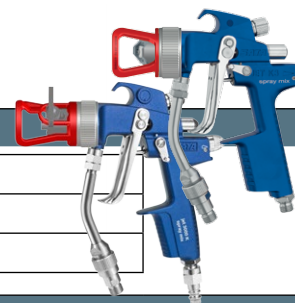

Spray mix gun

120006 SATAjet 3000 K spray with paint tube, strainer 100 mesh, and nozzle set (specify material nozzle size)



Spray mix gun w/ Reversing switch

120014 SATAjet 3000 K spray with paint tube, strainer 100 mesh, and reversing nozzle (specify reversing nozzle size)

207530 Reversing switch kit for SATAjet 3000 K spray mix w/out reversing nozzle

Using a reversing nozzle requires a "one time" purchase of the reversing switch. Part Number 207530

Accessories Dan-Am 7232 high pressure pump

Accessories		
0627434	5 gal. flexible suction tube, stainless steel	
0643901	55 gal. flexible suction tube, stainless steel	
0411329	Stainless steel sieve, flex suction hose M20 (standard)	
0411337	M30	
0411345	M50	
0411353	M70	
0648247	Inlet filter/regulator, w/oiler	
675660	Spray gun regulator, standard single spray gun	
675662	Spray gun regulator for 2nd gun option	
0643930	High pressure filter	
0162787	Filter sieve, 50 msh for high pressure filter #0643930	
0162779	Filter sieve, 70 msh for high pressure filter #0643930	
640225	25 ft dual HP hoses (rated 5000 psi)	
640250	50 ft dual HP hoses (rated 5000 psi)	
0632579	Pneumatic oil for automatic oiler	
0163333	Throat seal lube for material pump	
0474487	Ground wire	

Parts Dan-Am 7232 high pressure air motor

POS	PART NO.	QTY	CODE	DESCRIPTION
1.	0475297	3		dome nut
2.	0460214	3		washer
3.	0641317	1		cover
4.	0641550	3		threaded bolt assembly consisting of pos. 4.1-4.2
4.1	0460192	6		nut
4.2	0641320	3		threaded bolt
5.	0641314	1		safety plate
6.	0474932	1		disc
7.	0641318	1		control cylinder
8.	0310182	4	W, S, R	o-ring
9.	0641151	1		control housing assembly
10.	0460192	2	R	nut
11.	0641327	1	W, R	control piston assembly
12.	0641319	1		control axle
13.	0475076	1		alignment, insert
14.	0475041	1	W, R	dampening spacer
15.	0494054	1		disc
16.	0480258	1	W, R	carrier assembly
17.	0494054	1		disc
18.	0475041	1	W, R	dampening spacer
19.	0493961	1		retaining ring
20.	0493953	1		disc
21.	0460184	2		nut
22.	0460362	2		threaded pin
23.	0641324	6	W, S, R	o-ring
24.	0475297	4		dome nut
25.	0460214	4		washer
(26.)	0611891	1		safety valve
27.	0641325	1		upper part cpl.
28.	0641331	1		air muffler assembly
29.	0460214	2		washer
30.	0470325	2	W	toggle
31.	0473081	2	W	toggle bearing
32.	0411876	2	W	spring
33.	0475122	2		bearing bush
34.	0641486	4		threaded bolt
35.	0482471	1	W, S, R	bush assembly
(36.)	0489026	1		filler neck assembly
37.	0460214	4		washer
38.	0475297	4		dome nut
39.	0475114	1	W, S, R	seal
40.	0461334	1	R	retaining ring
41.	0311391	1	W, S, R	o-ring
42.	0475149	1		piston plate
43.	0475157	1	W, S, R	guide ring
44.	0477281	1	W, S, R	o-ring
45.	0475165	1	W, R	disc
46.	0641485	1	W, R	guide axle assembly
47.	0641487	1	W	motor axle
48.	0311405	1	W, S, R	o-ring
49.	0641488	1	W	cylinder
50.	0311405	1	W, S, R	o-ring
51.	0631431	2	W, S, R	o-ring
52.	0639014	2		air inlet pipe
53.	0473367	1	R	retaining ring
54.	0631431	2	W, S, R	o-ring
(55.)	0644436	1		elbow
56.	0641326	1		bottom assembly
	0641491		R	Seal kit
	0641490			Repair kit

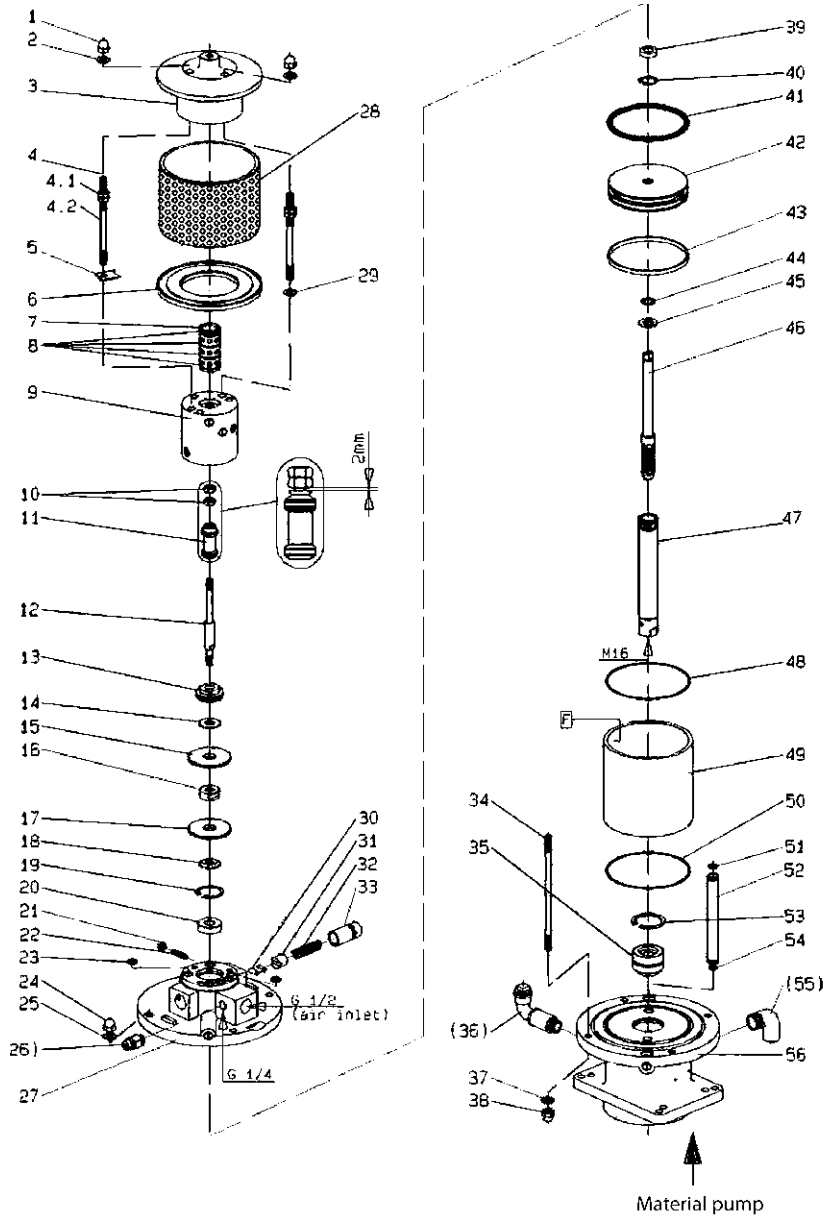

W = Wear part
 S = Included in Seal kit
 R = Included in Repair kit
 Pos. No. marked with () are not part of assembly shown

Errors, technical modifications and printing errors reserved

Parts Dan-Am 7232 high pressure material pump

POS	PART NO.	QTY	CODE	DESCRIPTION
(1.)	0641493	1	S,R	o-ring
2.	0646931	1		high pressure head
(3.)	0163686	1		drain valve assembly consisting of pos. (3.1)-(3.3)
(3.1)	0210714	1		draining screw
(3.2)	0310239	1	S, R	o-ring
(3.3)	0221759	1		valve housing
4.	0641430	1		connecting ring
(5.)	0477184	4		screw
6.	0641443	1		saddle ring
7.	0641449	1	W,R	packing ring set mixed consisting of pos. (7.1) - (7.4)
7.1	0630062	1	W,R	packing ring teflon
7.2	0631811	1	W,R	packing ring leather
7.3	0630062	1	W,R	packing ring teflon
7.4	0630062	1	W,R	packing ring teflon
8.	0641446	1		counter ring
9.	0465852	1	S, R	gasket
10.	0641445	1		spring
(11.)	0603619	1		gasket
(12.)	0063835	1	W	non-return valve assembly
13.	0646934	1		spring housing
14.	0641445	1		spring
15.	0465852	1	S, R	gasket
16.	0640052	1		sight glass
(17.)	460745	1	R	tension
18.	0647458	1	W	dual piston cpl. consisting of pos. 18.1-18.5
18.1	0647456	1	W	dual piston
18.2	0648573	1		ball guide
18.3	0647394	1	W	cylindrical pin
18.4	0410195	1	W,R	ball
18.5	0618586	1	W	valve screw cpl.
19.	0630103	1		counter ring
20.	0641450	1	W,R	packing ring set mixed consisting of pos. 20.1-20.4
20.1	0627978	1	W,R	packing ring teflon
20.2	0627978	1	W,R	packing ring teflon
20.3	0310425	1	W,R	packing ring leather
20.4	0627978	1	W,R	packing ring teflon
21.	0641444	1		saddle ring
22.	0641452	1		pressure cylinder
23.	0218162	1	S, R	gasket
24.	0641146	1		retaining ring
25.	0641069	1		sleeve
26.	0641129	1	W, R	cylindrical pin
27.	0410225	1	W,R	ball
28.	0605743	1		ball guide
29.	0646635	1	W	valve housing cpl.
30.	0218057	1	S, R	gasket
	0646928		R	seal kit
	0646973			repair kit

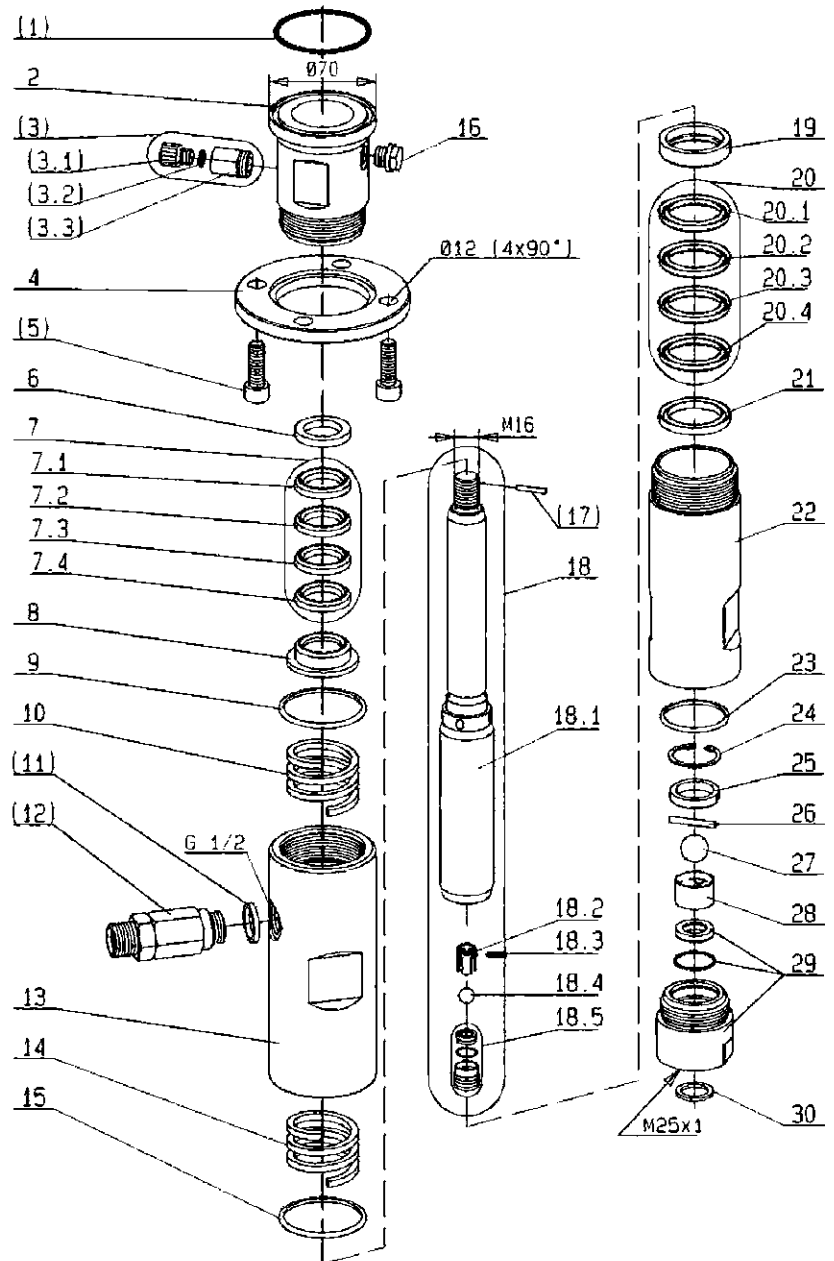

W = Wear part
 S = Included in Seal kit
 R = Included in Repair kit
 Pos. No. marked with () are not part of assembly shown

Dan-Am 2710 medium & 2733 high pressure pump

The Dan-Am Spray-Mix System benefits at a glance:

- High material savings
- The finest atomization generates first class finishes
- Low operating costs due to minimal air consumption
- Soft, controllable spray pattern
- Low pump wear due to low material pressure
- Environmentally friendly due to minimal overspray

Dan-Am 2710 & 2733 pressure pumps

- 2 Pressure ratios choices: Medium 10:1 or High 33:1
- 27 ccm Material delivery per double stroke
- Perfect finishing system for high quality, even finishes
- Ideal for trade and industry:
Cabinet shops, Furniture industry, Paint & Finish shops, Machine construction
- Highly portable for flexible use in almost any location.
- Dual filter system prevents downtime.
- Spring loaded, self-adjusting packings reduce wear and tear.
- Heavy duty housing and a new seal system further improve safety.
- Quick and simple maintenance

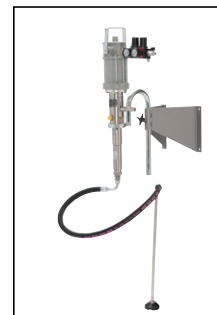

Technical Details

Model	2710	2733
Max. free-flow output in liters/min (gal./min)	4.2 (1.10)	4.2 (1.10)
Pressure ratio	10:01	33:01:00
Output per cycle in ccm (fl.oz.)	27 (0.9)	27 (0.9)
Max. inlet air pressure in bar (psi)	8 (116)	8 (116)
Max. material outlet pressure in bar (psi)	80 (1160)	264 (3830)
Approx. air consumption in liter/min. (cu.ft./min)*	81.6 (2.88)	235 (8.3)
*40 cycles per minute at 6 bar (87 psi) inlet pressure		

Air Assist Pump Systems order form page 190

Hoses pg 167

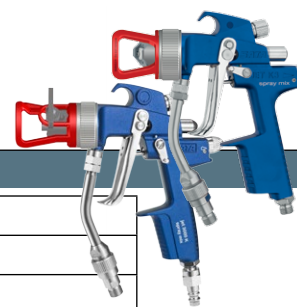

SATAjet 3000 K spray mix

Technical Data

Max. operating pressure atomization air: 10.0 bar / 145 psi
 Max. operating pressure material: 250.0 bar / 3,625 psi
 Weight incl. material filter: 650 g / 23 oz.

Spray mix gun

120006 SATAjet 3000 K spray with paint tube, strainer 100 mesh, and nozzle set (specify material nozzle size)

Spray mix gun w/ Reversing switch

120014 SATAjet 3000 K spray with paint tube, strainer 100 mesh, and reversing nozzle (specify reversing nozzle size)





207530 Reversing switch kit for SATAjet 3000 K spray mix w/out reversing nozzle

Note: Using a reversing nozzle requires a "one time" purchase of the reversing switch. Part Number 207530

See page 20 for nozzle sizes

Dan-Am 2710 & 2733 accessories

10:1 piston pump accessories

0644299	2710, 10:1 pump only	
0661796	2733, 33:1, pump only	
11007	Wall mount unit for high performance pumps	
17483	Cart unit for high performance pumps	
0634509	High pressure filter for high performance pumps	
0163023	M50 (std), orange, HP filter replacement insert	
0160059	M100, black, HP filter replacement insert	
0160628	M150, red, HP filter replacement insert	
0160636	M200, white, HP filter replacement insert	
0163333	Rinsing fluid (Oil), for high performance pumps, throat seal tube	
83840	Stand unit for high performance pumps	
97279	Spray mix dual regulator, single gun connection	
97287	Spray mix triple regulator, dual gun connection	
0498173	5.0 gal / 18.9 l flex tube, standard	
0627401	5.0 gal / 18.9 l flex tube, stainless steel	
Inquire	55.0 gal / 208.1 l flex tube	
640225	25 ft dual high pressure hose	
640250	50 ft dual high pressure hose	
0639123	2 gun material connection	
0643913	Std. inlet suction tube	
0479101	Std. inlet tube sieve	

Additional options and set ups are available. Please inquire for customized spray systems to accommodate your needs.

Parts Dan-Am 2710 & 2733 air motor

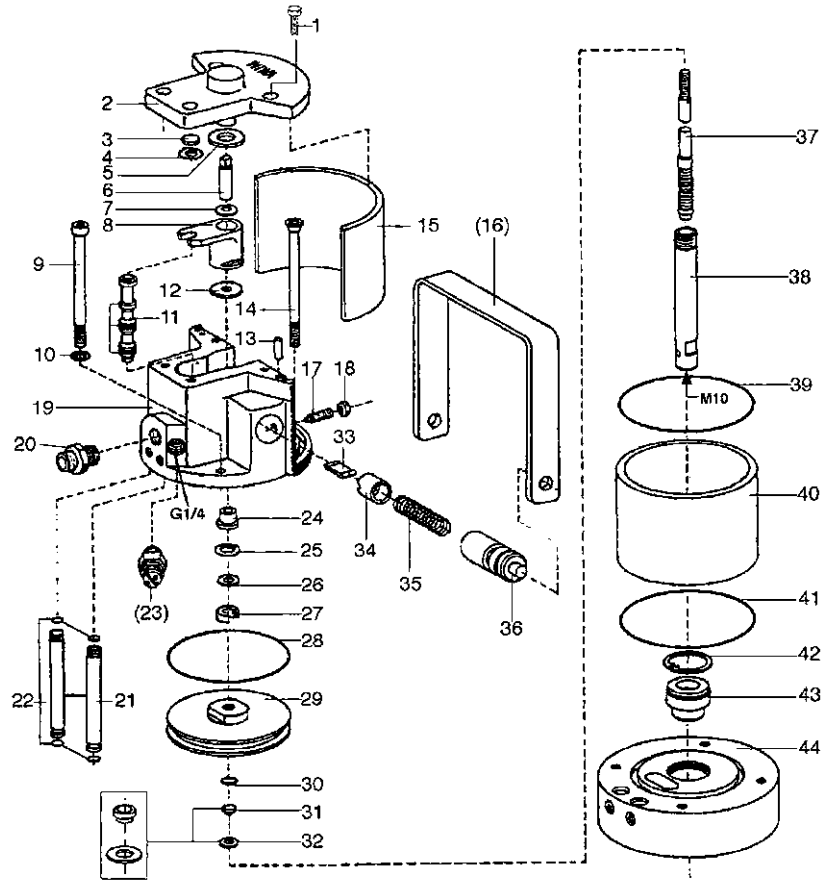

Part No. in Red 33:1 only

Part No. in Green: 10:1 only

Part No. in Black: common

POS	PART NO.	QTY	CODE	DESCRIPTION
1	0460508	4		screw
	0473820	1		cover cpl., pos. 2-4
2	0470309	1		cover
	0470236	1		bush (not illustrated)
3	0470252	1	W, R	dampening spacer
4	0473162	1	R	jagged ring
5	0470279	1	W, R	dampening spacer
6	0470201	1		bolt
7	0470147	1		disc
8	0473111	1	W	carrier cpl.
9	0638922	2		screw
10	0460591	2		washer
11	0473170	1	W, R	control piston cpl.
12	0470287	1	W, R	dampening spacer
13	0473189	2		cylindrical pin
14	0638920	2		screw
15	0470368	1		dampening plate
16	0473200	1		handle
17	0473812	2		threaded pin
18	0460184	2		nut
19	0621498	1		upper part cpl.
20	671034	1		male adaptor
21	0638916	2		air inlet pipe
22	0470392	4	S, R	o-ring
23	0611891	1		safety valve
24	0470155	1		flange sleeve
25	0470384	1	R	retaining ring
26	0476137	1		disc
27	0310204	1	W, S, R	lip seal

POS	PART NO.	QTY	CODE	DESCRIPTION
28	0482609	1	W, S, R	o-ring
28	0478652	1	W, S, R	o-ring
29	0610666	1		piston plate
29	0611271	1		piston plate
30	0310174	1	W, S, R	o-ring
31	0610631	1	R	guide ring
32	0610658	1	R	disc
33	0470325	2	W	toggle
34	0473081	2	W	toggle bearing
35	0617709	2	W	spring
35	0652343	2	W	spring
36	0470171	2		bearing bush
37	0638918	1	W, R	guide axle cpl.
38	0644228	1	W	motor axle
39	0482617	1	S, R	o-ring
39	0310514	1	S, R	o-ring
40	0638919	1	W	cylinder
40	0644230	1	W	cylinder
41	0482617	1	S, R	o-ring
41	0310514	1	R	o-ring
42	0473251	1	R	retaining ring
43	0482625	1	W, S, R	guide bush cpl.
44	0622079	1		bottom cpl.
	0641232		R	Seal kit, 33:1
	0641230		R	Seal kit, 10:1
	0641237			Repair kit, 33:1
	0649499			Repair kit, 10:1

W = Wear part

S = Included in Seal kit

R = Included in Repair kit

Pos. No. marked with () are not part of assembly shown

Parts Dan-Am 2710 & 2733 material pump

POS	PART NO.	QTY	CODE	DESCRIPTION
(1.)	0642643	1		filler neck assembly consisting of pos.(1.1)-(1.4)
(1.1)	0498351	1		extension
(1.2)	0642586	1		T-piece
(1.3)	0642587	2		plug (includes pos.(1.4))
(1.4)	0632184	2	S, R	o-ring
2.	0644213	1		saddle ring
3.	0644380	1	W, R	packing ring set mixed consisting of pos. 3.1-3.2
3.1	0644189	3	W, R	packing ring teflon
3.2	0644182	1	W, R	packing ring leather
4.	0644212	1		counter ring
5.	0644181	2		spring
6.	0644184	1	S, R	o-ring
7.	0644216	1		counter ring
8.	0644381	1	W, R	packing ring set mixed consisting of pos. 8.1-8.2
8.1	0644214	3	W, R	packing ring teflon
8.2	0644183	1	W, R	packing ring leather
9.	0644215	1		saddle ring
10.	0481394	1	W, R	cylindrical pin
11.	0604615	1		ball guide
12.	0631634	1	S, R	o-ring
13.	0411361	1	W	valve seat
(14.)	0644233	1	R	retainer
(15.)	0311928	1	S, R	o-ring
16.	0473537	1		retaining ring
17.	0471658	1		connecting ring
18.	0644238	1		pump head
(19.)	0060585	1	W	non return valve
(20.)	0611778	1	S,R	seal
21.	0644184	1	S, R	o-ring
22.	0644239	1		spring housing
23.	0650183	1		dual piston cpl. consisting of pos. 23.1-23.6
23.1	0644221	1	W	dual piston
23.2	0483664	1	W	ball stop assembly consisting of pos. 23.2.1-23.2.2
23.2.1	0460338	1	W	tension pin
23.2.2	0478806	1		spacer sleeve
23.3	0410187	1	W, R	ball
23.4	0644241	1	S, R	o-ring
23.5	0410527	1	W	valve seat
23.6	0219002	1		threaded plug
24.	0644240	1		pressure cylinder
25.	0641336	1	S, R	o-ring
26.	0410217	1	W, R	ball
27.	0644237	1		valve housing
28.	0218057	1	S, R	seal
	0644382		R	seal kit (standard)
	0644383			repair kit (standard)
	0647019			repair kit (heavy duty)

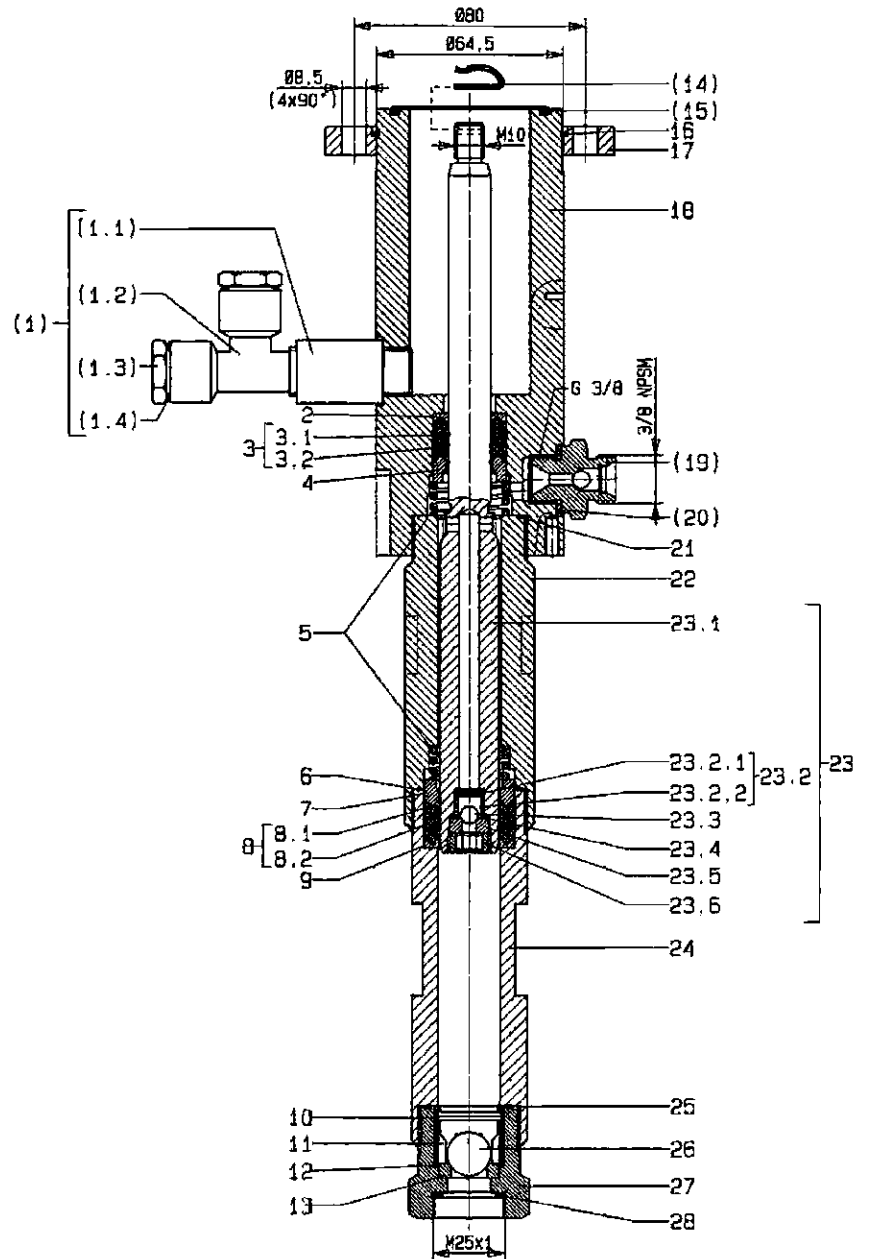

Dan-Am Pump Part Number Order System

DAN-AM AIR ASSIST PUMP SYSTEMS PART NUMBERING SYSTEM

Enter numbers in boxes to calculate our cost.

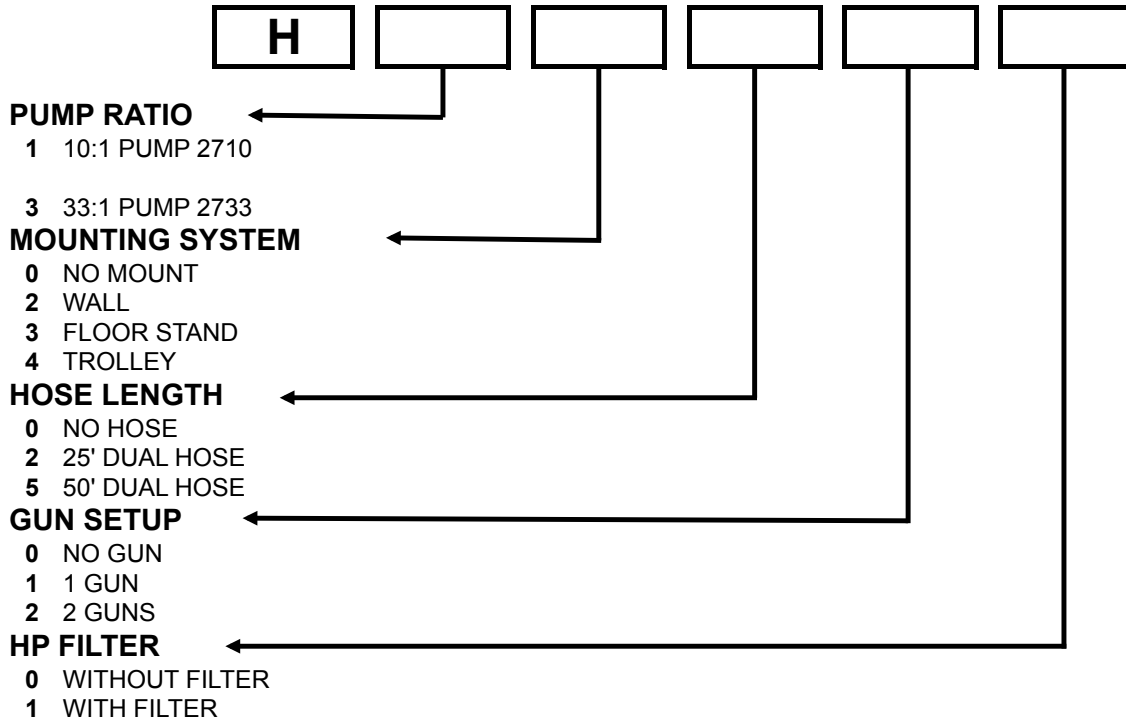

ALL SYSTEMS BEGIN WITH THE LETTER H
ALL SYSTEMS INCLUDE INLET AIR REGULATORS & STANDARD SUCTION TUBE
SYSTEMS WITH GUNS COME WITH THE SATAJET 3000K SPRAY MIX WITH A 3350 NOZZLE
PLEASE SPECIFY IF YOU WOULD LIKE A DIFFERENT NOZZLE SIZE.

Errors, technical modifications and printing errors reserved

Dan-Am 5 gallon agitator lid

Dan-Am 5 gallon agitator lid

- Complete Stainless Steel Construction – Suitable for Waterborne Coatings
- Durable GAST Air Motor construction
- Complete range of speed variability



640100

Dan-Am 5 gallon agitator lid, pail mount



Pail not included



Spare Parts Dan-Am 5 gallon agitator lid

POS	Part No.	Description
1	640100	Agitator Lid complete
2	640110	Air motor 1UP-NCC-1A w/muffler
3	640111	Impeller, ss, w/shaft
4	640112	Coupler, air motor to impeller (not visible)
5	640113	7/8 inch lock collar
6	640114	1 1/4 inch lock collar
7	640115	Air regulator
8	640117	Thumb screw 1/4 x 1 1/4 inch (ea.)
9	640120	14 ga x 5 ft ground wire



Sales and Demo Support

Salesman Ultimate Demo Carrying Case

High-impact Hardigg Storm Case, with retractable pop-up handle and wheels that make it easy to transport. It is watertight, has three comfort grip carrying handles and features press and pull latches. There are 2 different inserts, one for automotive spray guns and accessories and an industrial model that will hold a pressure pot, spray guns and accessories. This attractive case is gray and weighs 19 lbs empty. Measures 19.7" W x 24.6" L x 11.7" H. The SATA Hardigg demo case is sold EMPTY, you specify how to equip it.

IM2720 Demo case with automotive or industrial insert. Please specify insert when ordering.

Equipment *NOT* included



Must request Auto or Industrial case insert

IM2720 Auto Insert



IM2720 Industrial Insert



Aluminum Storage/Carrying Case

Compact aluminum case for jobber salesman, sales rep., or the painter. Compartments for up to 5 SATA spray guns with Sata Adam 2 docks attached, and gravity paint cups. Other compartments for SATA accessories. Locking latch type case with black handle.

Overall size measures 18 W x 13½ D x 6 H. The aluminum case is sold EMPTY. Specify how to equip it.

174128 Aluminum case with foam insert.



Storage/Carrying Case

High impact injection molded plastic case for jobber salesman, sales rep., or the painter. Compartments for up to 5 SATA spray guns with Sata Adam 2 docks attached, and gravity paint cups. Other compartments for SATA accessories. Press and pull latches keep the lid closed. Can be secured with a padlock (not included). Overall size measures 18.5 W x 13½ D x 7 H. The case is sold EMPTY. Specify how to equip it.

630100 Case with foam insert.



Portable SAMS Unit

An ideal system for paint techs, demo salesmen and shops that require a portable supplied air monitoring system. It contains everything necessary to monitor Grade D air – all in a neat Hardigg Storm Case. This quality case features pop-up handles and wheels for easy portability. The unit includes a two or three stage filter depending on the type of belt unit chosen, the battery powered X144 CO monitor, vision 2000 supplied air respirator, 6' ½ inch ID connecting hose, all hardware and 50 feet Premoflex non-gassing breathing air hose.

2720-244 As described above but with 2-stage filter and vision 2000 supplied air respirator with charcoal belt unit.

2720-284 As described above but with 3-stage charcoal filter and vision 2000 supplied air respirator with industrial belt valve.



Errors, technical modifications and printing errors reserved

Dan-Am Paint Suits

Dan-Am Paint Suits

The Dan-Am **Pro-Series** paint suit is expertly designed for fit and movement, with sewn in Carbon Fibre Thread to dissipate electro-static charges which cannot wash out. Made with the finest quality fabric and specially treated to keep it lint free. Comes with the special Mike Elwood design SATA Twisted Fire on the back and SATA spray gun logo on the front. The suit has a covered heavy duty zipper, interior utility pocket, adjustable sleeve and leg velcro closures, wide leg, adjustable elastic waste band for fit and comfort, fully breathable back fabric, 2 utility back pockets, underarm zipper opening for ventilation when needed, bi-swing shoulders for easier movements. Machine washable. *Outperforms disposable coveralls and outlasts them at least ten to one.*

tSGS Tested, ATCC118-2007, Grade 8

(Download SGS test report from www.satausa.com)



Pro Series Dan-Am Paint Suit

510050PS	X-Small
510052PS	Small
510054PS	Medium
510056PS	Large
510058PS	XLarge
510060PS	XXLarge (2XL)
510062PS	XXXLarge (3XL)

Please Note: Order the Pro-Series paint suit as you would your normal size, these run a little larger to fit over your clothing.



Dan-Am Paint Suits

Dan-Am Company offers this high quality paint suit with SATA logo on the front and back. They are made of 100% breathable polyester that offers superior protection over clothing. These paint suits are treated to be anti-static, open at the wrist, ankle and face, available in white or gray. The Dan-Am paint suits are machine washable and available in sizes X-Small to 4XL.

White Dan-Am Paint Suit

530050W	X-Small
530052W	Small
530054W	Medium
530056W	Large
530058W	XLarge (XL)
530060W	XLarge (2XL)
530062W	XXXLarge (3XL)
530064W	XXXXLarge (4XL)



Gray Dan-Am Paint Suits

520052G	Small paint suit
520054G	Medium paint suit
520056G	Large paint suit
520058G	X-Large paint suit (XL)
520060G	XX-Large paint suit (2XL)
520062G	XXX-Large paint suit (3XL)
520064G	XXXX-Large paint suit (4XL)



***Please Note:** This chart is a guide for Dan-Am Paint Suit. Proper fit varies with under clothing and body shape. We recommend ordering *one size larger* after locating your size on the chart.

Errors, technical modifications and printing errors reserved

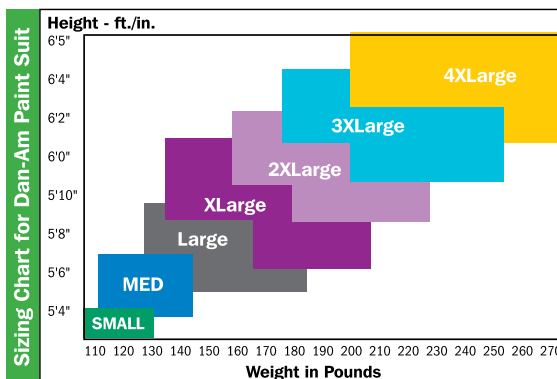

SATAwear & Accessories

SATA Camo t-shirt

You will be styling with a SATA Camo t-shirt
 SATA spray gun inspired classic short sleeve Camo t-shirt with logo.
 Dry-fit moisture wicking, with dual collar and cuffs.

Part No	Sizes
T-XS	Extra small
T-S	Adult small
T-M	Adult medium
T-L	Adult large

Limited sizes, call for availability



Dan-Am /SATA shirts and accessories

BLACK "Twisted Fire" SATA T-SHIRT

This is a one-of-a-kind and limited edition T-shirt was designed by Mike Ellwood of Twisted Designs Airbrush Studio for SATA Spray Equipment/Dan-Am Co. Has a large Twisted fire artwork on back and small SATA logo on front. Shirts are available in black only.
 100% cotton pre-shrunk.

Part No.	Size
TB-S	Adult Small
TB-M	Adult Medium
TB-L	Adult Large

Limited sizes, call for availability



Key Chain

KEY1	SATA KEY CHAIN 5000 B SPRAY GUN
------	--



Golf balls

SW-7004	SATA ULTRA GOLF BALLS Sleeve of 3
---------	---



Caps and Beanies

CAP	Camo Cap
SCAP	Camo Fleece Beanie



Errors, technical modifications and printing errors reserved

Dan-Am Air Compressor

Dan-Am

"Mini Muscle" air compressor

The Dan-Am mini compressor is a rugged and compact portable unit that is ideal for the airbrush artist.

The super quiet 1/6 HP motor powers the twin piston oil-less pump which delivers 1.5 CFM at a maximum pressure of 78 PSI. A regulator with gauge and moisture trap is attached for precise adjustment and clean compressed air. 120 volt with an auto shutoff feature and a nearly 1 gallon storage tank which lessens heat-related moisture build-up, reduces running time, and minimizes motor wear.

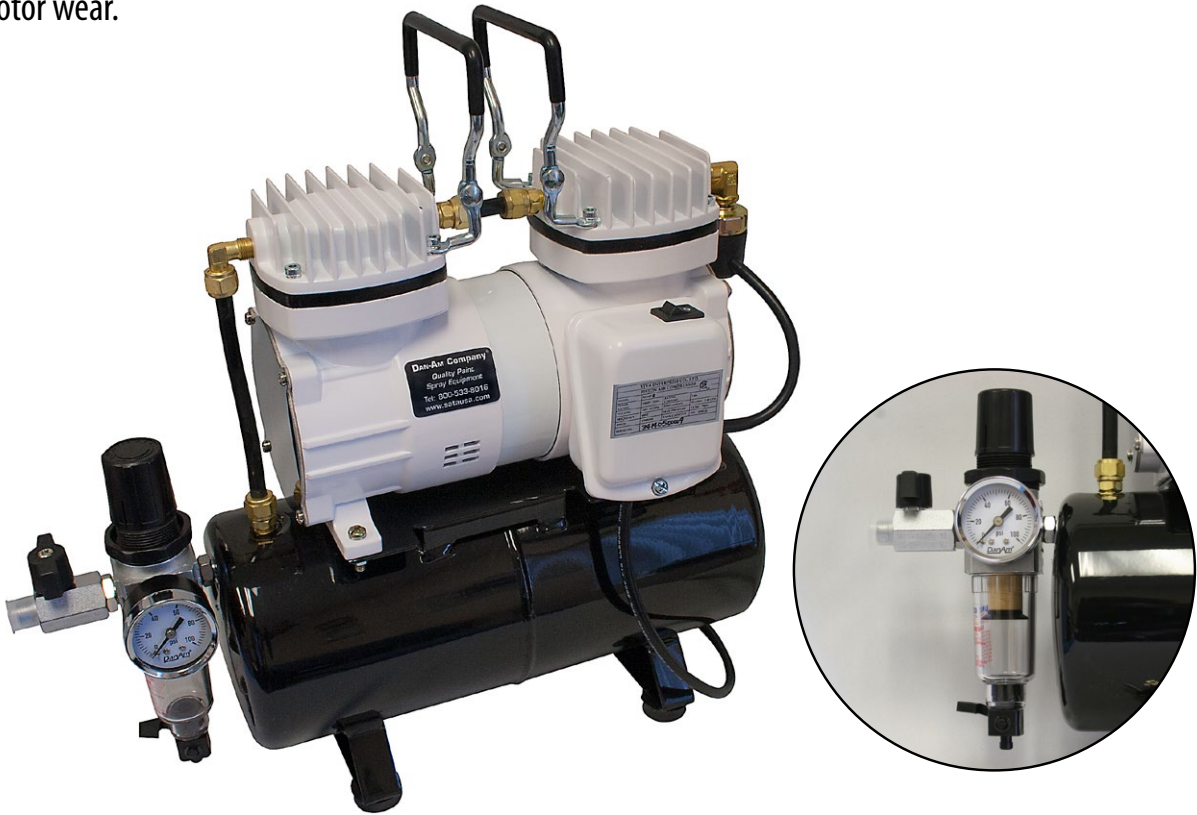

Part No. 677600



Technical Details					
Length	17"	44 cm	Max. Pressure	78 PSI	5.5 BAR
Width	6"	16 cm	Storage Tank	.92 Gal.	3.5 L
Height	12½"	32 cm	Power Rating	120 Volt	
Weight	17½ lb	8 kg		125 Watt	
Air Flow	1.48cfm	42 l/m		1/6 HP	

Errors, technical modifications and printing errors reserved

Dan-Am Pro Stencils.....for painting over dark colors



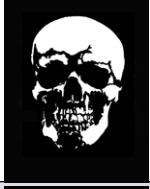
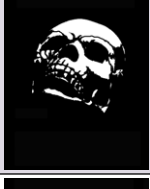

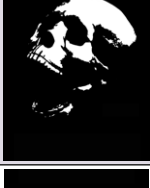
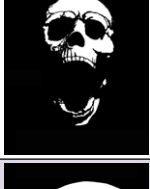
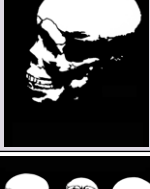
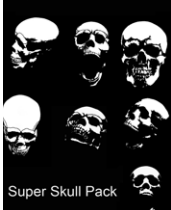
Dan-Am Pro Skull Stencils SERIES 1

The stencils are designed by world-famous artist Mickey Harris. Dan-Am Pro Stencils give the painter or artist the distinct and unique ability to do 3 dimensional appearing work on flat and curved surfaces. **The Skull stencils are designed to be painted on dark backgrounds**, with lighter contrasting colors. Each of the 7 different designs, include **5 sizes in each pack**. Plus we offer a Super Skull Pack which includes 5 sizes of each of the 7 designs. 35 usable stencils in one pack. They are made from 7 mil Mylar, so are very flexible for curved surfaces. They can easily be cleaned with solvent or water, and are very durable to create many great designs with each stencil.

T1	Skull pack 1 Five different sizes	
T2	Skull pack 2 Five different sizes	
T3	Skull pack 3 Five different sizes	
T4	Skull pack 4 Five different sizes	
T5	Skull pack 5 Five different sizes	
T6	Skull pack 6 Five different sizes	
T7	Skull pack 7 Five different sizes	
T8	Super Skull pack This contains 35 stencils. Five different sizes of each,, T1, T2, T3, T4, T5, T6, T7	 Super Skull Pack

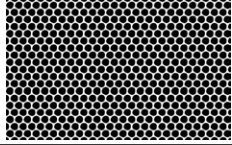
Dan-Am Pro Texture Stencils

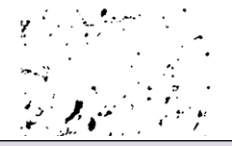
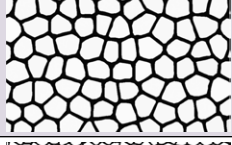
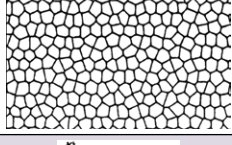
The Pro Texture Stencils by Dan-Am contain 9 great designs to help you build texture and depth into your backgrounds, and in combination with the Pro Series Skull Pack stencils to make the designs your own. We also offer an incredible value kit with all 9 designs, called Mega Texture Kit. These texture stencils help the artists create backgrounds and depth and the stencils can be maneuvered to give a great random appearance but also is easy to duplicate. The Pro Texture Stencils are made of 7 mil Mylar. Flexible for curves and great for flat areas as well. Easily cleaned with solvent or water.

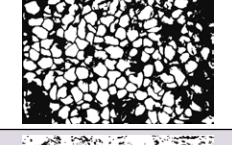
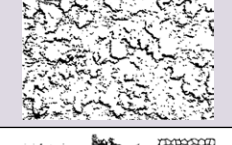
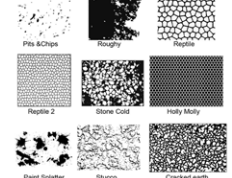
T9	Cracked earth 2 Stencils Approx. size 1) 4" x 5" 1) 8" x 10"	
T10	Holly Molly 2 Stencils Approx. size 1) 4" x 5" 1) 8" x 10"	
T11	Paint Splatter 2 Stencils Approx. size 1) 4" x 5" 1) 8" x 10"	
T12	Pits & Chips 2 Stencils Approx. size 1) 4" x 5" 1) 8" x 10"	
T13	Reptile 2 Stencils Approx. size 1) 4" x 5" 1) 8" x 10"	
T14	Reptile 2 2 Stencils Approx. size 1) 4" x 5" 1) 8" x 10"	
T15	Roughy 2 Stencils Approx. size 1) 4" x 5" 1) 8" x 10"	
T16	Stone Cold 2 Stencils Approx. size 1) 4" x 5" 1) 8" x 10"	
T17	Stucco 2 Stencils Approx. size 1) 4" x 5" 1) 8" x 10"	
T18	Mega Texture Kit 18 Stencils One SET of each; T9, T10, T11, T12, T13, T14, T15, T16, T17	

Errors, technical modifications and printing errors reserved

Dan-Am Pro Stencils

Freehand stencils

Dan-Am Pro freehand stencils and paint masking paper





T19	Necessary Nine, handheld stencil kit	
-----	--------------------------------------	---

Paint Masking

MH4075	Sticky Mickey's Original paint masking paper. 10" x 150'	
--------	---	---

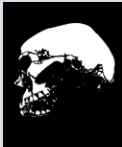

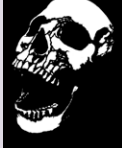

Dan-Am Pro Skull Stencils SERIES 2

Fined detail for use on dark colors using high lights for colors. These stencils are 7 mil mylar and each pack includes 3 sizes. The Skull Collection 2 Mega pack has 3 different sizes in each pack.

T20	Coconut Three different sizes	
T21	Ed The Head Three different sizes	
T22	Gaping Gourd Three different sizes	
T23	Mr. Melon Three different sizes	
T24	Open Dome Three different sizes	
T25	Pumpkin Three different sizes	
T26	Skull 2 Mega Pack This contains 18 stencils. Three different sizes of each, T20, T21, T22, T23, T24, T25	

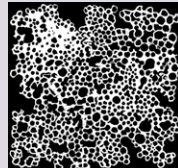



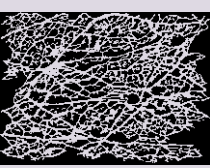
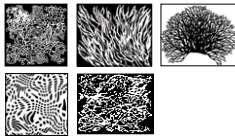





Dan-Am Pro Stencils - Fine Texture Series

Today's demanding artist require a selection of texture stencils capable of creating the most intricate details. Dan-Am has developed a series of the finest super detail organic stencils ever. Designed by Mickey Harris a professional artist for 38 years. There are no better stencils or better priced ones available. made of 7 mil Mylar. Flexible for curves and great for flat areas as well. Easily cleaned with solvent or water.

TF30	Acid Drips 3" x 5"	
TF31	Sea Weed 3" x 5"	
TF32	Tree 3" x 5"	
TF33	Wow Man 3" x 5"	
TF34	Overgrown 3" x 5"	
TF35	Fine Texture Mega Pack Complete set of T30-T34	

Errors, technical modifications and printing errors reserved

Dan-Am How-To Books and DVDs

How-To DVD's and Books		
CDMH1	<p>Beginning Airbrush Techniques for the Automotive Painter: Gun control is essential to achieve professional results; this DVD will get you started right away. This DVD will show you what to practice to gain gun control. Learn the proper way to disassemble, clean and re-assemble your airbrush. Mickey will take you through a project rendering of a granite panel to demonstrate dimension. Approx. *** minutes</p>	
CDMH2	<p>Woodgrain Techniques Mickey's fun loving and engaging teaching style will show you all the latest tricks for automotive woodgraining. Learn the fastest techniques to airbrush knots and knot holes, heavy woodgrain, barn wood, carvings in wood, and tongue and groove. Also cabinet doors and a boss hoss dash demo. Approx. *** minutes All the latest tricks and techniques for automotive WOODGRAINING!</p>	
CDMH3	<p>Prepare to Become a Master of Metal: Mickey will show you techniques, tips, and tricks that will have you painting rivets and metal like a master. Topics covered in this DVD include a demo of the "Resident Evil" car and a Craftsman Series race truck. Mickey will also show you how to do rivets, dents, rips, grinder marks, and distressing. Approx. *** minutes</p>	
430151	<p>Kustom Painting Secrets by Jon Kosmoski Jon Kosmoski has once again teamed up with Tim Remus at Wolfgang Publications, Inc to produce a great new How-To book. He starts with the basics of how to set up a shop, pick a compressor and plumb in new airlines. He covers modern paint technology, and the right equipment to use. Full of great colored pictures of many of his own latest projects, and those of others. It is 144 pages containing a lifetime of Jon's Experience. This is a great book for any painter, and will be a great addition to any vocational schools must-read list.</p>	
MW140	<p>How to Paint Your Motorcycle by JoAnn Bortles, Author JoAnn Bortles covers the latest painting techniques; painting flames, skulls, and murals; candy and pearl paints; and also explains the latest paints and finishes. Even if you don't paint your own bike, this book will provide the information you need to have a professional painter do exactly what you want.</p>	
MW167	<p>How to Custom Paint Your Motorcycle by JoAnn Bortles Author JoAnn Bortles teaches the art of motorcycle painting from top to bottom, from matte black to candy coats, metallic, marblizing, granites, and more. Bortles explains bodywork and molding techniques, setting up your paint area, buying and maintaining your equipment, and choosing the correct paints and finishes</p>	
MW222	<p>How to Custom Paint Your Car by JoAnn Bortles Whether you're flaming a hot rod, putting skulls on a classic lowrider, or simply coating your automobile in a shiny pearl or candy, this book will walk you through every step of the process. Step-by-step, learn how to set up your workshop, choose your tools, and prep your car. Then, from simple to the extraordinary, start working with custom colors, flames, metallic, marbles, custom graphics, and pinstriping</p>	
MW237	<p>How to Master Airbrush Painting Techniques by JoAnn Bortles Expert custom painter and author JoAnn Bortles takes the beginner through the first steps of becoming an airbrush artist. She starts by explaining how to choose and buy equipment, how to master strokes and air pressure, and the materials and accessories a painter will need. And when you're ready to move on to portraits, metal effects, complex stencils, landscapes and more, Bortles gives you the tools to tackle more difficult projects.</p>	
145419	<p>How To Custom Paint Cars, Trucks and Motorcycles by JoAnn Bortles If you're planning a custom build or a new paint job for your favorite ride, this is the place to start. Award-winning painter and author JoAnn Bortles has compiled over 750 photos of dazzling custom paint jobs and drawing on first-hand experience, JoAnn explains the nature of color, graphic patterns, what's pleasing to the eye and what isn't, and how to make the right choice in custom paint.</p>	
Paintable Mini Hoods		
HOOD	<p>Ready to paint, miniature aluminum hood. Approx. size: 24" w x 30" h</p>	
HOODM	<p>Mini-Mini hood, DanAm aluminum miniature hood ready for painting, little smaller than the miniature hood above Approx. size: 14.75" w x 13.10" h</p>	
		

Errors, technical modifications and printing errors reserved

Dan-Am Brochures

Brochures and Leaflets

Order No./Desc.	
1	Binder/Catalog/Price List
2	SATA/Dan-Am Catalog
2A	Numerical Catalog Price Guide
6	SATA News
9	SATA Catalog & Brochures
12	Awesome Paint Jobs Brochure
17	SATAjet 1000 B
19A	SATAjet 100 B Brochure
20	SATAminijet 4400 B Brochure
21	SATAminijet 3000 B Brochure
22	Design Guns Brochure
23	Pressure Fed Guns Brochure
24	Rustproofing Brochure
25	400 Filter System Brochure
26	200 Filter System Brochure
27	SATAminijet 1000 K Brochure
29	Satajet 5000 B Brochure
30	Satajet 4000 B Brochure
31	Air-Star Half Mask Brochure
32	Automatic/ROB Gun Brochure

Order No./Desc.	
33	Piston Pump Brochure
36	Dan-Am Pressure Tank Brochure
38	Vario-Top Pump Brochure
40	Commercial *S*A*M*S Brochure
42	Complete Fresh Air Supply Equip.
43	RPS Dispenser Brochure
44B	SATA cleaning RCS
45	Dry-Jet 2 System Brochure
46	RPS Cup Brochure
47	Adam 2 Digital Micrometer Brochure
48A	DanAm Kneeler
53	Dan-Am Pro Stencils Brochure
54	DanAm Air Vac
55	EZ Flex Paint Stand
57	DanAm Air Catalog
57A	DanAm Air Price list
58	DanAm Air Brochure
59	DAA filtration and layout pads, 1 ea.
60	DanAm Air Ag Brochure
61	DanAm Air Kits
158162	Cleaning and Maintenance of Paint Spray Guns

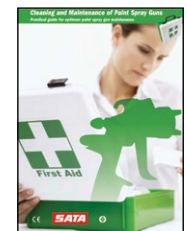

SATA Decals and Posters

6239	SATA Spray Gun Booklet
99671	SATA logo decal 4 x 1.5
99689	SATA logo decal 12 x 4
99697	SATA logo decal 24 x 8
121046	SATA Authorized Dealer 6.5 x 3

61	Respirator Health Protection (Deadman poster)
158162P	Spray Gun Washer & Manual Cleaning Poster - 2 sided, manual and gun washer, 18 x 24
181412	SATA filter 400 cutaway, 24 x 34
215293	SATAjet 5000 B cutaway, 24 x 34
205831	Break down poster - SATA Guns, 34 x 24

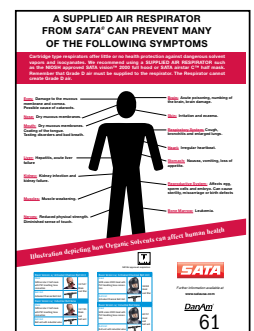

Errors, technical modifications and printing errors reserved

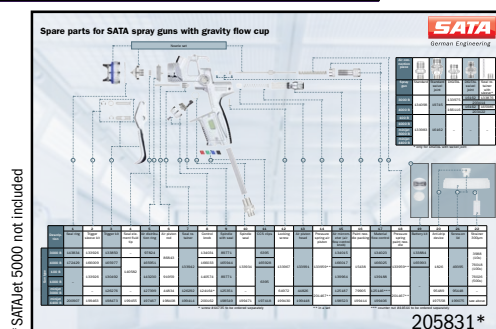

Terms and Conditions of Sale

Important Notice: Sales only to bonafide creditworthy warehouses and jobbers selling paint, spray equipment and service to the automotive, industrial or wood finishing trades. Dan-Am Company reserves the right to refuse sales to companies that do not provide full service before and after the sale. Customers should read and understand the TERMS AND CONDITIONS OF SALE policies of Dan-Am Company below. These TERMS AND CONDITIONS OF SALE are not necessarily the same as Dan-Am Company customers.

We Accept:



Terms for Merchandise Orders:

- To ensure correct billing and shipping, have your account number (customer code number) ready when placing an order. Pricing and other account inquiries will require your account number. Orders may be e-mailed to: order@satausa.com; faxed to: 800-633-7282; or phoned in: 800-533-8016.
- Minimum order – \$50.00 net. Orders less than \$50.00 net will be assessed a \$5.00 handling charge, plus freight.
- Prices are subject to change without notice.
- All orders placed on or before the 24th of the month will be invoiced that same month unless other arrangements are made.
- Special order items from the factory may require full or partial payment in advance.

Terms for Merchandise Returns:

- **Returns** must be authorized with a valid RGA number and sent with a copy of the original invoice to ensure proper credit. Returned equipment must be complete and consist of the original carton, instructions and accessories in unused condition. RGA number must be clearly written on outside of shipping box.
- **Used or abused** equipment is non-returnable.
- **Returned items** will be credited to past due accounts when funds are owed to Dan-Am Company.
- **All returns** are at customer expense unless it is an error in shipping. In that case a call tag will be issued.
- **Accounts** will be assessed a 15% restocking fee. A 2 for 1 reorder accompanying the return may offset the assessment, provided the item(s) are in resalable condition and not used or obsolete.
- **Warranty** claims must be returned to the distributor:
Dan-Am Company, One Sata Drive,
Spring Valley, MN 55975

Shipping Terms:

- All merchandise shipped F.O.B. **Ground delivery freight prepaid to a single destination on a single \$1500.00 net invoice within the continental U.S.** This policy does not include add-on items after invoicing, multiple purchase orders, airfreight, airfreight upgrades or freight that must be sent by truck.
- Minimum order – \$50.00 net. Orders less than \$50.00 net will be assessed a \$5.00 handling charge, plus freight.
- Shipments of \$1500.00 net to Alaska, Hawaii (zone 7) and Puerto Rico (zone 6) will be prepaid to the furthest ground zone. The difference between Air and Ground delivery will be borne by the customer.
- **Freight claims** must be filed within three (3) days from receipt of merchandise.
- **Please Note!** An additional \$5.00 handling fee will be applied after the 5th drop shipment per customer per month. In addition, the actual shipping costs will be added to the drop ship invoice.
- **Please Note!** Customer will be billed for additional freight carrier charges for residential addresses or wrong addresses.

Payment Terms:

- Our month closes on the 24th. Our new month begins on the 25th.
- To insure proper credit to your account, include account number and invoice number(s) with your payment.
- Any purchases during the current month are past due after the 24th of the following month. **YOU ARE ALLOWED A 2% DISCOUNT ONLY IF THE ENVELOPE IS POST MARKED NO LATER THAN THE 10TH, FOLLOWING THE MONTH OF PURCHASE. Do not** deduct 2% if you are not entitled. Equipment returned for credit is not eligible for a 2% discount. **YOU WILL BE REBILLED – NO EXCEPTIONS.** A 1 1/2% finance charge (18% per annum) will be charged to all accounts over 30 days. Minimum monthly finance charge will be \$1.00.
- Do not deduct finance charges for past due invoices.
- Your account will be assessed a \$30.00 fee for any check returned and marked “non-sufficient funds”. The same fee applies to stop payment checks tendered for merchandise delivered or services rendered.
- **PROTECT YOUR CREDIT!** Accounts past due 30 days from date of statement and/or accounts continuously past due are subject to loss of open account privileges and being placed on C.O.D. status.
- Any costs incurred to collect monies due Dan-Am Company by a collection agency will be added to the balance due.

SATA WARRANTY

During the twelve (12) month period from the date of original purchase SATA will repair or, at its option, replace the product without charge for parts or labor subject to the following conditions.

The warranty covers the value for production parts or defects in material during the warranty period. The warranty does not include damages caused by improper handling, normal wear and tear, mechanical damages, faulty assembly, improper maintenance, unusual spray materials or chemicals.

Sprayable abrasive materials reduce the lifetime of valves, packings, guns and nozzles. Wear and tear damage caused by this are not covered in this warranty.

Our units should be inspected upon delivery by the consumer. Obvious damage must be reported within 14 days of receipt of the unit to the supplier to avoid loss of the right to claim notice of defects.

SATA holds itself harmless for damages caused during meetings, training sessions or demonstrations.

Should the consumer require immediate repair or replacement before a determination of whether the affected unit is covered by the warranty, the repair or replacement will be made and charged at the current prices. If it is determined that the item is covered by the warranty, a credit will be issued for repair or replacement. Replaced parts become the property of SATA or their distributor.

Notice of defects or other claims do not entitle the consumer to delay or refuse payment. Returned merchandise to SATA must be sent prepaid. All service charges, freight and handling charges are to be paid by the consumer.

The charges made will be in accordance with the current existing pricing.

Suretyships may not prolong the warranty period. This warranty terminates upon unauthorized interference.

We believe you will agree that the painter is ultimately responsible for the maintenance and mechanical condition of their spray gun.

Warranty work does not include the following:

1. Internal or external cleaning of the spray gun or any part thereof. On warranty claims, your spray gun must be received in clean condition, ready for testing when received in our repair department. Otherwise a \$30.00 minimum charge will be incurred.
2. Damage to any nozzle component caused by vise-grips, pliers, nails, wire or any other foreign object.
3. Damage caused by dropping the spray gun or any nozzle component.
4. Damage caused by the use of abrasive materials.
5. The warranty does not cover damages caused by improper handling, normal wear and tear, mechanical damage, faulty assembly, and improper maintenance.

Warranty does include the following:

1. Defects in production parts or material during the 12 month warranty period.

ALL WARRANTY CLAIMS MUST BE RETURNED TO DAN-AM COMPANY HEADQUARTERS

Contact us:

Toll Free: 800-533-8016

Business Phone: 507-346-7776

Fax: 800-633-SATA (7282)

Int'l Fax: 507-346-7481

e-mail: satajet@satausa.com



DAN-AM CO.®

Exclusive independent importer and distributor of SATA products in the U.S. and Puerto Rico

We Accept:



www.satausa.com

E-Mail: satajet@satausa.com